



British And Metric Adapter Catalog





<p>IA-0PHG-WD BSPP Male Port Plug With Captive Seal</p> <p>Page 16</p>	<p>IA-10BG 60° BSPP Male x BSPP Male Port</p> <p>Page 16</p>	<p>IA-14BG 60° BSPP Male x 45° BSPP Male Adj.</p> <p>Page 16</p>	<p>IA-0CB BSPP Female Cap 60° Cone Seat</p> <p>Page 17</p>	<p>IA-0PB BSPP Male Plug 60° Cone Seat</p> <p>Page 17</p>
<p>IA-0PB-WD BSPP Male Plug Dual Purpose (Captive Seal)</p> <p>Page 17</p>	<p>IA-19BG 60° BSPP Male x 90° BSPP Male Adj.</p> <p>Page 18</p>	<p>IA-ABBG BSPP Male 60° x BSPP Male Adj. Br. Tee</p> <p>Page 18</p>	<p>IA-ABGB 60° BSPP Male x BSPP Male Adj. Run Tee</p> <p>Page 18</p>	<p>IA-20GB BSPP Male Port x BSPP Female Swivel</p> <p>Page 19</p>
<p>IA-24GB 45° BSPP Male Adj. x BSPP Female Swivel</p> <p>Page 19</p>	<p>IA-29GB 90° BSPP Male Adj. x BSPP Female Swivel</p> <p>Page 19</p>	<p>IA-50GB BSPP Port Male x Female Rigid</p> <p>Page 20</p>	<p>IA-59GB BSPP Port Adj. Male x 90° Female Rigid</p> <p>Page 20</p>	<p>IA-10BT BSPP Male x BSPT Male 90° Female Rigid</p> <p>Page 21</p>
<p>IA-14BT BSPP Male x 45° BSPT Male</p> <p>Page 22</p>	<p>IA-19BT BSPP Male x 90° BSPT Male</p> <p>Page 22</p>	<p>IA-ABBT BSPP Male x BSPT Male Br. Tee</p> <p>Page 22</p>	<p>IA-ABTB BSPP Male x BSPT Male Run Tee</p> <p>Page 22</p>	<p>IA-20TB BSPT Male x BSPP Female Swivel</p> <p>Page 23</p>
<p>IA-24TB BSPT Male x 45° BSPP Female Swivel</p> <p>Page 23</p>	<p>IA-29TB 45° BSPT Male x BSPP Female Swivel</p> <p>Page 23</p>	<p>IA-50BT 60° BSPP Male x BSPT Female Rigid</p> <p>Page 23</p>	<p>IA-50TB BSPT Male x BSPP Female Rigid</p> <p>Page 24</p>	<p>IA-54TB BSPT Male x 45° BSPP Female Rigid</p> <p>Page 24</p>
<p>IA-59TB BSPT Male x 90° BSPP Female Rigid</p> <p>Page 24</p>	<p>IA-0PT BSPT Male Plug</p> <p>Page 25</p>	<p>IA-0PHT BSPT Male Plug Allen-Type</p> <p>Page 25</p>	<p>IA-10TT BSPT Male Nipple</p> <p>Page 25</p>	<p>IA-19TT 90° BSPT Male Union</p> <p>Page 26</p>









⚠ WARNING This product can expose you to chemicals, which are known to the State of California to cause cancer or birth defects or other reproductive harm. For more information visit <https://www.p65warnings.ca.gov/>

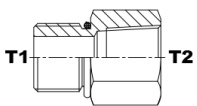
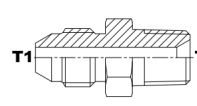
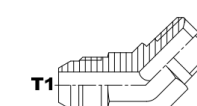
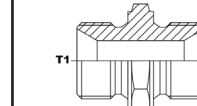
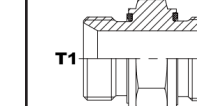
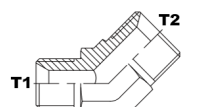
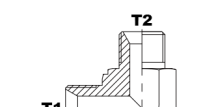
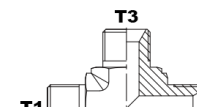
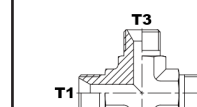
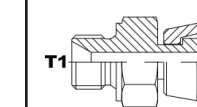
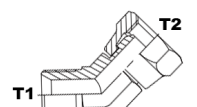
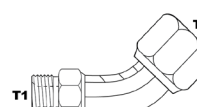
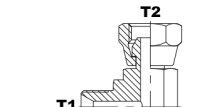

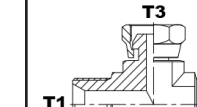
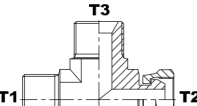
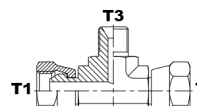
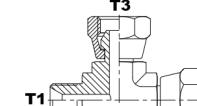
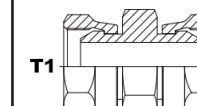
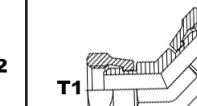
<p>IA-ATTT BSPT Male Tee</p> <p>Page 26</p>	<p>IA-50TT BSPT Male x Female Rigid</p> <p>Page 26</p>	<p>IA-59TT BSPT Male x 90° Female Rigid</p> <p>Page 27</p>	<p>IA-70TT BSPT Female Coupling</p> <p>Page 27</p>	<p>IA-30FB ORFS x BSPP Female Swivel Union</p> <p>Page 28</p>
<p>IA-10BM 60° BSPP Male x Metric Male</p> <p>Page 28</p>	<p>IA-10BM-WD 60° BSPP Male x Metric (Captive Seal)</p> <p><i>*Quoted Upon Request</i></p> <p>Page 29</p>	<p>IA-20MB Metric Male x BSPP Female Swivel</p> <p>Page 29</p>	<p>IA-50BM BSPP Male x Metric Female</p> <p>Page 29</p>	<p>IA-10BH 60° BSPP Male x Metric Port Male</p> <p>Page 30</p>
<p>IA-14BH 60° BSPP Male x 45° Metric Port Adj. Male</p> <p>Page 30</p>	<p>IA-19BH BSPP Male x 90° Metric Port Adj. Male</p> <p>Page 31</p>	<p>IA-ABBH BSPP Male x Metric Port Adj. Male Br. Tee</p> <p>Page 31</p>	<p>IA-ABHB BSPP Male x Metric Port Adj. Male Run Tee</p> <p>Page 31</p>	<p>IA-50GN BSPP Male Port x NPT Female Rigid</p> <p>Page 32</p>
<p>IA-10JG JIC Male x BSPP Port Male</p> <p>Page 32</p>	<p>IA-14JG JIC Male x 45° BSPP Port Adj. Male</p> <p>Page 33</p>	<p>IA-19JG JIC Male x 90° BSPP Port Adj. Male</p> <p>Page 33</p>	<p>IA-AJGG JIC Male x BSPP Port Adj. Male Br. Tee</p> <p>Page 34</p>	<p>IA-AJGJ JIC Male x BSPP Port Adj. Male Run Tee</p> <p>Page 34</p>
<p>IA-20GJ BSPP Male Port x JIC Female Swivel</p> <p>Page 34</p>	<p>IA-29GJ 90° BSPP Male Port Adj. x JIC Female Swivel</p> <p>Page 34</p>	<p>IA-10FG ORFS Male x BSPP Port Male</p> <p>Page 35</p>	<p>IA-14FG ORFS Male x 45° BSPP Port Adj. Male</p> <p>Page 35</p>	<p>IA-19FG ORFS Male x 90° BSPP Port Adj. Male</p> <p>Page 36</p>
<p>IA-AFFG ORFS Male x BSPP Port Adj. Male Br. Tee</p> <p>Page 36</p>	<p>IA-AFGF ORFS Male x BSPP Port Adj. Male Run Tee</p> <p>Page 36</p>	<p>IA-10NT NPT Male x BSPT Male</p> <p>Page 37</p>	<p>IA-50TN BSPT Male x NPT Female Rigid</p> <p>Page 37</p>	<p>IA-50NT NPT Male x BSPT Female Rigid</p> <p>Page 37</p>

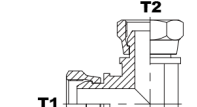
WARNING This product can expose you to chemicals, which are known to the State of California to cause cancer or birth defects or other reproductive harm. For more information visit <https://www.p65warnings.ca.gov/>

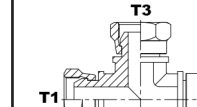
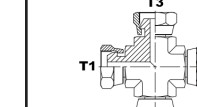
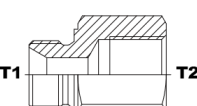

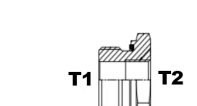
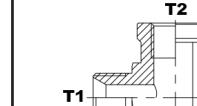
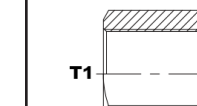
<p>IA-500T M-ORB x BSPT Female Rigid</p>  <p><i>*Quoted Upon Request</i></p> <p>Page 38</p>	<p>IA-10JT JIC Male x BSPT Male</p>  <p>Page 38</p>	<p>IA-14JT JIC Male x 45° BSPT Male</p>  <p>Page 38</p>	<p>IA-10BB BSPP Male Union 60° Seats</p>  <p>Page 39</p>	<p>IA-10BB-WD BSPP Male Union 60° Seats + Captive Seal</p>  <p>Page 40</p>
<p>IA-14BB 45° BSPP Male Union</p>  <p>Page 40</p>	<p>IA-19BB 90° BSPP Male Union</p>  <p>Page 40</p>	<p>IA-ABBB BSPP Male Union Tee</p>  <p>Page 41</p>	<p>IA-XBBBB BSPP Male Union Cross</p>  <p>Page 41</p>	<p>IA-20BB BSPP Male x Female Swivel</p>  <p>Page 42</p>
<p>IA-24BB BSPP Male x 45° Female Swivel</p>  <p>Page 42</p>	<p>IA-24BB-T BSPP Male x 45° Female Swivel Tube Type</p>  <p>Page 43</p>	<p>IA-29BB BSPP Male x 90° Female Swivel</p>  <p>Page 43</p>	<p>IA-29BB-T BSPP Male x 90° Female Swivel Tube Type</p>  <p>Page 43</p>	<p>IA-BBBB BSPP Female Swivel Branch Tee</p>  <p>Page 44</p>
<p>IA-CBBB BSPP Female Swivel Run Tee</p>  <p>Page 44</p>	<p>IA-EBBB BSPP Male Branch Tee</p>  <p>Page 44</p>	<p>IA-FBBB BSPP Male Run Tee</p>  <p>Page 44</p>	<p>IA-30BB BSPP Female Swivel Union</p>  <p>Page 45</p>	<p>IA-34BB 45° BSPP Female Swivel Union</p>  <p>Page 45</p>
<p>IA-34BB-T 45° BSPP Female Swivel Union Tube</p>  <p>Page 45</p>	<p>IA-39BB 90° BSPP Female Swivel Union</p>  <p>Page 46</p>	<p>IA-39BB-T 90° BSPP Female Swivel Union Tube</p>  <p>Page 46</p>	<p>IA-DBBB BSPP Female Swivel Union Tee</p>  <p>Page 46</p>	<p>IA-YBBBB BSPP Female Swivel Cross</p>  <p>Page 46</p>
<p>IA-50BB BSPP Male x Female Rigid</p>  <p>Page 47-48</p>	<p>IA-50BB-WD BSPP Male x Female Rigid + Captive Seal</p>  <p>Page 48</p>	<p>IA-50BB-SB-WD M-BSPP Captive Seal x F-BSPP - Short Body</p>  <p>Page 49</p>	<p>IA-59BB BSPP Male x 90° Female Rigid</p>  <p>Page 49</p>	<p>IA-70BB BSPP Female Rigid Coupling</p>  <p>Page 49</p>

⚠ WARNING This product can expose you to chemicals, which are known to the State of California to cause cancer or birth defects or other reproductive harm. For more information visit <https://www.p65warnings.ca.gov/>



<p>IA-74BB 45° BSPP Female Rigid Coupling</p> <p>Page 50</p>	<p>IA-79BB 90° BSPP Female Rigid Coupling</p> <p>Page 50</p>	<p>IA-GBBB BSPP Female Rigid Union Tee</p> <p>Page 50</p>	<p>IA-40BB BSPP Female Rigid x BSPP Female Swivel</p> <p><i>*Quoted Upon Request</i></p> <p>Page 50</p>	<p>IA-60BB BSPP Male Bulkhead Union</p> <p>Page 51</p>
<p>IA-69BB 90° BSPP Male Bulkhead Union</p> <p>Page 51</p>	<p>IA-0LNB BSPP Male Bulkhead Locknut</p> <p>Page 51</p>	<p>IA-10BN BSPP Male x NPT Male</p> <p>Page 52</p>	<p>IA-14BN BSPP Male x 45° NPT Male</p> <p><i>*Quoted Upon Request</i></p> <p>Page 53</p>	<p>IA-19BN BSPP Male x 90° NPT Male</p> <p>Page 53</p>
<p>IA-20NB NPT Male x BSPP Female Swivel</p> <p>Page 53</p>	<p>IA-24NB NPT Male x 45° BSPP Female Swivel</p> <p><i>*Quoted Upon Request</i></p> <p>Page 54</p>	<p>IA-29NB NPT Male x 90° BSPP Female Swivel</p> <p>Page 54</p>	<p>IA-50NB NPT Male x BSPP Female Rigid</p> <p>Page 54</p>	<p>IA-50BN BSPP Male x NPT Female Rigid</p> <p>Page 55</p>
<p>IA-70BN BSPP Female x NPT Female Rigid</p> <p>Page 55</p>	<p>IA-10BO BSPP Male x M-ORB</p> <p>Page 56</p>	<p>IA-14BO BSPP Male x 45° M-ORB</p> <p>Page 56</p>	<p>IA-19BO BSPP Male x 90° M-ORB</p> <p>Page 56</p>	<p>IA-50BO M-BSPP x ORB Female</p> <p>Page 57</p>
<p>IA-ABBO BSPP Male x M-ORB Br. Tee</p> <p>Page 57</p>	<p>IA-ABOB BSPP Male x M-ORB Run Tee</p> <p>Page 57</p>	<p>IA-20OB M-ORB x BSPP Female Swivel</p> <p>Page 57</p>	<p>IA-24OB M-ORB x BSPP Female Swivel 45°</p> <p>Page 58</p>	<p>IA-29OB M-ORB x BSPP Female Swivel 90°</p> <p>Page 58</p>
<p>IA-50OB M-ORB x BSPP Female Rigid</p> <p>Page 58</p>	<p>IA-10JB JIC Male x BSPP Male 60°</p> <p>Page 59</p>	<p>IA-10JB-BS JIC Male x BSPP Male W/ Bonded Seal</p> <p>Page 60</p>	<p>IA-10JB-WD JIC Male x BSPP Male 60° + Captive Seal</p> <p>Page 60</p>	<p>IA-19JB JIC Male x BSPP Male 90°</p> <p>Page 61</p>



WARNING This product can expose you to chemicals, which are known to the State of California to cause cancer or birth defects or other reproductive harm. For more information visit <https://www.p65warnings.ca.gov/>

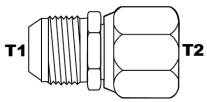
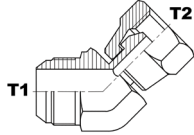
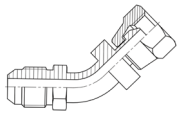
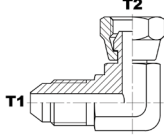
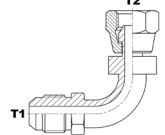
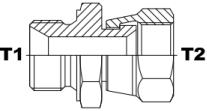
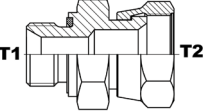
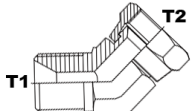
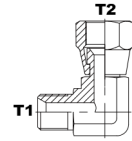
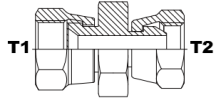
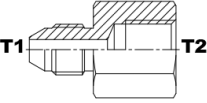
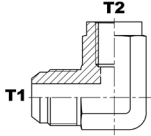
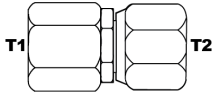
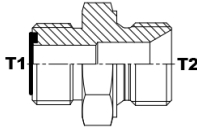
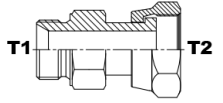
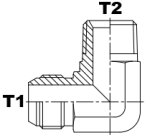
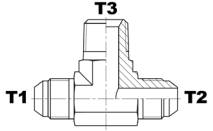
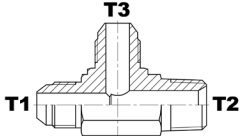
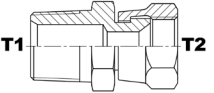
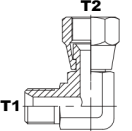
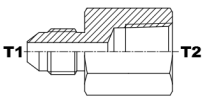
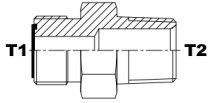
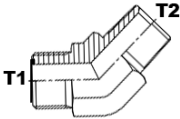
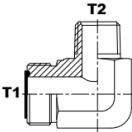
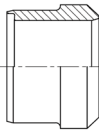
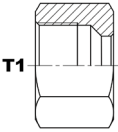
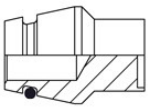
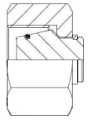
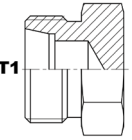
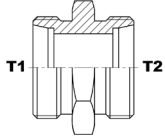

<p>IA-20JB JIC Male x BSPP Female Swivel</p>  <p>Page 61</p>	<p>IA-24JB JIC Male x BSPP Female Swivel 45°</p>  <p>Page 61</p>	<p>IA-24JB-T JIC Male x BSPP Female Swivel 45° Tube</p>  <p>Page 62</p>	<p>IA-29JB JIC Male x 90° BSPP Female Swivel</p>  <p>Page 62</p>	<p>IA-29JB-T JIC Male x 90° BSPP Female Swivel Tube</p>  <p>Page 62</p>
<p>IA-20BJ BSPP Male x JIC Female Swivel</p>  <p>Page 63</p>	<p>IA-20BJ-WD BSPP Male +Captive Seal x JIC Fem. Swivel</p>  <p>Page 63</p>	<p>IA-24BJ BSPP Male x JIC Female Swivel 45°</p>  <p>Page 63</p>	<p>IA-29BJ BSPP Male x 90° JIC Female Swivel</p>  <p>Page 64</p>	<p>IA-30JB JIC Female x BSPP Swivel Union</p>  <p>Page 64</p>
<p>IA-50JB JIC Male x BSPP Female Rigid</p>  <p>Page 64</p>	<p>IA-59JB JIC Male x 90° BSPP Female Rigid</p>  <p>Page 64</p>	<p>IA-40BJ BSPP Female Rigid x JIC Female Swivel</p>  <p>Page 65</p>	<p>IA-10FB ORFS Male x BSPP Male</p>  <p>Page 65</p>	<p>IA-20BF BSPP Male 60° x ORFS Female Swivel</p>  <p>Page 66</p>
<p>IA-19JT JIC Male x 90° BSPT Male</p>  <p>Page 67</p>	<p>IA-AJJT JIC Male x BSPT Male Branch Tee</p>  <p>Page 67</p>	<p>IA-AJTJ JIC Male x BSPT Male Run Tee</p>  <p>Page 67</p>	<p>IA-20TJ BSPT Male x JIC Female Swivel</p>  <p>Page 68</p>	<p>IA-29TJ BSPT Male x 90° JIC Female Swivel</p>  <p>Page 68</p>
<p>IA-50JT JIC Male x BSPT Female Rigid</p>  <p>Page 68</p>	<p>IA-10FT ORFS Male x BSPT Male</p>  <p>Page 69</p>	<p>IA-14FT ORFS Male x 45° BSPT Male</p>  <p>Page 69</p>	<p>IA-19FT ORFS Male x 90° BSPT Male</p>  <p>Page 70</p>	<p>IA-0SA, 0SC, 0SD Din LL, L & S Metric Bite Sleeve</p>  <p>Page 71</p>
<p>IA-0NA, 0NC, 0ND Din LL, L & S Metric Tube Nut</p>  <p>Page 71</p>	<p>IA-0BC, 0BD Din Light & Heavy Blanking Plug</p>  <p>Page 72</p>	<p>IA-0CA, 0CC, 0CD Din LL, L & S Female Cap</p>  <p>Page 72</p>	<p>IA-0PA, 0PC, 0PD Din LL, L & S Male Plug</p>  <p>Page 73</p>	<p>IA-10AA, 10CC, 10DD Din LL, L & S Tube Union</p>  <p>Page 74</p>

⚠ WARNING This product can expose you to chemicals, which are known to the State of California to cause cancer or birth defects or other reproductive harm. For more information visit <https://www.p65warnings.ca.gov/>

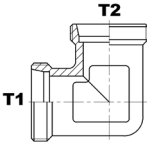
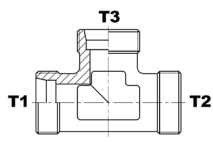
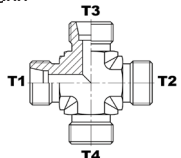
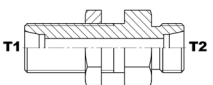
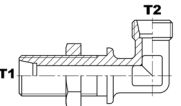

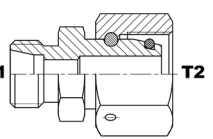
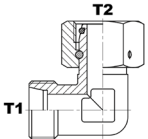
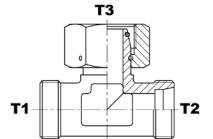
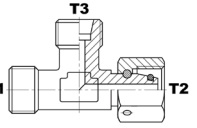
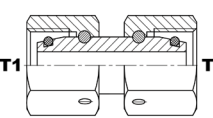
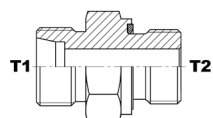
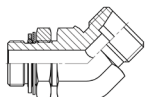
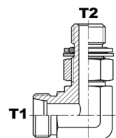
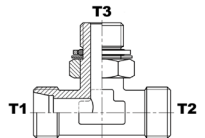
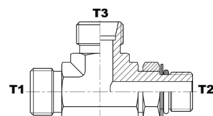
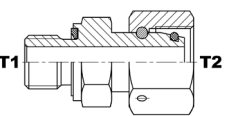
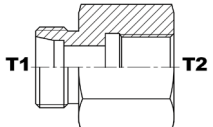
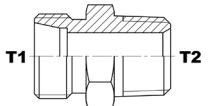
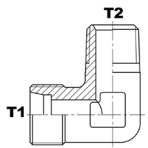
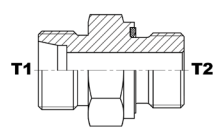
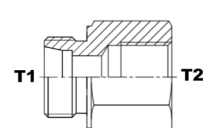
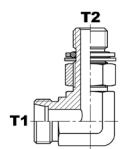
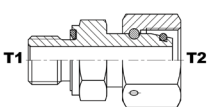
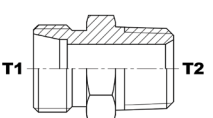
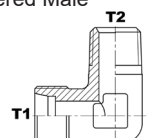
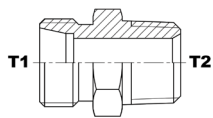
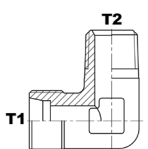
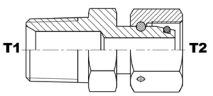
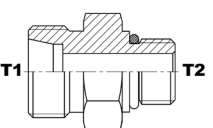





<p>IA-19AA, 19CC, 19DD 90° Din LL, L & S Tube Union</p>  <p>Page 75</p>	<p>IA-AAAA, ACCC, ADDD Din LL, L & S Tube Union Tee</p>  <p>Page 75</p>	<p>IA-XCCCC, XDDDD Din L & S Tube Union Cross</p>  <p>Page 76</p>	<p>IA-60CC, 60DD Din L & S Tube Bulkhead Union W/ Locknut</p>  <p>Page 76</p>	<p>IA-69CC, 69DD 90° Din L & S Tube Bulkhead Union W/ Locknut</p>  <p>Page 77</p>
<p>IA-60CC-W, 60DD-W Din L & S Tube Weld Bulkhead Union</p>  <p><i>*Quoted Upon Request</i> Page 77</p>	<p>IA-20CC, 20DD Din L & S Tube Reducer / Inceaser</p>  <p>Page 78-79</p>	<p>IA-29CC, 29DD 90° Din L & S Female Swivel</p>  <p>Page 80</p>	<p>IA-BCCC, BDDD Din L & S Female Swivel Br. Tee</p>  <p>Page 80</p>	<p>IA-CCCC, CDDD Din L & S Female Swivel Run Tee</p>  <p>Page 81</p>
<p>IA-30CC, 30DD Din L & S Female Swivel Union</p>  <p>Page 81</p>	<p>IA-10AB, 10CB, 10DB-WD Din LL, L & S BSPP Male W/ Seal</p>  <p>Page 82</p>	<p>IA-14CG, 14DG Din L & S x 45° BSPP Male Adj.</p>  <p>Page 83</p>	<p>IA-19CG, 19DG Din L & S x 90° BSPP Male Adj.</p>  <p>Page 83</p>	<p>IA-ACCG, ADDG Din L & S x BSPP Male Adj. Br. Tee</p>  <p>Page 84</p>
<p>IA-ACGC, ADGD Din L & S x BSPP Male Adj. Run Tee</p>  <p>Page 84</p>	<p>IA-20BC-WD, 20BD-WD BSPP Male W/ Seal x Din L & S Fem. Swivel</p>  <p>Page 85</p>	<p>IA-50CB, 50DB Din L & S x BSPP Female Rigid</p>  <p>Page 86</p>	<p>IA-10AT, 10CT, 10DT Din L & S x BSPT Male</p>  <p>Page 87</p>	<p>IA-19AT, 19CT, 19DT Din L & S x 90° BSPT Male</p>  <p>Page 88</p>
<p>IA-10CM-WD, 10DM-WD Din L & S x Metric Port Male</p>  <p>Page 89</p>	<p>IA-50CM, 50DM Din x Metric Female</p>  <p>Page 90</p>	<p>IA-19CH, 19DH Din L & S x 90° Metric Port Adj. Male</p>  <p>Page 90</p>	<p>IA-20MC-WD, 20MD-WD Metric Port Male x Din L & S Swivel</p>  <p>Page 91</p>	<p>IA-10AI, 10CI Din LL & L x Metric Tapered Male</p>  <p><i>*Quoted Upon Request</i> Page 91</p>
<p>IA-19AI, 19CI Din LL & L x 90° Metric Tapered Male</p>  <p><i>*Quoted Upon Request</i> Page 91</p>	<p>IA-10AN, 10CN, 10DN Din LL, L & S x NPT Male</p>  <p>Page 92</p>	<p>IA-19CN, 19DN Din L & S x 90° NPT Male</p>  <p>Page 93</p>	<p>IA-20NC, 20ND NPT Male x DIN L & S</p>  <p>Page 93</p>	<p>IA-10CO, 10DO Din L & S x M-ORB</p>  <p>Page 94</p>

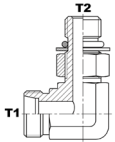
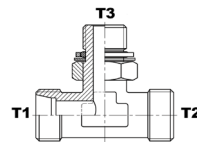
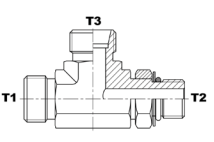

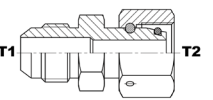
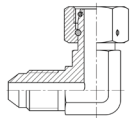

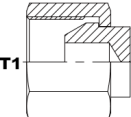
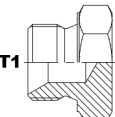
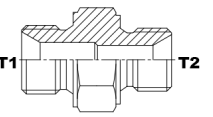
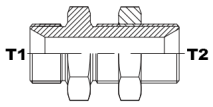
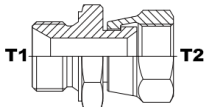
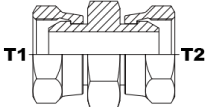
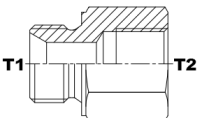
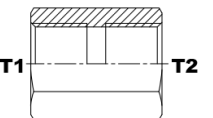
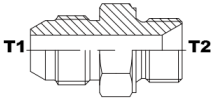
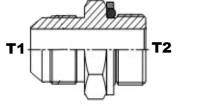
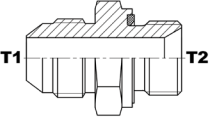
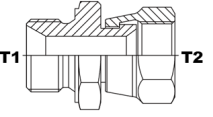
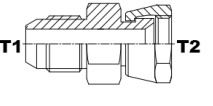
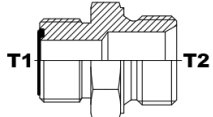
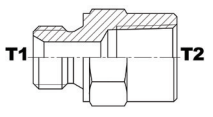
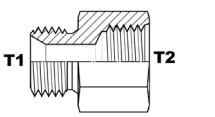
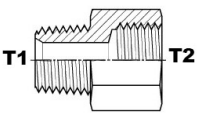
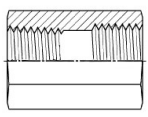

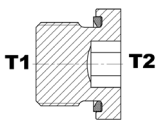
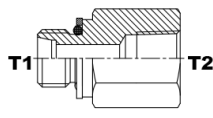
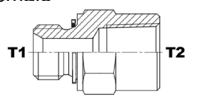
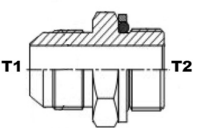



WARNING This product can expose you to chemicals, which are known to the State of California to cause cancer or birth defects or other reproductive harm. For more information visit <https://www.p65warnings.ca.gov/>

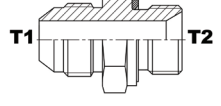
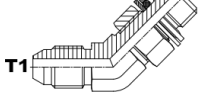
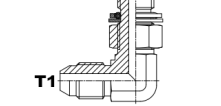
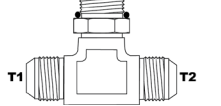
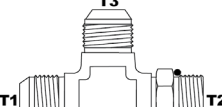
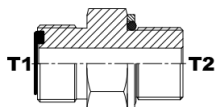
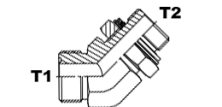
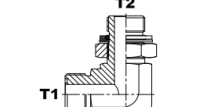
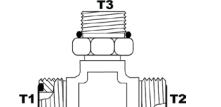
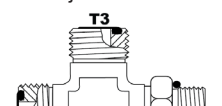
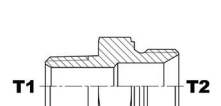
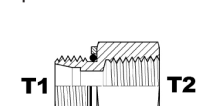
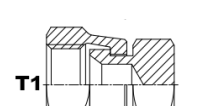
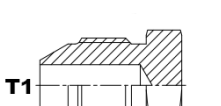
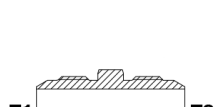
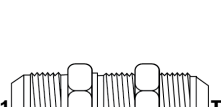
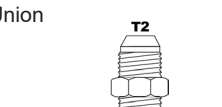
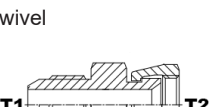

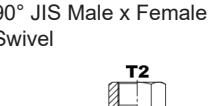
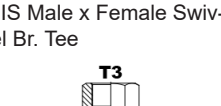
<p>IA-19CO, 19DO Din L & S x 90° M-ORB Adj.</p>  <p>Page 94</p>	<p>IA-ACCO, ADDO Din L & S x M-ORB Adj. Br. Tee</p>  <p>Page 95</p>	<p>IA-ACOC, ADOD Din L & S x M-ORB Adj. Run Tee</p>  <p>Page 95</p>	<p>IA-10JA, 10JC, 10JD JIC Male x Din LL, L & S Male</p>  <p>Page 96</p>	<p>IA-20JA, 20JC, 20JD JIC Male x Din LL, L & S Female Swivel</p>  <p>Page 97</p>
<p>IA-29JC, 29JD 90° JIC Male x Din Female Swivel</p>  <p>Page 98</p>	<p>IA-10JV JIC Male x Metric Stand Pipe</p>  <p>Page 98</p>	<p>IA-0CM Metric 60° Cone Seat Female Cap</p>  <p>Page 99</p>	<p>IA-0PM Metric 60° Cone Seat Male Plug</p>  <p>Page 99</p>	<p>IA-10MM Metric Male Union</p>  <p>Page 100</p>
<p>IA-60MM Metric Male Bulkhead Union W/ Locknut</p>  <p>Page 100</p>	<p>IA-20MM Metric Male x Female Swivel</p>  <p>Page 100</p>	<p>IA-30MM Metric Female Swivel Union</p>  <p>Page 101</p>	<p>IA-50MM Metric Male x Female Rigid</p>  <p>Page 101</p>	<p>IA-70MM Metric Female Coupling Rigid</p>  <p>Page 101</p>
<p>IA-10JM JIC Male x Metric Male</p>  <p>Page 102</p>	<p>IA-10JM-BS JIC Male x Metric Male W/ Bonded Seal</p>  <p>Page 103</p>	<p>IA-10JM-WD JIC Male x Metric Male + Captive Seal</p>  <p>Page 103</p>	<p>IA-20MJ Metric Male x Female JIC Swivel</p>  <p>Page 103</p>	<p>IA-20JM JIC Male x Metric Female Swivel</p>  <p>Page 104</p>
<p>IA-10FM ORFS Male x Metric 60° Male</p>  <p>Page 104</p>	<p>IA-50NM Metric Male x NPT Female</p>  <p>Page 105</p>	<p>IA-50MO Metric Male x ORB Female</p>  <p>Page 105</p>	<p>IA-50NM NPT Male x Metric Female</p>  <p>Page 105</p>	<p>IA-70NM NPT Female x Metric Female</p>  <p>Page 106</p>
<p>IA-0LNM Metric Bulkhead Locknut</p>  <p>Page 106</p>	<p>IA-0PHH-WD Metric Port Plug (Captive Seal)</p>  <p>Page 107</p>	<p>IA-50HN Metric Port Male x NPT Female Rigid</p>  <p>Page 107</p>	<p>IA-50HN-BS Male-Metric Port W/ Bonded Seal x NPT Female</p>  <p>Page 108</p>	<p>IA-10JH JIC Male x Metric Port Male</p>  <p>Page 108</p>

⚠ WARNING This product can expose you to chemicals, which are known to the State of California to cause cancer or birth defects or other reproductive harm. For more information visit <https://www.p65warnings.ca.gov/>

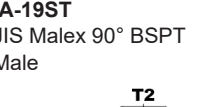
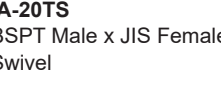

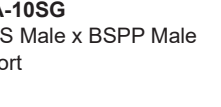

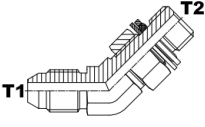
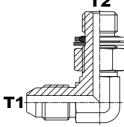
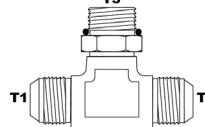
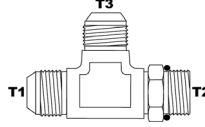
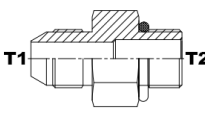
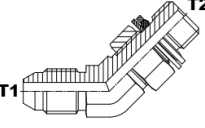
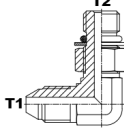
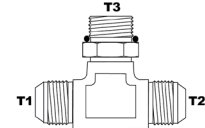
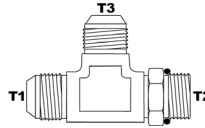
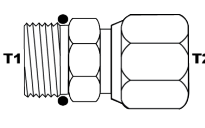
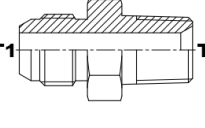
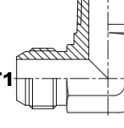
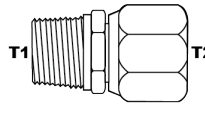
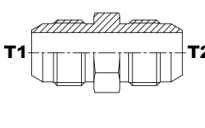
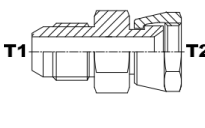
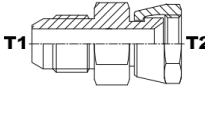
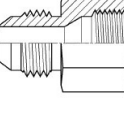
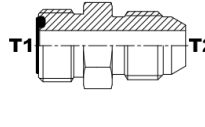
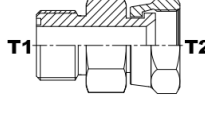
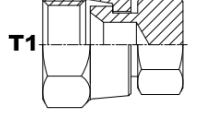
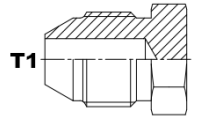
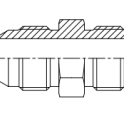
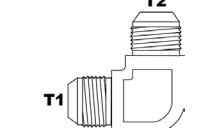
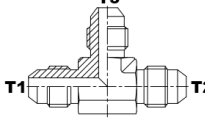
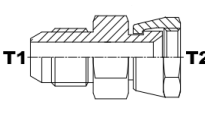
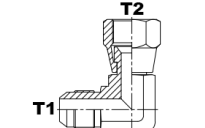
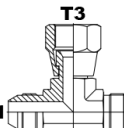
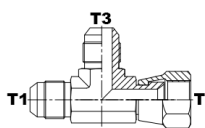
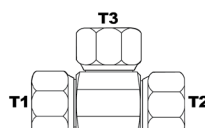
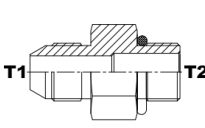

<p>IA-10JH-BS JIC Male x Male-Metric Port W/ Bonded Seal</p>  <p>Page 109</p>	<p>IA-10JH-WD JIC Male x Male-Metric Port Captive Seal</p>  <p>Page 109</p>	<p>IA-14JH JIC Male x 45° Metric Port Male Adj.</p>  <p>Page 109</p>	<p>IA-19JH JIC Male x 90° Metric Port Male Adj.</p>  <p>Page 110</p>	<p>IA-AJHJ JIC Male x Metric Port Male Adj. Br. Tee</p>  <p>Page 110</p>
<p>IA-AJHJ JIC Male x Metric Port Male Adj. Run Tee</p>  <p>Page 111</p>	<p>IA-10FH ORFS Male x Metric Port Male</p>  <p>Page 111</p>	<p>IA-14FH ORFS Male x 45° Metric Port Male Adj.</p>  <p>Page 112</p>	<p>IA-19FH ORFS Male x 90° Metric Port Male Adj.</p>  <p>Page 112</p>	<p>IA-AFFH ORFS Male x Metric Port Male Adj. Br. Tee</p>  <p>Page 112</p>
<p>IA-AFHF ORFS Male x Metric Port Male Adj. Run Tee</p>  <p>Page 113</p>	<p>IA-10NH NPT Male x Male-Metric Port</p>  <p>Page 113</p>	<p>IA-50HN-DP Male-Metric Dual Purpose x NPT Female</p>  <p>Page 113</p>	<p>IA-0CS JIS Female Cap</p>  <p>Page 114</p>	<p>IA-0PS JIS Male Plug</p>  <p>Page 114</p>
<p>IA-10SS JIS Male Union</p>  <p>Page 114</p>	<p>IA-60SS JIS Male Bulkhead Union</p>  <p>Page 114</p>	<p>IA-69SS 90° JIS Male Bulkhead Union</p>  <p>Page 115</p>	<p>IA-20SS JIS Male x Female Swivel</p>  <p>Page 115</p>	<p>IA-24SS JIS Male x 45° Female Swivel</p>  <p>Page 115</p>
<p>IA-29SS 90° JIS Male x Female Swivel</p>  <p>Page 115</p>	<p>IA-BSSS JIS Male x Female Swivel Br. Tee</p>  <p>Page 116</p>	<p>IA-CSSS JIS Male x Female Swivel Run Tee</p>  <p>Page 116</p>	<p>IA-10ST JIS Male x BSPT Male</p>  <p>Page 116</p>	<p>IA-14ST JIS Male x 45° BSPT Male</p>  <p>Page 117</p>
<p>IA-19ST JIS Male x 90° BSPT Male</p>  <p>Page 117</p>	<p>IA-20TS BSPT Male x JIS Female Swivel</p>  <p>Page 117</p>	<p>IA-50ST JIS Male x BSPT Female Rigid</p>  <p>Page 118</p>	<p>IA-10SB JIS Male x BSPP Male 60° Seat</p>  <p>Page 118</p>	<p>IA-10SG JIS Male x BSPP Male Port</p>  <p>Page 118</p>

WARNING This product can expose you to chemicals, which are known to the State of California to cause cancer or birth defects or other reproductive harm. For more information visit <https://www.p65warnings.ca.gov/>

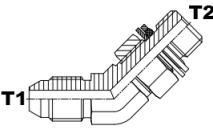
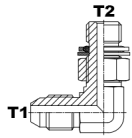
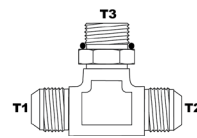
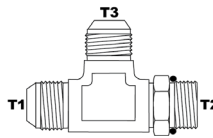
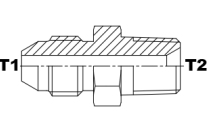
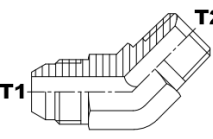
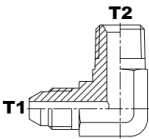
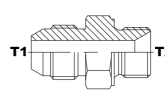
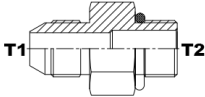
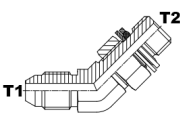
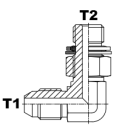
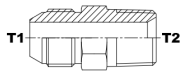
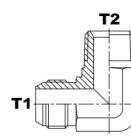
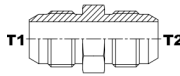
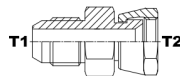
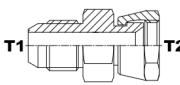
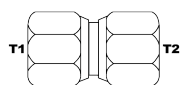
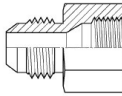
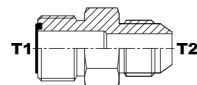
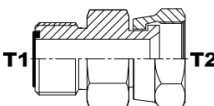

<p>IA-14SG 45° JIS Male x BSPP Port Adj. Male</p>  <p>Page 118</p>	<p>IA-19SG JIS Male x 90° BSPP Port Male Adj.</p>  <p>Page 119</p>	<p>IA-ASSG JIS Male x BSPP Port Male Adj. Br. Tee</p>  <p>Page 119</p>	<p>IA-ASGS JIS Male x BSPP Port Male Adj. Run Tee</p>  <p>Page 119</p>	<p>IA-10SO JIS Male x ORB Male</p>  <p>Page 119</p>
<p>IA-14SO JIC Male x 45° M-ORB Adj.</p>  <p>Page 120</p>	<p>IA-19SO JIS Male x 90° M-ORB Adj.</p>  <p>Page 120</p>	<p>IA-ASSO JIS Male x M-ORB Adj. Br. Tee</p>  <p>Page 120</p>	<p>IA-ASOS JIS Male x M-ORB Adj. Run Tee</p>  <p>Page 120</p>	<p>IA-20OS M-ORB x JIS Female Swivel</p>  <p>Page 121</p>
<p>IA-10SN JIS Male x NPT Male</p>  <p>Page 121</p>	<p>IA-19SN JIS Male x 90° NPT Male</p>  <p>Page 121</p>	<p>IA-20NS NPT Male x JIS Female Swivel</p>  <p>Page 122</p>	<p>IA-10JS JIC Male x JIS Male</p>  <p>Page 122</p>	<p>IA-20SJ JIS Male x JIC Female Swivel</p>  <p>Page 122</p>
<p>IA-20JS JIC Male x JIS Female Swivel</p>  <p>Page 122</p>	<p>IA-50JS JIC Male x JIS Female</p>  <p>Page 123</p>	<p>IA-10FS ORFS Male x JIS Male</p>  <p>Page 123</p>	<p>IA-20FS ORFS Male x JIS Fe- male Swivel</p>  <p>Page 123</p>	<p>IA-0CK Komatsu® Female Cap</p>  <p>Page 124</p>
<p>IA-0PK Komatsu® Male Plug</p>  <p>Page 124</p>	<p>IA-10KK Komatsu® Male Union</p>  <p>Page 124</p>	<p>IA-19KK 90° Komatsu® Male Union</p>  <p>Page 124</p>	<p>IA-AKKK Komatsu® Male Union Tee</p>  <p>Page 125</p>	<p>IA-20KK Komatsu® Male x Female Swivel</p>  <p>Page 125</p>
<p>IA-29KK Komatsu® Male x 90° Female Swivel</p>  <p>Page 125</p>	<p>IA-BKKK Komatsu® Male x Female Swivel Br. Tee</p>  <p>Page 125</p>	<p>IA-CKKK Komatsu® Male x Female Swivel Run Tee</p>  <p>Page 126</p>	<p>IA-DKKK Komatsu® Female Swivel Tee</p>  <p>Page 126</p>	<p>IA-10KH Komatsu® Male x Metric Port Male</p>  <p>Page 126</p>

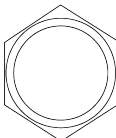
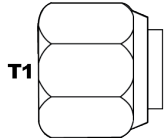
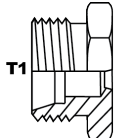
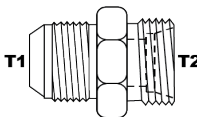
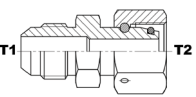
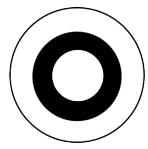
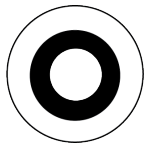





⚠ WARNING This product can expose you to chemicals, which are known to the State of California to cause cancer or birth defects or other reproductive harm. For more information visit <https://www.p65warnings.ca.gov/>

<p>IA-14KH Komatsu® Male x 45° Metric Port Male Adj.</p>  <p>Page 126</p>	<p>IA-19KH Komatsu® Male x 90° Metric Port Male Adj.</p>  <p>Page 127</p>	<p>IA-AKKH Komatsu® Male x Metric Port Male Br. Tee</p>  <p>Page 127</p>	<p>IA-AKHK Komatsu® Male x Metric Port Male Run Tee</p>  <p>Page 127</p>	<p>IA-10KT Komatsu® Male x BSPT Male</p>  <p>Page 127</p>
<p>IA-14KT Komatsu® Male x 45° BSPT Male</p>  <p>Page 128</p>	<p>IA-19KT Komatsu® Male x 90° BSPT Male</p>  <p>Page 128</p>	<p>IA-10KB Komatsu® Male x BSPP Male</p>  <p>Page 128</p>	<p>IA-10KG Komatsu® Male x BSPP Male Port</p>  <p>Page 128</p>	<p>IA-14KG Komatsu® Male x 45° BSPP Male Port Adj.</p>  <p>Page 129</p>
<p>IA-19KG Komatsu® Male x 90° BSPP Male Port Adj.</p>  <p>Page 129</p>	<p>IA-10KN Komatsu® Male x NPT Male</p>  <p>Page 129</p>	<p>IA-19KN Komatsu® Male x 90° NPT Male</p>  <p>Page 130</p>	<p>IA-10JK JIC Male x Komatsu® Male</p>  <p>Page 130</p>	<p>IA-20KJ Komatsu® Male x JIC Female Swivel</p>  <p>Page 130</p>
<p>IA-20JK JIC Male x Komatsu® Female Swivel</p>  <p>Page 130</p>	<p>IA-30JK JIC x Komatsu® Female Swivel</p>  <p>Page 131</p>	<p>IA-50JK JIC Male x Komatsu® Female</p>  <p>Page 131</p>	<p>IA-10FK ORFS Male x Komatsu® Male</p>  <p>Page 131</p>	<p>IA-20FK ORFS Male x Komatsu® Female Swivel</p>  <p>Page 131</p>
<p>IA-0SX Kobelco® Metric Tube Bite Sleeve</p>  <p>Page 132</p>	<p>IA-0NX Kobelco® Metric Tube Nut</p>  <p>Page 132</p>	<p>IA-0CX Kobelco® Female Cap</p>  <p>Page 132</p>	<p>IA-0PX Kobelco® Male Plug</p>  <p>Page 132</p>	<p>IA-10JX JIC Male x Kobelco® Male</p>  <p>Page 133</p>
<p>IA-20JX JIC Male x Kobelco® Female</p>  <p>Page 133</p>	<p>IA-BBS BSP Bonded Seal</p>  <p>Page 134</p>	<p>IA-MBS Metric Bonded Seal</p>  <p>Page 134</p>	<p>IA-BRR BSPP Retaining Ring</p>  <p>Page 135</p>	<p>IA-BOR BSPP O-Ring</p>  <p>Page 135</p>

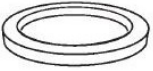
WARNING This product can expose you to chemicals, which are known to the State of California to cause cancer or birth defects or other reproductive harm. For more information visit <https://www.p65warnings.ca.gov/>

QUICK REFERENCE CHART

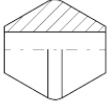
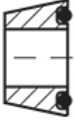

<p>IA-MRR Metric Retaining Ring</p>  <p>Page 135</p>	<p>IA-MOR Metric O-Ring</p>  <p>Page 136</p>	<p>IA-BCS BSPP Captive Seal</p>  <p>Page 136</p>	<p>IA-MCS Metric Captive Seal</p>  <p>Page 136</p>	<p>IA-DOR Din Cone O-Ring (DKO)</p>  <p>Page 137</p>
<p>IA-SOR JIS Port O-Ring</p>  <p>Page 137</p>	<p>IA-0XBS BSPP To JIS Conversion Seat</p>  <p>Page 138</p>	<p>IA-0XFS BSPP FF To JIS Conversion Seat</p>  <p>Page 138</p>		

WARNING This product can expose you to chemicals, which are known to the State of California to cause cancer or birth defects or other reproductive harm. For more information visit <https://www.p65warnings.ca.gov/>

International Thread Chart

		DIN LL	DIN LIGHT	DIN HEAVY	JIS (TUBE)	JIS (PIPE)	Kobelco	French GAZ
Tube/Pipe			CEL	CES			French Millimétrique	(PIPE)
Size		DKLL-CELL	DKL,DKOL	DKS,DKOS			FKB - MKB	DKZ-CEZ
"mm"	Type Code	A	C	D	S	Z	X	Y
4		M 8X1.0			M10X1.25			
6		M10X1.0	M12X1.5	M14X1.5	M12X1.5	M12X1.5	M12X1.0	
8		M12X1.0	M14X1.5	M16X1.5	M14X1.5	M14X1.5	M14X1.5	
10		M14X1.0	M16X1.5	M18X1.5	M16X1.5	M16X1.5	M16X1.5	
10.5						M16X1.5		
12		M16X1.0	M18X1.5	M20X1.5	M18X1.5	M18X1.5	M18X1.5	
13.25								M20X1.5
13.8						M20X1.5		
14				M22X1.5			M20X1.5	
15			M22X1.5		M22X1.5	M22X1.5	M22X1.5	
16				M24X1.5	M24X1.5	M24X1.5	M24X1.5	
16.75								M24X1.5
17.3						M26X1.5		
18			M26X1.5		M26X1.5	M26X1.5	M27X1.5	
20				M30X2.0	M28X1.5	M28X1.5	M27X1.5	
21.25								M30X1.5
21.7						M30X1.5		
22			M30X2.0		M30X1.5	M30X1.5	**M30X1.5	
25				M36X2.0	M35X1.5	M35X1.5	M33X1.5	
26.75								M36X1.5
27.2						M38X1.5		
28			M36X2.0		M38X1.5	M38X1.5	**M36X1.5	
30				M42X2.0	M40X1.5	M40X1.5	M39X1.5	
32					M42X1.5	M42X1.5	M42X1.5	
33.5								M45X1.5
34						M45X1.5		
35			M45X2.0		M45X1.5	M45X1.5	**M45X1.5	
38				M52X2.0	M48X1.5	M48X1.5	M48X1.5	
40					M52X2.0	M52X2.0	M52X1.5	
42			M52X2.0		M52X2.0	M52X2.0		
42.25								M52X1.5
42.7						M56X2.0		
45							M54X2.0	
48							M58X2.0	
48.25								M58X2.0
48.6						M64X2.0		
50					M62X2.0	M64X2.0		

 **WARNING** This product can expose you to chemicals, which are known to the State of California to cause cancer or birth defects or other reproductive harm. For more information visit <https://www.p65warnings.ca.gov/>





Metric Thread Chart - 60° & Port

Dash Size	Thread Pitch	Male O.D. (mm)	Female I.D. (mm)
8	1.0	8	6.5
10	1.0	10	8.5
10A	1.25	10	8.5
10B	1.5	10	8.5
12A	1.0	12	10.5
12B	1.25	12	10.5
12	1.5	12	10.5
14	1.5	14	12.5
16	1.5	16	14.5
18	1.5	18	16.5
20	1.5	20	18.5
22	1.5	22	20.5
24	1.5	24	22.5
26	1.5	26	24.5
27D	1.5	27	25.5
27	2.0	27	25.5
30D	1.5	30	28
30	2.0	30	28
33D	1.5	33	31
33	2.0	33	31
36	2.0	36	34
39	2.0	39	37
42	2.0	42	40
45	2.0	45	43
48	2.0	48	46
52	2.0	52	50
60	2.0	60	58
64	2.0	64	62

BSPP & BSPT Thread Chart

Inch Size	Dash Size	Nominal Thread Size	Male Thread O.D.	Female Thread O.D.
1/8	-02	1/8 - 28	3/8 (0.38")	11/32 (0.35")
1/4	-04	1/4 - 19	33/64 (0.52")	15/32 (0.47")
3/8	-06	3/8 - 19	21/32 (0.65")	19/32 (0.60")
1/2	-08	1/2 - 14	13/16 (0.82")	3/4 (0.75")
5/8	-10	5/8 - 14	7/8 (0.88")	13/16 (0.80")
3/4	-12	3/4 - 14	1 1/32 (1.04")	31/32 (0.97")
1	-16	1 - 11	1 5/16 (1.30")	1 7/32 (1.22")
1 1/4	-20	1 1/4 - 11	1 21/32 (1.65")	1 9/16 (1.56")
1 1/2	-24	1 1/2 - 11	1 7/8 (1.88")	1 25/32 (1.79")
2	-32	2 - 11	2 11/32 (2.35")	2 1/4 (2.26")



WARNING This product can expose you to chemicals, which are known to the State of California to cause cancer or birth defects or other reproductive harm. For more information visit <https://www.p65warnings.ca.gov/>

British & Metric Part Number System

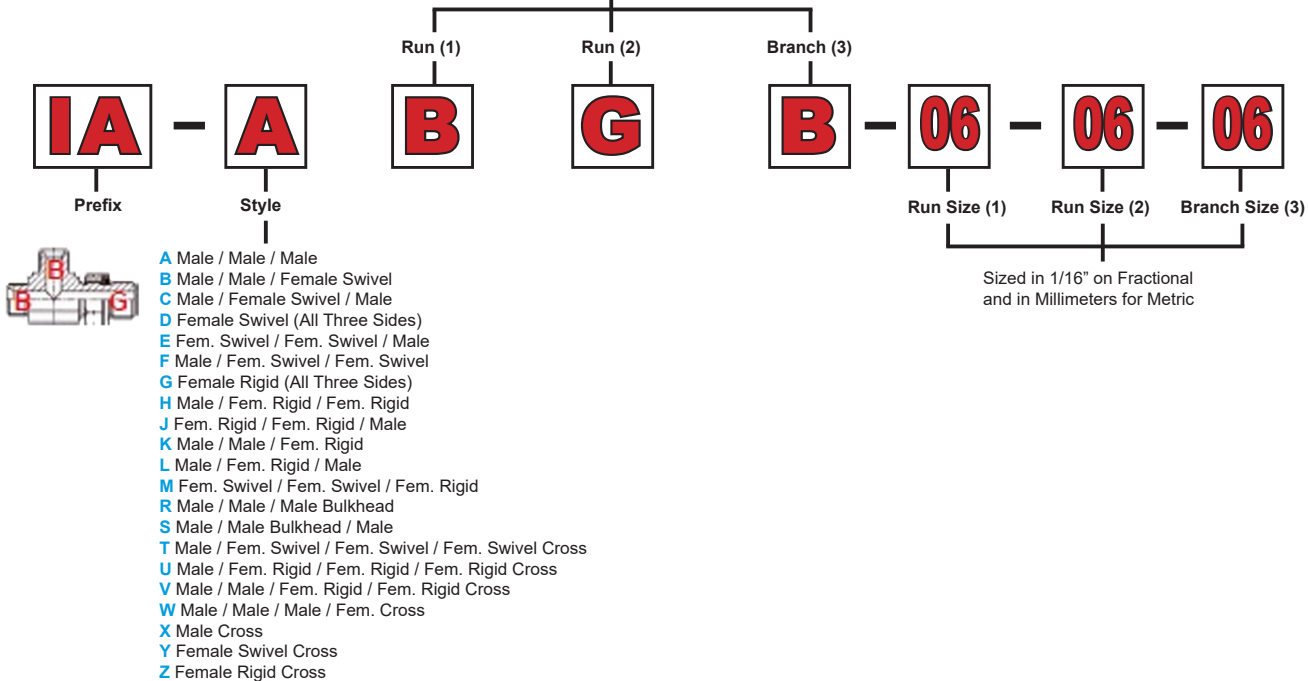
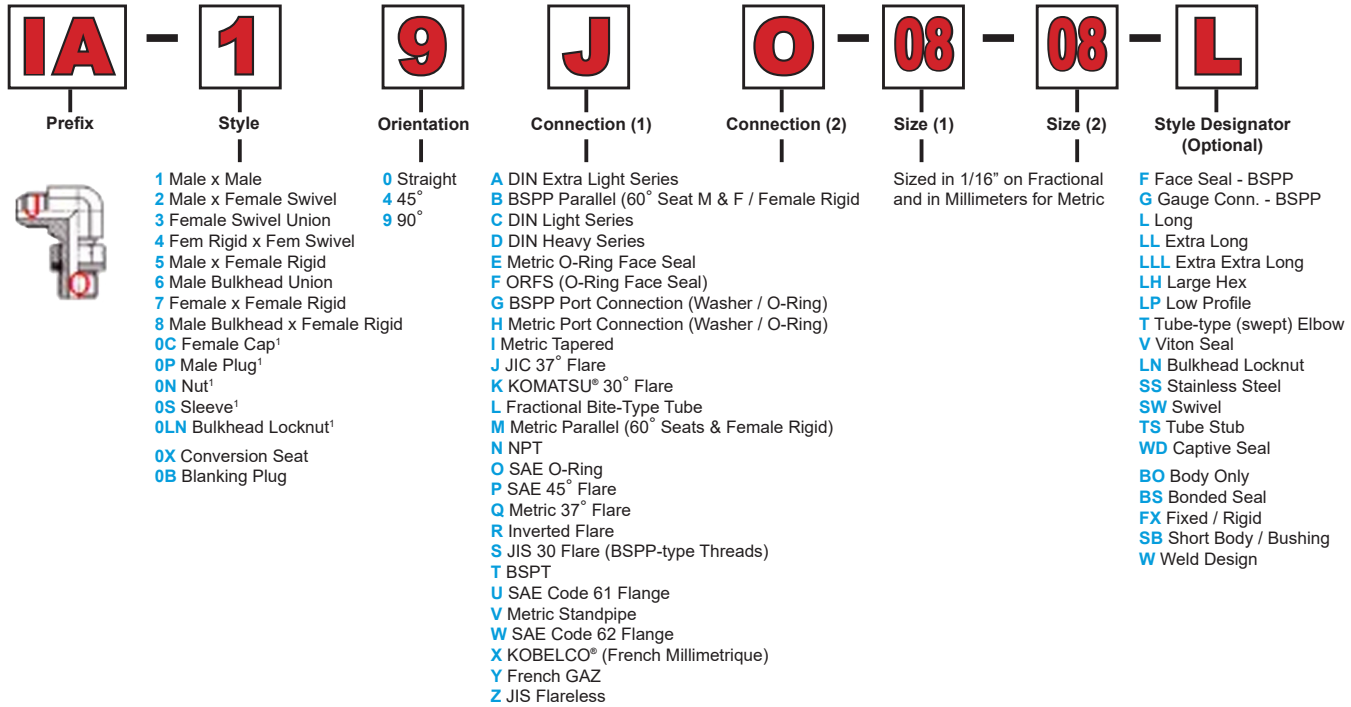

*All DIN Compression part numbers are called by tube size and not the threads.

WARNING This product can expose you to chemicals, which are known to the State of California to cause cancer or birth defects or other reproductive harm. For more information visit <https://www.p65warnings.ca.gov/>



IA-0PHG-WD

BSPP MALE PORT PLUG WITH CAPTIVE SEAL

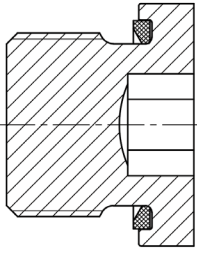
	PART NUMBER	T1
	IA-0PHG-02-WD	1/8 - 28
	IA-0PHG-04-WD	1/4 - 19
	IA-0PHG-06-WD	3/8 - 19
	IA-0PHG-08-WD	1/2 - 14
	IA-0PHG-12-WD	3/4 - 14
	IA-0PHG-16-WD	1 - 11
	IA-0PHG-20-WD	1 1/4 - 11
	IA-0PHG-24-WD	1 1/2 - 11

IA-10BG

60° BSPP MALE x BSPP MALE PORT

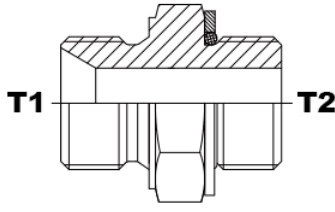
	PART NUMBER	T1	T2
	IA-10BG-02-02	1/8 - 28	1/8 - 28
	IA-10BG-04-04	1/4 - 19	1/4 - 19
	IA-10BG-04-06	1/4 - 19	3/8 - 19
	IA-10BG-06-04	3/8 - 19	1/4 - 19
	IA-10BG-06-06	3/8 - 19	3/8 - 19
	IA-10BG-08-08	1/2 - 14	1/2 - 14
	IA-10BG-08-12	1/2 - 14	3/4 - 14
	IA-10BG-10-08	5/8 - 14	1/2 - 14
	IA-10BG-12-08	3/4 - 14	1/2 - 14
	IA-10BG-12-12	3/4 - 14	3/4 - 14
	IA-10BG-16-08	1 - 11	1/2 - 14
	IA-10BG-16-12	1 - 11	3/4 - 14
	IA-10BG-16-16	1 - 11	1 - 11
	IA-10BG-20-20	1 1/4 - 11	1 1/4 - 11
	IA-10BG-24-24	1 1/2 - 11	1 1/2 - 11

IA-14BG

60° BSPP MALE x 45° BSPP MALE ADJ.

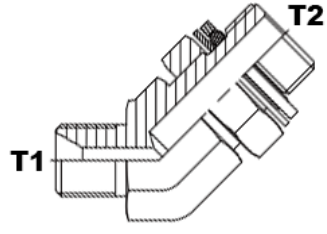
	PART NUMBER	T1	T2
	IA-14BG-04-04	1/4 - 19	1/4 - 19
	IA-14BG-04-06	1/4 - 19	3/8 - 19
	IA-14BG-06-06	3/8 - 19	3/8 - 19
	IA-14BG-06-08	3/8 - 19	1/2 - 14
	IA-14BG-08-08	1/2 - 14	1/2 - 14
	IA-14BG-12-12	3/4 - 14	3/4 - 14
	IA-14BG-16-16	1 - 11	1 - 11
	IA-14BG-20-20	1 1/4 - 11	1 1/4 - 11

WARNING This product can expose you to chemicals, which are known to the State of California to cause cancer or birth defects or other reproductive harm. For more information visit <https://www.p65warnings.ca.gov/>

IA-0CB

BSPP FEMALE CAP 60° CONE SEAT

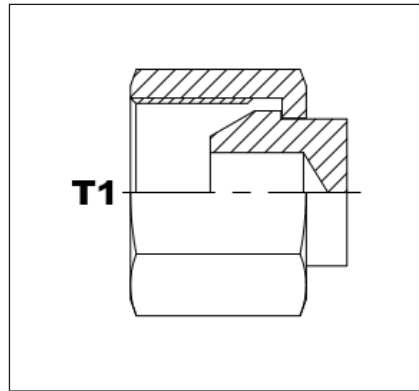

PART NUMBER	T1
IA-0CB-02	1/8 - 28
IA-0CB-04	1/4 - 19
IA-0CB-06	3/8 - 19
IA-0CB-08	1/2 - 14
IA-0CB-10	5/8 - 14
IA-0CB-12	3/4 - 14
IA-0CB-16	1 - 11
IA-0CB-20	1 1/4 - 11
IA-0CB-24	1 1/2 - 11
IA-0CB-32	2 - 11

IA-0PB

BSPP MALE PLUG 60° CONE SEAT

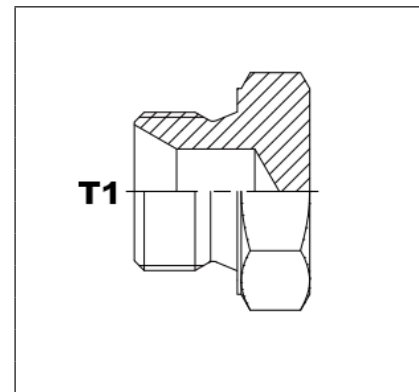

PART NUMBER	T1
IA-0PB-02	1/8 - 28
IA-0PB-04	1/4 - 19
IA-0PB-06	3/8 - 19
IA-0PB-08	1/2 - 14
IA-0PB-10	5/8 - 14
IA-0PB-12	3/4 - 14
IA-0PB-16	1 - 11
IA-0PB-20	1 1/4 - 11
IA-0PB-24	1 1/2 - 11
IA-0PB-32	2 - 11
IA-0PB-40	2 1/2 - 11

IA-0PB-WD BSPP MALE PLUG DUAL PURPOSE (CAPTIVE SEAL)

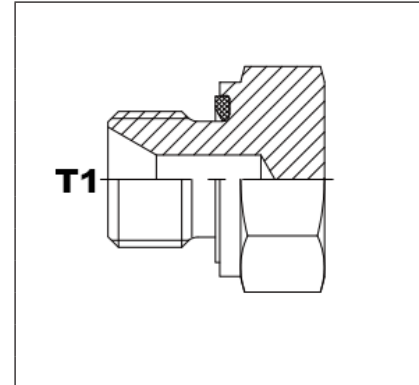

PART NUMBER	T1
IA-0PB-02-WD	1/8 - 28
IA-0PB-04-WD	1/4 - 19
IA-0PB-06-WD	3/8 - 19
IA-0PB-08-WD	1/2 - 14
IA-0PB-12-WD	3/4 - 14
IA-0PB-16-WD	1 - 11
IA-0PB-20-WD	1 1/4 - 11
IA-0PB-24-WD	1 1/2 - 11

WARNING This product can expose you to chemicals, which are known to the State of California to cause cancer or birth defects or other reproductive harm. For more information visit <https://www.p65warnings.ca.gov/>



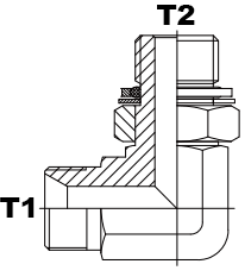

IA-19BG 60° BSPP MALE x 90° BSPP MALE ADJ.

	PART NUMBER	T1	T2
	IA-19BG-04-04	1/4 - 19	1/4 - 19
IA-19BG-04-06	1/4 - 19	3/8 - 19	
IA-19BG-06-04	3/8 - 19	1/4 - 19	
IA-19BG-06-06	3/8 - 19	3/8 - 19	
IA-19BG-06-08	3/8 - 19	1/2 - 14	
IA-19BG-08-06	1/2 - 14	3/8 - 19	
IA-19BG-08-08	1/2 - 14	1/2 - 14	
IA-19BG-08-12	1/2 - 14	3/4 - 14	
IA-19BG-12-08	3/4 - 14	1/2 - 14	
IA-19BG-12-12	3/4 - 14	3/4 - 14	
IA-19BG-12-16	3/4 - 14	1 - 11	
IA-19BG-16-16	1 - 11	1 - 11	
IA-19BG-20-20	1 1/4 - 11	1 1/4 - 11	
IA-19BG-24-24	1 1/2 - 11	1 1/2 - 11	

IA-ABBG BSPP MALE 60° x BSPP MALE ADJ. BR. TEE

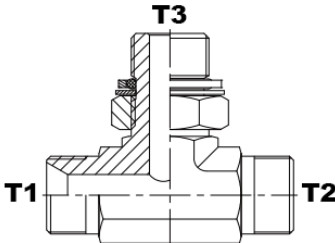
	PART NUMBER	T1	T2	T3
	IA-ABBG-04-04-04	1/4 - 19	1/4 - 19	1/4 - 19
IA-ABBG-06-06-04	3/8 - 19	3/8 - 19	3/8 - 19	
IA-ABBG-06-06-06	3/8 - 19	3/8 - 19	3/8 - 19	
IA-ABBG-08-08-06	1/2 - 14	1/2 - 14	3/8 - 19	
IA-ABBG-08-08-08	1/2 - 14	1/2 - 14	1/2 - 14	
IA-ABBG-12-12-12	3/4 - 14	3/4 - 14	3/4 - 14	
IA-ABBG-16-16-16	1 - 11	1 - 11	1 - 11	

IA-ABGB 60° BSPP MALE x BSPP MALE ADJ. RUN TEE

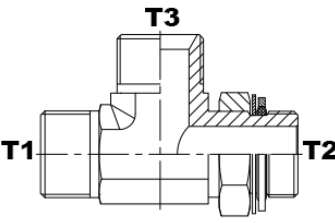
	PART NUMBER	T1	T2	T3
	IA-ABGB-04-04-04	1/4 - 19	1/4 - 19	1/4 - 19
IA-ABGB-06-06-06	3/8 - 19	3/8 - 19	3/8 - 19	
IA-ABGB-08-08-08	1/2 - 14	1/2 - 14	1/2 - 14	
IA-ABGB-12-12-12	3/4 - 14	3/4 - 14	3/4 - 14	
IA-ABGB-16-16-16	1 - 11	1 - 11	1 - 11	

WARNING This product can expose you to chemicals, which are known to the State of California to cause cancer or birth defects or other reproductive harm. For more information visit <https://www.p65warnings.ca.gov/>

IA-20GB

BSPP MALE PORT x BSPP FEMALE SWIVEL

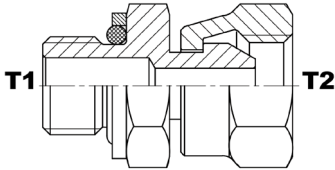
	PART NUMBER	T1	T2
	IA-20GB-02-02	1/8 - 28	1/8 - 28
IA-20GB-04-02	1/4 - 19	1/8 - 28	
IA-20GB-04-04	1/4 - 19	1/4 - 19	
IA-20GB-04-06	1/4 - 19	3/8 - 19	
IA-20GB-06-04	3/8 - 19	1/4 - 19	
IA-20GB-06-06	3/8 - 19	3/8 - 19	
IA-20GB-06-08	3/8 - 19	1/2 - 14	
IA-20GB-08-06	1/2 - 14	3/8 - 19	
IA-20GB-08-08	1/2 - 14	1/2 - 14	
IA-20GB-08-10	1/2 - 14	5/8 - 14	
IA-20GB-08-12	1/2 - 14	3/4 - 14	
IA-20GB-12-08	3/4 - 14	1/2 - 14	
IA-20GB-12-12	3/4 - 14	3/4 - 14	
IA-20GB-12-16	3/4 - 14	1 - 11	
IA-20GB-16-12	1 - 11	3/4 - 14	
IA-20GB-16-16	1 - 11	1 - 11	
IA-20GB-20-16	1 1/4 - 11	1 - 11	
IA-20GB-20-20	1 1/4 - 11	1 1/4 - 11	
IA-20GB-24-24	1 1/2 - 11	1 1/2 - 11	

IA-24GB

45° BSPP MALE ADJ. x BSPP FEMALE SWIVEL

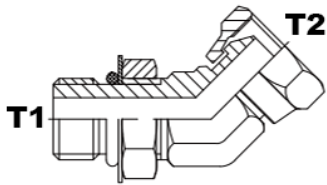
	PART NUMBER	T1	T2
	IA-24GB-04-04	1/4 - 19	1/4 - 19
IA-24GB-06-06	3/8 - 19	3/8 - 19	
IA-24GB-08-08	1/2 - 14	1/2 - 14	
IA-24GB-12-12	3/4 - 14	3/4 - 14	

IA-29GB

90° BSPP MALE ADJ. x BSPP FEMALE SWIVEL

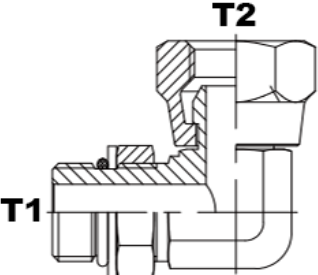
	PART NUMBER	T1	T2
	IA-29GB-04-04	1/4 - 19	1/4 - 19
IA-29GB-06-06	3/8 - 19	3/8 - 19	
IA-29GB-08-08	1/2 - 14	1/2 - 14	
IA-29GB-12-12	3/4 - 14	3/4 - 14	

WARNING This product can expose you to chemicals, which are known to the State of California to cause cancer or birth defects or other reproductive harm. For more information visit <https://www.p65warnings.ca.gov/>



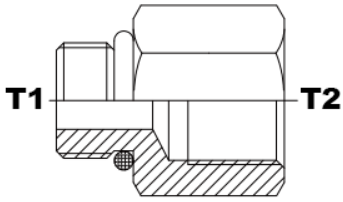

IA-50GB BSPP PORT MALE x FEMALE RIGID

	PART NUMBER	T1	T2
	IA-50GB-04-04	1/4 - 19	1/4 - 19
IA-50GB-04-06	1/4 - 19	3/8 - 19	
IA-50GB-04-08	1/4 - 19	1/2 - 14	
IA-50GB-06-04	3/8 - 19	1/4 - 19	
IA-50GB-06-06	3/8 - 19	3/8 - 19	
IA-50GB-06-08	3/8 - 19	1/2 - 14	
IA-50GB-08-06	1/2 - 14	3/8 - 19	
IA-50GB-08-08	1/2 - 14	1/2 - 14	
IA-50GB-08-12	1/2 - 14	3/4 - 14	
IA-50GB-12-08	3/4 - 14	1/2 - 14	
IA-50GB-12-12	3/4 - 14	3/4 - 14	
IA-50GB-12-16	3/4 - 14	1 - 11	
IA-50GB-16-12	1 - 11	3/4 - 14	
IA-50GB-16-16	1 - 11	1 - 11	
IA-50GB-16-20	1 - 11	1 1/4 - 11	
IA-50GB-20-24	1 1/4 - 11	1 1/2 - 11	

IA-59GB BSPP PORT ADJ. MALE x 90° FEMALE RIGID

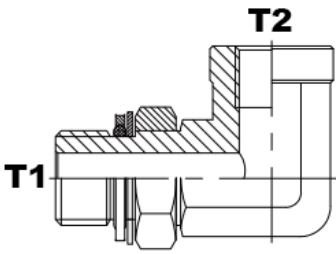
	PART NUMBER	T1	T2
	IA-59GB-02-02	1/8 - 28	1/8 - 28
IA-59GB-04-04	1/4 - 19	1/4 - 19	
IA-59GB-04-06	1/4 - 19	3/8 - 19	
IA-59GB-06-06	3/8 - 19	3/8 - 19	
IA-59GB-06-08	3/8 - 19	1/2 - 14	
IA-59GB-08-08	1/2 - 14	1/2 - 14	
IA-59GB-12-08	3/4 - 14	1/2 - 14	
IA-59GB-12-12	3/4 - 14	3/4 - 14	
IA-59GB-12-16	3/4 - 14	1 - 11	
IA-59GB-16-16	1 - 11	1 - 11	
IA-59GB-20-20	1 1/4 - 11	1 1/4 - 11	

⚠ WARNING This product can expose you to chemicals, which are known to the State of California to cause cancer or birth defects or other reproductive harm. For more information visit <https://www.p65warnings.ca.gov/>

IA-10BT

BSPP MALE x BSPT MALE

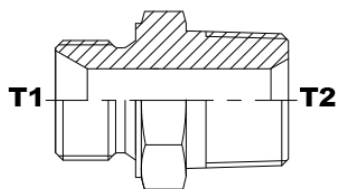

PART NUMBER	T1	T2
IA-10BT-02-02	1/8 - 28	1/8 - 28
IA-10BT-02-04	1/8 - 28	1/4 - 19
IA-10BT-02-06	1/8 - 28	3/8 - 19
IA-10BT-04-02	1/4 - 19	1/8 - 28
IA-10BT-04-04	1/4 - 19	1/4 - 19
IA-10BT-04-06	1/4 - 19	3/8 - 19
IA-10BT-04-08	1/4 - 19	1/2 - 14
IA-10BT-06-02	3/8 - 19	1/8 - 28
IA-10BT-06-04	3/8 - 19	1/4 - 19
IA-10BT-06-06	3/8 - 19	3/8 - 19
IA-10BT-06-08	3/8 - 19	1/2 - 14
IA-10BT-06-10	3/8 - 19	5/8 - 14
IA-10BT-06-12	3/8 - 19	3/4 - 14
IA-10BT-08-04	1/2 - 14	1/4 - 19
IA-10BT-08-06	1/2 - 14	3/8 - 19
IA-10BT-08-08	1/2 - 14	1/2 - 14
IA-10BT-08-10	1/2 - 14	5/8 - 14
IA-10BT-08-12	1/2 - 14	3/4 - 14
IA-10BT-08-16	1/2 - 14	1 - 11
IA-10BT-10-06	5/8 - 14	3/8 - 19
IA-10BT-10-08	5/8 - 14	1/2 - 14
IA-10BT-10-10	5/8 - 14	5/8 - 14
IA-10BT-10-12	5/8 - 14	3/4 - 14
IA-10BT-12-04	3/4 - 14	1/4 - 19
IA-10BT-12-06	3/4 - 14	3/8 - 19
IA-10BT-12-08	3/4 - 14	1/2 - 14
IA-10BT-12-12	3/4 - 14	3/4 - 14
IA-10BT-12-16	3/4 - 14	1 - 11
IA-10BT-12-20	3/4 - 14	1 1/4 - 11
IA-10BT-16-08	1 - 11	1/2 - 14
IA-10BT-16-12	1 - 11	3/4 - 14
IA-10BT-16-16	1 - 11	1 - 11
IA-10BT-16-20	1 - 11	1 1/4 - 11
IA-10BT-16-24	1 - 11	1 1/2 - 11
IA-10BT-16-32	1 - 11	2 - 11
IA-10BT-20-12	1 1/4 - 11	3/4 - 14
IA-10BT-20-16	1 1/4 - 11	1 - 11
IA-10BT-20-20	1 1/4 - 11	1 1/4 - 11
IA-10BT-20-24	1 1/4 - 11	1 1/2 - 11
IA-10BT-20-32	1 1/4 - 11	2 - 11
IA-10BT-24-16	1 1/2 - 11	1 - 11
IA-10BT-24-20	1 1/2 - 11	1 1/4 - 11
IA-10BT-24-24	1 1/2 - 11	1 1/2 - 11
IA-10BT-24-32	1 1/2 - 11	2 - 11
IA-10BT-32-24	2 - 11	1 1/2 - 11
IA-10BT-32-32	2 - 11	2 - 11
IA-10BT-40-40	2 1/2 - 11	2 1/2 - 11
IA-10BT-48-48	3 - 11	3 - 11

BSPP 60° • BSPP PORT • BSPT



WARNING This product can expose you to chemicals, which are known to the State of California to cause cancer or birth defects or other reproductive harm. For more information visit <https://www.p65warnings.ca.gov/>



IA-14BT BSPP MALE x 45° BSPT MALE

	PART NUMBER	T1	T2
	IA-14BT-04-02	1/4 - 19	1/8 - 28
	IA-14BT-04-04	1/4 - 19	1/4 - 19
	IA-14BT-04-06	1/4 - 19	3/8 - 19
	IA-14BT-06-04	3/8 - 19	1/4 - 19
	IA-14BT-06-06	3/8 - 19	3/8 - 19
	IA-14BT-08-06	1/2 - 14	3/8 - 19
	IA-14BT-08-08	1/2 - 14	1/2 - 14
	IA-14BT-12-12	3/4 - 14	3/4 - 14
	IA-14BT-16-16	1 - 11	1 - 11

IA-19BT BSPP MALE x 90° BSPT MALE

	PART NUMBER	T1	T2
	IA-19BT-02-02	1/8 - 28	1/8 - 28
	IA-19BT-02-04	1/8 - 28	1/4 - 19
	IA-19BT-04-02	1/4 - 19	1/8 - 28
	IA-19BT-04-04	1/4 - 19	1/4 - 19
	IA-19BT-06-04	3/8 - 19	1/4 - 19
	IA-19BT-06-06	3/8 - 19	3/8 - 19
	IA-19BT-08-06	1/2 - 14	3/8 - 19
	IA-19BT-08-08	1/2 - 14	1/2 - 14
	IA-19BT-12-12	3/4 - 14	3/4 - 14
	IA-19BT-16-16	1 - 11	1 - 11

IA-ABBT BSPP MALE x BSPT MALE BR. TEE

	PART NUMBER	T1	T2	T3
	IA-ABBT-02-02-02	1/8 - 28	1/8 - 28	1/8 - 28
	IA-ABBT-04-04-04	1/4 - 19	1/4 - 19	1/4 - 19
	IA-ABBT-06-06-06	3/8 - 19	3/8 - 19	3/8 - 19
	IA-ABBT-08-08-08	1/2 - 14	1/2 - 14	1/2 - 14
	IA-ABBT-12-12-12	3/4 - 14	3/4 - 14	3/4 - 14
	IA-ABBT-16-16-16	1 - 11	1 - 11	1 - 11

IA-ABTB BSPP MALE x BSPT MALE RUN TEE

	PART NUMBER	T1	T2	T3
	IA-ABTB-02-02-02	1/8 - 28	1/8 - 28	1/8 - 28
	IA-ABTB-04-04-04	1/4 - 19	1/4 - 19	1/4 - 19
	IA-ABTB-06-06-06	3/8 - 19	3/8 - 19	3/8 - 19
	IA-ABTB-08-08-08	1/2 - 14	1/2 - 14	1/2 - 14
	IA-ABTB-12-12-12	3/4 - 14	3/4 - 14	3/4 - 14
	IA-ABTB-16-16-16	1 - 11	1 - 11	1 - 11

WARNING This product can expose you to chemicals, which are known to the State of California to cause cancer or birth defects or other reproductive harm. For more information visit <https://www.p65warnings.ca.gov/>



IA-20TB BSPT MALE x BSPP FEMALE SWIVEL

	PART NUMBER	T1	T2
	IA-20TB-02-02	1/8 - 28	1/8 - 28
	IA-20TB-04-04	1/4 - 19	1/4 - 19
	IA-20TB-06-06	3/8 - 19	3/8 - 19
	IA-20TB-08-08	1/2 - 14	1/2 - 14
	IA-20TB-12-12	3/4 - 14	3/4 - 14
	IA-20TB-16-12	1 - 11	3/4 - 14
	IA-20TB-16-16	1 - 11	1 - 11

IA-24TB BSPT MALE x 45° BSPP FEMALE SWIVEL

	PART NUMBER	T1	T2
	IA-24TB-02-02	1/8 - 28	1/8 - 28
	IA-24TB-04-04	1/4 - 19	1/4 - 19
	IA-24TB-06-06	3/8 - 19	3/8 - 19
	IA-24TB-08-08	1/2 - 14	1/2 - 14
	IA-24TB-12-12	3/4 - 14	3/4 - 14
	IA-24TB-16-16	1 - 11	1 - 11

IA-29TB 90° BSPT MALE x BSPP FEMALE SWIVEL

	PART NUMBER	T1	T2
	IA-29TB-02-02	1/8 - 28	1/8 - 28
	IA-29TB-04-04	1/4 - 19	1/4 - 19
	IA-29TB-06-06	3/8 - 19	3/8 - 19
	IA-29TB-08-08	1/2 - 14	1/2 - 14
	IA-29TB-12-12	3/4 - 14	3/4 - 14
	IA-29TB-16-16	1 - 11	1 - 11

IA-50BT 60° BSPP MALE x BSPT FEMALE RIGID

	PART NUMBER	T1	T2
	IA-50BT-04-02	1/4 - 19	1/8 - 28
	IA-50BT-04-04	1/4 - 19	1/4 - 19
	IA-50BT-06-04	3/8 - 19	1/4 - 19
	IA-50BT-06-06	3/8 - 19	3/8 - 19
	IA-50BT-08-08	1/2 - 14	1/2 - 14
	IA-50BT-12-12	3/4 - 14	3/4 - 14

WARNING This product can expose you to chemicals, which are known to the State of California to cause cancer or birth defects or other reproductive harm. For more information visit <https://www.p65warnings.ca.gov/>

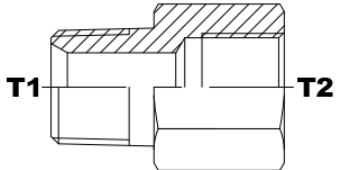

IA-50TB BSPT MALE x BSPP FEMALE RIGID

	PART NUMBER	T1	T2
	IA-50TB-02-04	1/8 - 28	1/4 - 19
IA-50TB-04-04	1/4 - 19	1/4 - 19	
IA-50TB-04-06	1/4 - 19	3/8 - 19	
IA-50TB-06-02	3/8 - 19	1/8 - 28	
IA-50TB-06-04	3/8 - 19	1/4 - 19	
IA-50TB-06-06	3/8 - 19	3/8 - 19	
IA-50TB-06-08	3/8 - 19	1/2 - 14	
IA-50TB-08-04	1/2 - 14	1/4 - 19	
IA-50TB-08-08	1/2 - 14	1/2 - 14	
IA-50TB-08-12	1/2 - 14	3/4 - 14	
IA-50TB-12-06	3/4 - 14	3/8 - 19	
IA-50TB-12-12	3/4 - 14	3/4 - 14	
IA-50TB-12-16	3/4 - 14	1 - 11	
IA-50TB-16-08	1 - 11	1/2 - 14	
IA-50TB-16-12	1 - 11	3/4 - 14	
IA-50TB-16-16	1 - 11	1 - 11	

IA-54TB BSPT MALE x 45° BSPP FEMALE RIGID

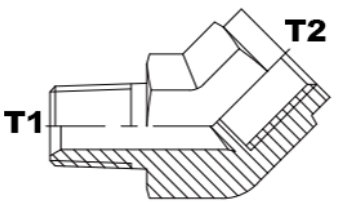
	PART NUMBER	T1	T2
	IA-54TB-02-02	1/8 - 28	1/8 - 28
IA-54TB-04-04	1/4 - 19	1/4 - 19	
IA-54TB-06-06	3/8 - 19	3/8 - 19	
IA-54TB-08-08	1/2 - 14	1/2 - 14	
IA-54TB-12-12	3/4 - 14	3/4 - 14	
IA-54TB-16-16	1 - 11	1 - 11	

IA-59TB BSPT MALE x 90° BSPP FEMALE RIGID

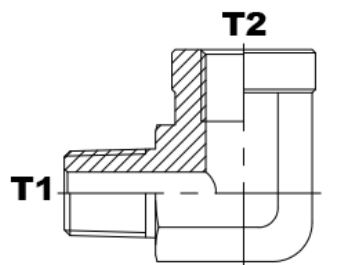
	PART NUMBER	T1	T2
	IA-59TB-02-02	1/8 - 28	1/8 - 28
IA-59TB-04-04	1/4 - 19	1/4 - 19	
IA-59TB-06-06	3/8 - 19	3/8 - 19	
IA-59TB-08-08	1/2 - 14	1/2 - 14	
IA-59TB-12-12	3/4 - 14	3/4 - 14	
IA-59TB-16-16	1 - 11	1 - 11	

⚠ WARNING This product can expose you to chemicals, which are known to the State of California to cause cancer or birth defects or other reproductive harm. For more information visit <https://www.p65warnings.ca.gov/>

IA-0PT

BSPT MALE PLUG

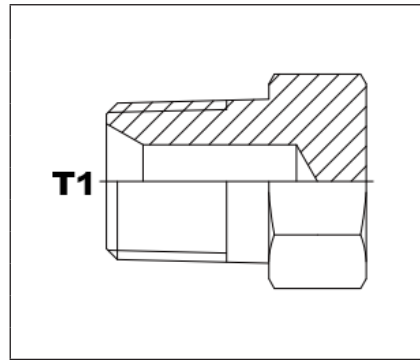

PART NUMBER	T1
IA-0PT-02	1/8 - 28
IA-0PT-04	1/4 - 19
IA-0PT-06	3/8 - 19
IA-0PT-08	1/2 - 14
IA-0PT-10	5/8 - 14
IA-0PT-12	3/4 - 14
IA-0PT-16	1 - 11
IA-0PT-20	1 1/4 - 11
IA-0PT-24	1 1/2 - 11
IA-0PT-32	2 - 11

IA-0PHT

BSPT MALE PLUG ALLEN-TYPE

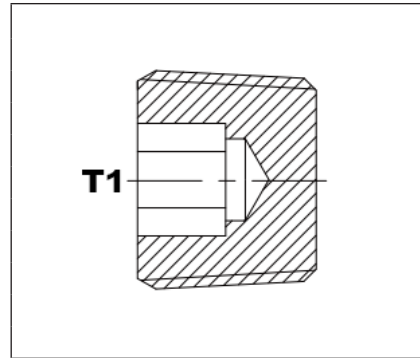

PART NUMBER	T1
IA-0PHT-02	1/8 - 28
IA-0PHT-04	1/4 - 19
IA-0PHT-06	3/8 - 19
IA-0PHT-08	1/2 - 14
IA-0PHT-12	3/4 - 14
IA-0PHT-16	1 - 11
IA-0PHT-20	1 1/4 - 11

IA-10TT

BSPT MALE NIPPLE

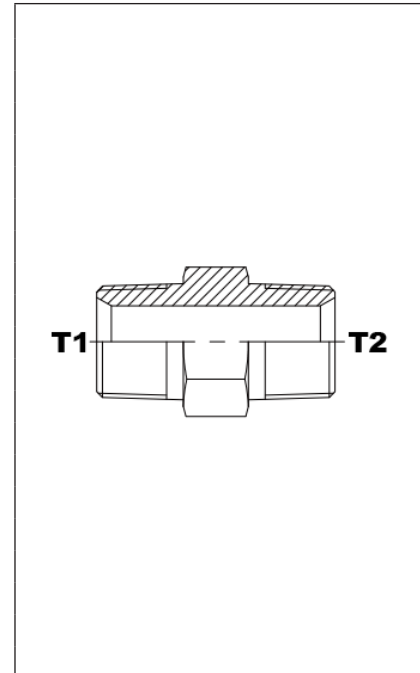

PART NUMBER	T1	T2
IA-10TT-02-02	1/8 - 28	1/8 - 28
IA-10TT-04-02	1/4 - 19	1/8 - 28
IA-10TT-04-04	1/4 - 19	1/4 - 19
IA-10TT-06-02	3/8 - 19	1/8 - 28
IA-10TT-06-04	3/8 - 19	1/4 - 19
IA-10TT-06-06	3/8 - 19	3/8 - 19
IA-10TT-08-04	1/2 - 14	1/4 - 19
IA-10TT-08-06	1/2 - 14	3/8 - 19
IA-10TT-08-08	1/2 - 14	1/2 - 14
IA-10TT-10-10	5/8 - 14	5/8 - 14
IA-10TT-12-08	3/4 - 14	1/2 - 14
IA-10TT-12-12	3/4 - 14	3/4 - 14
IA-10TT-16-08	1 - 11	1/2 - 14
IA-10TT-16-12	1 - 11	3/4 - 14
IA-10TT-16-16	1 - 11	1 - 11
IA-10TT-20-16	1 1/4 - 11	1 - 11
IA-10TT-20-20	1 1/4 - 11	1 1/4 - 11
IA-10TT-24-24	1 1/2 - 11	1 1/2 - 11
IA-10TT-32-32	2 - 11	2 - 11
IA-10TT-40-40	2 1/2 - 11	2 1/2 - 11

WARNING This product can expose you to chemicals, which are known to the State of California to cause cancer or birth defects or other reproductive harm. For more information visit <https://www.p65warnings.ca.gov/>



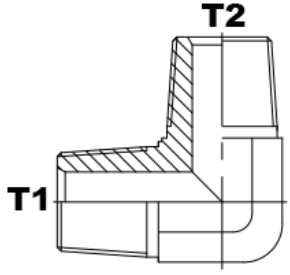

IA-19TT 90° BSPT MALE UNION

	PART NUMBER	T1	T2
	IA-19TT-02-02	1/8 - 28	1/8 - 28
IA-19TT-04-02	1/4 - 19	1/8 - 28	
IA-19TT-04-04	1/4 - 19	1/4 - 19	
IA-19TT-06-02	3/8 - 19	1/8 - 28	
IA-19TT-06-04	3/8 - 19	1/4 - 19	
IA-19TT-06-06	3/8 - 19	3/8 - 19	
IA-19TT-08-02	1/2 - 14	1/8 - 28	
IA-19TT-08-04	1/2 - 14	1/4 - 19	
IA-19TT-08-06	1/2 - 14	3/8 - 19	
IA-19TT-08-08	1/2 - 14	1/2 - 14	
IA-19TT-12-08	3/4 - 14	1/2 - 14	
IA-19TT-12-12	3/4 - 14	3/4 - 14	
IA-19TT-16-12	1 - 11	3/4 - 14	
IA-19TT-16-16	1 - 11	1 - 11	
IA-19TT-20-16	1 1/4 - 11	1 - 11	
IA-19TT-20-20	1 1/4 - 11	1 1/4 - 11	
IA-19TT-24-24	1 1/2 - 11	1 1/2 - 11	
IA-19TT-32-32	2 - 11	2 - 11	

IA-ATTT BSPT MALE TEE

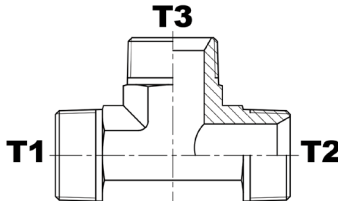
	PART NUMBER	T1	T2	T3
	IA-ATTT-02-02-02	1/8 - 28	1/8 - 28	1/8 - 28
IA-ATTT-04-04-04	1/4 - 19	1/4 - 19	1/4 - 19	1/4 - 19
IA-ATTT-06-06-06	3/8 - 19	3/8 - 19	3/8 - 19	3/8 - 19
IA-ATTT-08-08-08	1/2 - 14	1/2 - 14	1/2 - 14	1/2 - 14
IA-ATTT-12-12-12	3/4 - 14	3/4 - 14	3/4 - 14	3/4 - 14
IA-ATTT-16-16-16	1 - 11	1 - 11	1 - 11	1 - 11
IA-ATTT-20-20-20	1 1/4 - 11	1 1/4 - 11	1 1/4 - 11	1 1/4 - 11
IA-ATTT-24-24-24	1 1/2 - 11	1 1/2 - 11	1 1/2 - 11	1 1/2 - 11
IA-ATTT-32-32-32	2 - 11	2 - 11	2 - 11	2 - 11

IA-50TT BSPT MALE x FEMALE RIGID

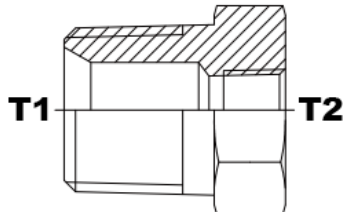
	PART NUMBER	T1	T2
	IA-50TT-02-04	1/8 - 28	1/4 - 19
IA-50TT-04-02	1/4 - 19	1/8 - 28	
IA-50TT-04-04	1/4 - 19	1/4 - 19	
IA-50TT-06-02	3/8 - 19	1/8 - 28	
IA-50TT-06-04	3/8 - 19	1/4 - 19	
IA-50TT-06-06	3/8 - 19	3/8 - 19	
IA-50TT-08-04	1/2 - 14	1/4 - 19	
IA-50TT-08-06	1/2 - 14	3/8 - 19	
IA-50TT-08-08	1/2 - 14	1/2 - 14	
IA-50TT-12-06	3/4 - 14	3/8 - 19	
IA-50TT-12-08	3/4 - 14	1/2 - 14	
IA-50TT-12-12	3/4 - 14	3/4 - 14	
IA-50TT-16-08	1 - 11	1/2 - 14	
IA-50TT-16-12	1 - 11	3/4 - 14	
IA-50TT-16-16	1 - 11	1 - 11	

WARNING This product can expose you to chemicals, which are known to the State of California to cause cancer or birth defects or other reproductive harm. For more information visit <https://www.p65warnings.ca.gov/>

IA-59TT

BSPT MALE x 90° FEMALE RIGID

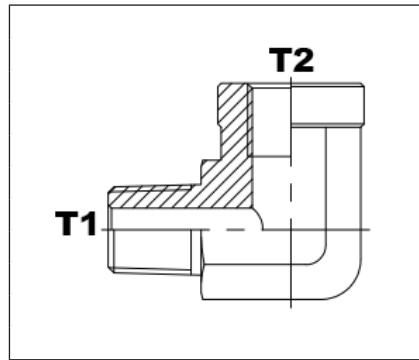

PART NUMBER	T1	T2
IA-59TT-02-02	1/8 - 28	1/8 - 28
IA-59TT-04-04	1/4 - 19	1/4 - 19
IA-59TT-06-06	3/8 - 19	3/8 - 19
IA-59TT-08-08	1/2 - 14	1/2 - 14
IA-59TT-12-12	3/4 - 14	3/4 - 14
IA-59TT-16-16	1 - 11	1 - 11
IA-59TT-20-20	1 1/4 - 11	1 1/4 - 11
IA-59TT-24-24	1 1/2 - 11	1 1/2 - 11

IA-70TT

BSPT FEMALE COUPLING

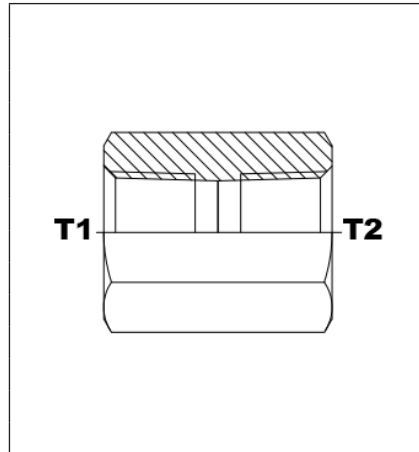

PART NUMBER	T1	T2
IA-70TT-02-02	1/8 - 28	1/8 - 28
IA-70TT-04-02	1/4 - 19	1/8 - 28
IA-70TT-04-04	1/4 - 19	1/4 - 19
IA-70TT-06-04	3/8 - 19	1/4 - 19
IA-70TT-06-06	3/8 - 19	3/8 - 19
IA-70TT-08-06	1/2 - 14	3/8 - 19
IA-70TT-08-08	1/2 - 14	1/2 - 14
IA-70TT-12-12	3/4 - 14	3/4 - 14
IA-70TT-16-16	1 - 11	1 - 11
IA-70TT-20-16	1 1/4 - 11	1 - 11
IA-70TT-20-20	1 1/4 - 11	1 1/4 - 11
IA-70TT-24-24	1 1/2 - 11	1 1/2 - 11
IA-70TT-32-32	2 - 11	2 - 11



WARNING This product can expose you to chemicals, which are known to the State of California to cause cancer or birth defects or other reproductive harm. For more information visit <https://www.p65warnings.ca.gov/>



IA-30FB

ORFS x BSPP FEMALE SWIVEL UNION

	PART NUMBER	T1	T2
	IA-30FB-04-04	9/16 - 18	1/4 - 19
	IA-30FB-06-06	11/16 - 16	3/8 - 19
	IA-30FB-08-08	13/16 - 16	1/2 - 14
	IA-30FB-10-12	1 - 14	3/4 - 14
	IA-30FB-12-12	1 3/16 - 12	3/4 - 14
	IA-30FB-16-16	1 7/16 - 12	1 - 11

*All "B" Male Threads have 60° Seat.

*All "G" Threads come with O-Ring / Washer combination for external port sealing.

IA-10BM

60° BSPP MALE x METRIC MALE

	PART NUMBER	T1	T2
	IA-10BM-02-10	1/8 - 28	10 X 1.0
	IA-10BM-02-12	1/8 - 28	12 X 1.5
	IA-10BM-02-14	1/8 - 28	14 X 1.5
	IA-10BM-04-10	1/4 - 19	10 X 1.0
	IA-10BM-04-10A	1/4 - 19	10 X 1.25
	IA-10BM-04-12	1/4 - 19	12 X 1.5
	IA-10BM-04-12A	1/4 - 19	12 X 1.0
	IA-10BM-04-12B	1/4 - 19	12 X 1.25
	IA-10BM-04-14	1/4 - 19	14 X 1.5
	IA-10BM-04-16	1/4 - 19	16 X 1.5
	IA-10BM-04-18	1/4 - 19	18 X 1.5
	IA-10BM-06-12	3/8 - 19	12 X 1.5
	IA-10BM-06-14	3/8 - 19	14 X 1.5
	IA-10BM-06-16	3/8 - 19	16 X 1.5
	IA-10BM-06-18	3/8 - 19	18 X 1.5
	IA-10BM-06-20	3/8 - 19	20 X 1.5
	IA-10BM-06-22	3/8 - 19	22 X 1.5
	IA-10BM-08-12	1/2 - 14	12 X 1.5
	IA-10BM-08-14	1/2 - 14	14 X 1.5
	IA-10BM-08-16	1/2 - 14	16 X 1.5
	IA-10BM-08-18	1/2 - 14	18 X 1.5
	IA-10BM-08-20	1/2 - 14	20 X 1.5
	IA-10BM-08-22	1/2 - 14	22 X 1.5
	IA-10BM-08-24	1/2 - 14	24 X 1.5
	IA-10BM-08-26	1/2 - 14	26 X 1.5
	IA-10BM-10-22	5/8 - 14	22 X 1.5
	IA-10BM-10-26	5/8 - 14	26 X 1.5
	IA-10BM-12-18	3/4 - 14	18 X 1.5
	IA-10BM-12-20	3/4 - 14	20 X 1.5
	IA-10BM-12-22	3/4 - 14	22 X 1.5
	IA-10BM-12-24	3/4 - 14	24 X 1.5
	IA-10BM-12-26	3/4 - 14	26 X 1.5
	IA-10BM-12-30	3/4 - 14	30 X 2.0
	IA-10BM-12-30D	3/4 - 14	30 X 1.5
	IA-10BM-16-26	1 - 11	26 X 1.5
	IA-10BM-16-30D	1 - 11	30 X 1.5
	IA-10BM-16-33	1 - 11	33 X 2.0
IA-10BM-16-38	1 - 11	38 X 2.0	
IA-10BM-20-38	1 1/4 - 11	38 X 2.0	

*All "B" Male Threads have 60° Seat.

*All "G" Threads come with O-Ring / Washer combination for external port sealing.



WARNING This product can expose you to chemicals, which are known to the State of California to cause cancer or birth defects or other reproductive harm. For more information visit <https://www.p65warnings.ca.gov/>

IA-10BM-WD

60° BSPP MALE x METRIC (CAPTIVE SEAL)

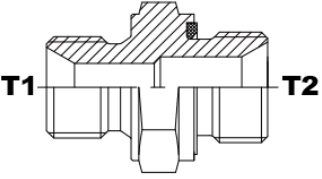
 <p>*Quoted Upon Request</p>	PART NUMBER	T1	T2

*All "B" Male Threads have 60° Seat.

*All "G" Threads come with O-Ring / Washer combination for external port sealing.

IA-20MB

METRIC MALE x BSPP FEMALE SWIVEL

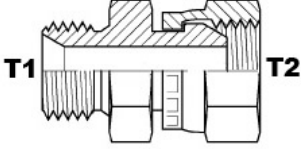
	PART NUMBER	T1	T2
	IA-20MB-12-04	12 X 1.5	1/4 - 19
	IA-20MB-14-04	14 X 1.5	1/4 - 19
	IA-20MB-14-06	14 X 1.5	3/8 - 19
	IA-20MB-14-08	14 X 1.5	1/2 - 14
	IA-20MB-16-04	16 X 1.5	1/4 - 19
	IA-20MB-16-06	16 X 1.5	3/8 - 19
	IA-20MB-16-08	16 X 1.5	1/2 - 14
	IA-20MB-16-12	16 X 1.5	3/4 - 14
	IA-20MB-18-06	18 X 1.5	3/8 - 19
	IA-20MB-18-08	18 X 1.5	1/2 - 14
	IA-20MB-20-06	20 X 1.5	3/8 - 19
	IA-20MB-20-08	20 X 1.5	1/2 - 14
	IA-20MB-20-12	20 X 1.5	3/4 - 14
	IA-20MB-22-06	22 X 1.5	3/8 - 19
	IA-20MB-22-08	22 X 1.5	1/2 - 14
	IA-20MB-22-12	22 X 1.5	3/4 - 14
	IA-20MB-26-06	26 X 1.5	3/8 - 19
	IA-20MB-26-08	26 X 1.5	1/2 - 14
	IA-20MB-26-12	26 X 1.5	3/4 - 14
IA-20MB-30-06	30 X 2.0	3/8 - 19	
IA-20MB-30-08	30 X 2.0	1/2 - 14	
IA-20MB-30D-06	30 X 1.5	3/8 - 19	
IA-20MB-30D-08	30 X 1.5	1/2 - 14	

*All "B" Male Threads have 60° Seat.

*All "G" Threads come with O-Ring / Washer combination for external port sealing.

IA-50BM

BSPP MALE x METRIC FEMALE

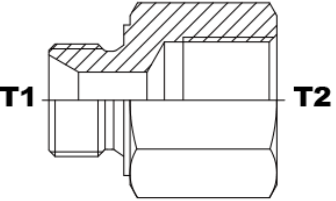
	PART NUMBER	T1	T2
	IA-50BM-06-14	3/8 - 19	14 X 1.5
	IA-50BM-06-18	3/8 - 19	18 X 1.5
	IA-50BM-08-18	1/2 - 14	18 X 1.5
	IA-50BM-08-22	1/2 - 14	22 X 1.5

*All "B" Male Threads have 60° Seat.

*All "G" Threads come with O-Ring / Washer combination for external port sealing.

WARNING This product can expose you to chemicals, which are known to the State of California to cause cancer or birth defects or other reproductive harm. For more information visit <https://www.p65warnings.ca.gov/>



IA-10BH

60° BSPP MALE x METRIC PORT MALE

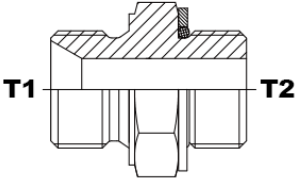
	PART NUMBER	T1	T2
	IA-10BH-02-10	1/8 - 28	10 X 1.0
IA-10BH-02-12	1/8 - 28	12 X 1.5	
IA-10BH-04-12	1/4 - 19	12 X 1.5	
IA-10BH-04-14	1/4 - 19	14 X 1.5	
IA-10BH-04-16	1/4 - 19	16 X 1.5	
IA-10BH-06-14	3/8 - 19	14 X 1.5	
IA-10BH-06-16	3/8 - 19	16 X 1.5	
IA-10BH-06-18	3/8 - 19	18 X 1.5	
IA-10BH-08-18	1/2 - 14	18 X 1.5	
IA-10BH-08-20	1/2 - 14	20 X 1.5	
IA-10BH-08-22	1/2 - 14	22 X 1.5	
IA-10BH-10-22	5/8 - 14	22 X 1.5	
IA-10BH-12-16	3/4 - 14	16 X 1.5	
IA-10BH-12-22	3/4 - 14	22 X 1.5	
IA-10BH-12-27	3/4 - 14	27 X 2.0	
IA-10BH-16-27	1 - 11	27 X 2.0	
IA-10BH-16-33	1 - 11	33 X 2.0	
IA-10BH-20-42	1 1/4 - 11	42 X 2.0	
IA-10BH-24-48	1 1/2 - 11	48 X 2.0	

*All "B" Male Threads have 60° Seat.

*All "G" Threads come with O-Ring / Washer combination for external port sealing.

IA-14BH

60° BSPP MALE x 45° METRIC PORT ADJ. MALE

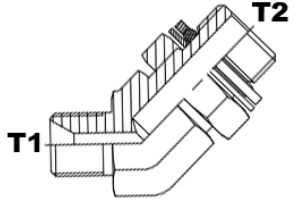
	PART NUMBER	T1	T2
	IA-14BH-02-10	1/8 - 28	10 X 1.0
IA-14BH-02-12	1/8 - 28	12 X 1.5	
IA-14BH-04-12	1/4 - 19	12 X 1.5	
IA-14BH-04-14	1/4 - 19	14 X 1.5	
IA-14BH-04-16	1/4 - 19	16 X 1.5	
IA-14BH-06-14	3/8 - 19	14 X 1.5	
IA-14BH-06-16	3/8 - 19	16 X 1.5	
IA-14BH-06-18	3/8 - 19	18 X 1.5	
IA-14BH-08-18	1/2 - 14	18 X 1.5	
IA-14BH-08-20	1/2 - 14	20 X 1.5	
IA-14BH-08-22	1/2 - 14	22 X 1.5	
IA-14BH-10-22	5/8 - 14	22 X 1.5	
IA-14BH-12-22	3/4 - 14	22 X 1.5	
IA-14BH-12-27	3/4 - 14	27 X 2.0	
IA-14BH-16-27	1 - 11	27 X 2.0	
IA-14BH-16-33	1 - 11	33 X 2.0	
IA-14BH-20-42	1 1/4 - 11	42 X 2.0	
IA-14BH-24-48	1 1/2 - 11	48 X 2.0	

*All "B" Male Threads have 60° Seat.

*All "G" Threads come with O-Ring / Washer combination for external port sealing.



WARNING This product can expose you to chemicals, which are known to the State of California to cause cancer or birth defects or other reproductive harm. For more information visit <https://www.p65warnings.ca.gov/>

IA-19BH

BSPP MALE x 90° METRIC PORT ADJ. MALE

PART NUMBER	T1	T2
	IA-19BH-02-10	1/8 - 28
IA-19BH-02-12	1/8 - 28	12 X 1.5
IA-19BH-04-12	1/4 - 19	12 X 1.5
IA-19BH-04-14	1/4 - 19	14 X 1.5
IA-19BH-04-16	1/4 - 19	16 X 1.5
IA-19BH-06-14	3/8 - 19	14 X 1.5
IA-19BH-06-16	3/8 - 19	16 X 1.5
IA-19BH-06-18	3/8 - 19	18 X 1.5
IA-19BH-08-18	1/2 - 14	18 X 1.5
IA-19BH-08-20	1/2 - 14	20 X 1.5
IA-19BH-08-22	1/2 - 14	22 X 1.5
IA-19BH-10-20	5/8 - 14	20 X 1.5
IA-19BH-10-22	5/8 - 14	22 X 1.5
IA-19BH-12-22	3/4 - 14	22 X 1.5
IA-19BH-12-26	3/4 - 14	26 X 1.5
IA-19BH-12-27	3/4 - 14	27 X 2.0
IA-19BH-16-27	1 - 11	27 X 2.0
IA-19BH-16-33	1 - 11	33 X 2.0
IA-19BH-20-42	1 1/4 - 11	42 X 2.0
IA-19BH-24-48	1 1/2 - 11	48 X 2.0

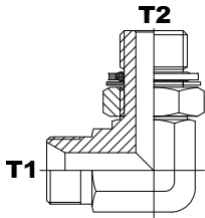

*All "B" Male Threads have 60° Seat.

*All "G" Threads come with O-Ring / Washer combination for external port sealing.

IA-ABBH

BSPP MALE x METRIC PORT ADJ. MALE BR TEE

PART NUMBER	T1	T2	T3
	IA-ABBH-02-02-10	1/8 - 28	1/8 - 28
IA-ABBH-02-02-12	1/8 - 28	1/8 - 28	12 X 1.5
IA-ABBH-04-04-12	1/4 - 19	1/4 - 19	12 X 1.5
IA-ABBH-04-04-14	1/4 - 19	1/4 - 19	14 X 1.5
IA-ABBH-04-04-16	1/4 - 19	1/4 - 19	16 X 1.5
IA-ABBH-06-06-14	3/8 - 19	3/8 - 19	14 X 1.5
IA-ABBH-06-06-16	3/8 - 19	3/8 - 19	16 X 1.5
IA-ABBH-06-06-18	3/8 - 19	3/8 - 19	18 X 1.5
IA-ABBH-08-08-18	1/2 - 14	1/2 - 14	18 X 1.5
IA-ABBH-08-08-20	1/2 - 14	1/2 - 14	20 X 1.5
IA-ABBH-08-08-22	1/2 - 14	1/2 - 14	22 X 1.5
IA-ABBH-10-10-22	5/8 - 14	5/8 - 14	22 X 1.5
IA-ABBH-12-12-27	3/4 - 14	3/4 - 14	27 X 2.0
IA-ABBH-16-16-33	1 - 11	1 - 11	33 X 2.0
IA-ABBH-20-20-42	1 1/4 - 11	1 1/4 - 11	42 X 2.0
IA-ABBH-24-24-48	1 1/2 - 11	1 1/2 - 11	48 X 2.0

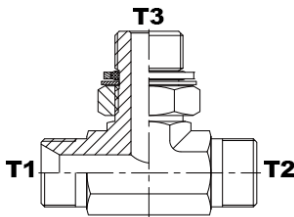

*All "B" Male Threads have 60° Seat.

*All "G" Threads come with O-Ring / Washer combination for external port sealing.

IA-ABHB

BSPP MALE x METRIC PORT ADJ. MALE RUN TEE

PART NUMBER	T1	T2	T3
	IA-ABHB-02-10-02	1/8 - 28	10 X 1.0
IA-ABHB-06-16-06	3/8 - 19	16 X 1.5	3/8 - 19
IA-ABHB-12-27-12	3/4 - 14	27 X 2.0	3/4 - 14

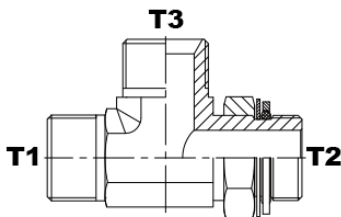

*All "B" Male Threads have 60° Seat.

*All "G" Threads come with O-Ring / Washer combination for external port sealing.



WARNING This product can expose you to chemicals, which are known to the State of California to cause cancer or birth defects or other reproductive harm. For more information visit <https://www.p65warnings.ca.gov/>

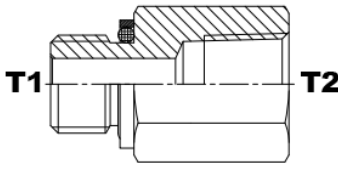

IA-50GN BSPP MALE PORT x NPT FEMALE RIGID

	PART NUMBER	T1	T2
	IA-50GN-02-02	1/8 - 28	1/8 - 27
IA-50GN-02-04	1/8 - 28	1/4 - 18	
IA-50GN-04-02	1/4 - 19	1/8 - 27	
IA-50GN-04-04	1/4 - 19	1/4 - 18	
IA-50GN-06-04	3/8 - 19	1/4 - 18	
IA-50GN-06-06	3/8 - 19	3/8 - 18	
IA-50GN-06-08	3/8 - 19	1/2 - 14	
IA-50GN-08-06	1/2 - 14	3/8 - 18	
IA-50GN-08-08	1/2 - 14	1/2 - 14	
IA-50GN-08-12	1/2 - 14	3/4 - 14	
IA-50GN-12-08	3/4 - 14	1/2 - 14	
IA-50GN-12-12	3/4 - 14	3/4 - 14	
IA-50GN-16-16	1 - 11	1 - 11 1/2	
IA-50GN-20-20	1 1/4 - 11	1 1/4 - 11 1/2	
IA-50GN-24-24	1 1/2 - 11	1 1/2 - 11 1/2	

*All "B" Male Threads have 60° Seat.

*All "G" Threads come with O-Ring / Washer combination for external port sealing.

IA-10JG JIC MALE x BSPP PORT MALE

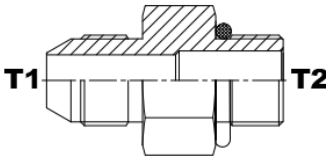
	PART NUMBER	T1	T2
	IA-10JG-04-02	7/16 - 20	1/8 - 28
IA-10JG-04-04	7/16 - 20	1/4 - 19	
IA-10JG-04-06	7/16 - 20	3/8 - 19	
IA-10JG-04-08	7/16 - 20	1/2 - 14	
IA-10JG-05-02	1/2 - 20	1/8 - 28	
IA-10JG-05-04	1/2 - 20	1/4 - 19	
IA-10JG-05-06	1/2 - 20	3/8 - 19	
IA-10JG-05-08	1/2 - 20	1/2 - 14	
IA-10JG-05-12	1/2 - 20	3/4 - 14	
IA-10JG-06-02	9/16 - 18	1/8 - 28	
IA-10JG-06-04	9/16 - 18	1/4 - 19	
IA-10JG-06-06	9/16 - 18	3/8 - 19	
IA-10JG-06-08	9/16 - 18	1/2 - 14	
IA-10JG-08-04	3/4 - 16	1/4 - 19	
IA-10JG-08-06	3/4 - 16	3/8 - 19	
IA-10JG-08-08	3/4 - 16	1/2 - 14	
IA-10JG-08-12	3/4 - 16	3/4 - 14	
IA-10JG-10-06	7/8 - 14	3/8 - 19	
IA-10JG-10-08	7/8 - 14	1/2 - 14	
IA-10JG-10-12	7/8 - 14	3/4 - 14	
IA-10JG-10-16	7/8 - 14	1 - 11	
IA-10JG-12-06	1 1/16 - 12	3/8 - 19	
IA-10JG-12-08	1 1/16 - 12	1/2 - 14	
IA-10JG-12-12	1 1/16 - 12	3/4 - 14	
IA-10JG-12-16	1 1/16 - 12	1 - 11	
IA-10JG-12-20	1 1/16 - 12	1 1/4 - 11	
IA-10JG-16-12	1 5/16 - 12	3/4 - 14	
IA-10JG-16-16	1 5/16 - 12	1 - 11	
IA-10JG-16-20	1 5/16 - 12	1 1/4 - 11	
IA-10JG-16-24	1 5/16 - 12	1 1/2 - 11	
IA-10JG-20-16	1 5/8 - 12	1 - 11	
IA-10JG-20-20	1 5/8 - 12	1 1/4 - 11	
IA-10JG-24-16	1 7/8 - 12	1 - 11	
IA-10JG-24-20	1 7/8 - 12	1 1/4 - 11	
IA-10JG-24-24	1 7/8 - 12	1 1/2 - 11	

*All "B" Male Threads have 60° Seat.

*All "G" Threads come with O-Ring / Washer combination for external port sealing.



WARNING This product can expose you to chemicals, which are known to the State of California to cause cancer or birth defects or other reproductive harm. For more information visit <https://www.p65warnings.ca.gov/>

IA-14JG

JIC MALE x 45° BSPP PORT ADJ. MALE

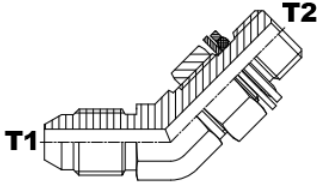
	PART NUMBER	T1	T2
	IA-14JG-04-02	7/16 - 20	1/8 - 28
	IA-14JG-04-04	7/16 - 20	1/4 - 19
	IA-14JG-06-04	9/16 - 18	1/4 - 19
	IA-14JG-06-06	9/16 - 18	3/8 - 19
	IA-14JG-06-08	9/16 - 18	1/2 - 14
	IA-14JG-08-06	3/4 - 16	3/8 - 19
	IA-14JG-08-08	3/4 - 16	1/2 - 14
	IA-14JG-10-08	7/8 - 14	1/2 - 14
	IA-14JG-12-08	1 1/16 - 12	1/2 - 14
	IA-14JG-12-12	1 1/16 - 12	3/4 - 14
	IA-14JG-12-16	1 1/16 - 12	1 - 11
	IA-14JG-16-16	1 5/16 - 12	1 - 11

*All "B" Male Threads have 60° Seat.

*All "G" Threads come with O-Ring / Washer combination for external port sealing.

IA-19JG

JIC MALE x 90° BSPP PORT ADJ. MALE

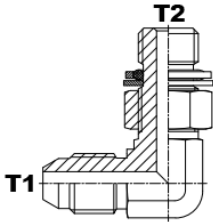
	PART NUMBER	T1	T2
	IA-19JG-04-02	7/16 - 20	1/8 - 28
	IA-19JG-04-04	7/16 - 20	1/4 - 19
	IA-19JG-04-06	7/16 - 20	3/8 - 19
	IA-19JG-04-08	7/16 - 20	1/2 - 14
	IA-19JG-05-02	1/2 - 20	1/8 - 28
	IA-19JG-05-04	1/2 - 20	1/4 - 19
	IA-19JG-05-06	1/2 - 20	3/8 - 19
	IA-19JG-06-02	9/16 - 18	1/8 - 28
	IA-19JG-06-04	9/16 - 18	1/4 - 19
	IA-19JG-06-06	9/16 - 18	3/8 - 19
	IA-19JG-06-08	9/16 - 18	1/2 - 14
	IA-19JG-08-04	3/4 - 16	1/4 - 19
	IA-19JG-08-06	3/4 - 16	3/8 - 19
	IA-19JG-08-08	3/4 - 16	1/2 - 14
	IA-19JG-08-10	3/4 - 16	5/8 - 14
	IA-19JG-08-12	3/4 - 16	3/4 - 14
	IA-19JG-10-06	7/8 - 14	3/8 - 19
	IA-19JG-10-08	7/8 - 14	1/2 - 14
	IA-19JG-10-10	7/8 - 14	5/8 - 14
	IA-19JG-10-12	7/8 - 14	3/4 - 14
	IA-19JG-12-08	1 1/16 - 12	1/2 - 14
	IA-19JG-12-12	1 1/16 - 12	3/4 - 14
	IA-19JG-12-16	1 1/16 - 12	1 - 11
	IA-19JG-16-12	1 5/16 - 12	3/4 - 14
	IA-19JG-16-16	1 5/16 - 12	1 - 11
	IA-19JG-16-20	1 5/16 - 12	1 1/4 - 11
IA-19JG-20-16	1 5/8 - 12	1 - 11	
IA-19JG-20-20	1 5/8 - 12	1 1/4 - 11	
IA-19JG-24-24	1 7/8 - 12	1 1/2 - 11	

*All "B" Male Threads have 60° Seat.

*All "G" Threads come with O-Ring / Washer combination for external port sealing.



WARNING This product can expose you to chemicals, which are known to the State of California to cause cancer or birth defects or other reproductive harm. For more information visit <https://www.p65warnings.ca.gov/>

IA-AJJG

JIC MALE x BSPP PORT ADJ. MALE BR. TEE

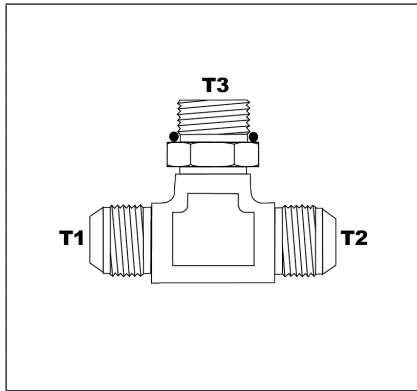

PART NUMBER	T1	T2	T3
IA-AJJG-04-04-04	7/16 - 20	7/16 - 20	1/4 - 19
IA-AJJG-06-06-04	9/16 - 18	9/16 - 18	1/4 - 19
IA-AJJG-06-06-06	9/16 - 18	9/16 - 18	3/8 - 19
IA-AJJG-08-08-06	3/4 - 16	3/4 - 16	3/8 - 19
IA-AJJG-08-08-08	3/4 - 16	3/4 - 16	1/2 - 14
IA-AJJG-10-10-08	7/8 - 14	7/8 - 14	1/2 - 14
IA-AJJG-12-12-12	1 1/16 - 12	1 1/16 - 12	3/4 - 14
IA-AJJG-16-16-16	1 5/16 - 12	1 5/16 - 12	1 - 11

*All "B" Male Threads have 60° Seat.

*All "G" Threads come with O-Ring / Washer combination for external port sealing.

IA-AJGJ

JIC MALE x BSPP PORT ADJ. MALE RUN TEE

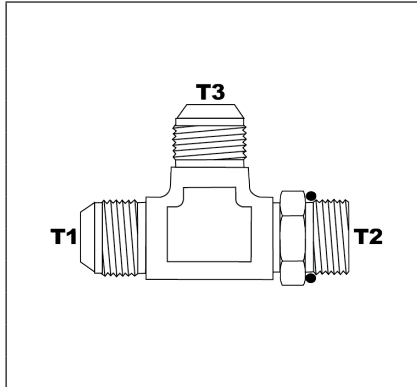

PART NUMBER	T1	T2	T3
IA-AJGJ-04-02-04	7/16 - 20	1/8 - 28	7/16 - 20
IA-AJGJ-04-04-04	7/16 - 20	1/4 - 19	7/16 - 20
IA-AJGJ-06-04-06	9/16 - 18	1/4 - 19	9/16 - 18
IA-AJGJ-06-06-06	9/16 - 18	3/8 - 19	9/16 - 18
IA-AJGJ-08-06-08	3/4 - 16	3/8 - 19	3/4 - 16
IA-AJGJ-08-08-08	3/4 - 16	1/2 - 14	3/4 - 16
IA-AJGJ-12-12-12	1 1/16 - 12	3/4 - 14	1 1/16 - 12
IA-AJGJ-16-16-16	1 5/16 - 12	1 - 11	1 5/16 - 12

*All "B" Male Threads have 60° Seat.

*All "G" Threads come with O-Ring / Washer combination for external port sealing.

IA-20GJ

BSPP MALE PORT x JIC FEMALE SWIVEL

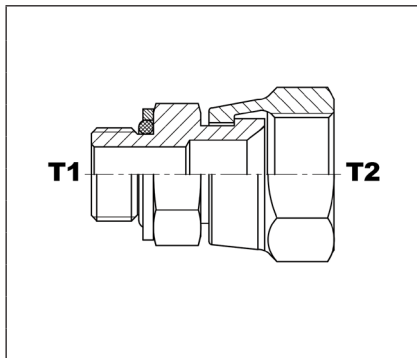

PART NUMBER	T1	T2
IA-20GJ-02-04	1/8 - 28	7/16 - 20
IA-20GJ-04-04	1/4 - 19	7/16 - 20
IA-20GJ-06-08	3/8 - 19	3/4 - 16
IA-20GJ-12-12	3/4 - 14	1 1/16 - 12
IA-20GJ-20-20	1 1/4 - 11	1 5/8 - 12

*All "B" Male Threads have 60° Seat.

*All "G" Threads come with O-Ring / Washer combination for external port sealing.

IA-29GJ

90° BSPP MALE PORT ADJ. x JIC FEMALE SWIVEL

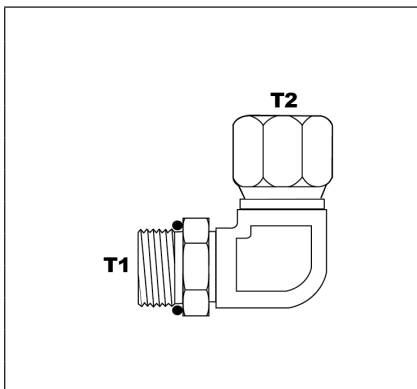

PART NUMBER	T1	T2
IA-29GJ-04-04	1/4 - 19	7/16 - 20
IA-29GJ-04-06	1/4 - 19	9/16 - 18
IA-29GJ-06-06	3/8 - 19	9/16 - 18
IA-29GJ-12-12	3/4 - 14	1 1/16 - 12
IA-29GJ-20-20	1 1/4 - 11	1 5/8 - 12

*All "B" Male Threads have 60° Seat.

*All "G" Threads come with O-Ring / Washer combination for external port sealing.

WARNING This product can expose you to chemicals, which are known to the State of California to cause cancer or birth defects or other reproductive harm. For more information visit <https://www.p65warnings.ca.gov/>

IA-10FG

ORFS MALE x BSPP PORT MALE

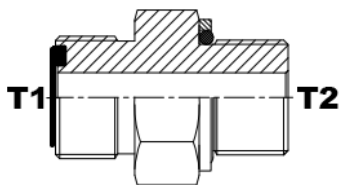

PART NUMBER	T1	T2
IA-10FG-04-02	9/16 - 18	1/8 - 28
IA-10FG-04-04	9/16 - 18	1/4 - 19
IA-10FG-04-06	9/16 - 18	3/8 - 19
IA-10FG-06-02	11/16 - 16	1/8 - 28
IA-10FG-06-04	11/16 - 16	1/4 - 19
IA-10FG-06-06	11/16 - 16	3/8 - 19
IA-10FG-06-08	11/16 - 16	1/2 - 14
IA-10FG-08-04	13/16 - 16	1/4 - 19
IA-10FG-08-06	13/16 - 16	3/8 - 19
IA-10FG-08-08	13/16 - 16	1/2 - 14
IA-10FG-08-12	13/16 - 16	1 1/2 - 11
IA-10FG-08-16	13/16 - 16	1 - 11
IA-10FG-10-06	1 - 14	3/8 - 19
IA-10FG-10-08	1 - 14	1/2 - 14
IA-10FG-10-12	1 - 14	3/4 - 14
IA-10FG-12-08	1 3/16 - 12	1/2 - 14
IA-10FG-12-12	1 3/16 - 12	3/4 - 14
IA-10FG-12-16	1 3/16 - 12	1 - 11
IA-10FG-16-12	1 7/16 - 12	3/4 - 14
IA-10FG-16-16	1 7/16 - 12	1 - 11
IA-10FG-16-20	1 7/16 - 12	1 1/4 - 11
IA-10FG-20-16	1 11/16 - 12	1 - 11
IA-10FG-20-20	1 11/16 - 12	1 1/4 - 11
IA-10FG-24-24	2 - 12	1 1/2 - 11

*All "B" Male Threads have 60° Seat.

*All "G" Threads come with O-Ring / Washer combination for external port sealing.

IA-14FG

ORFS MALE x 45° BSPP PORT ADJ. MALE

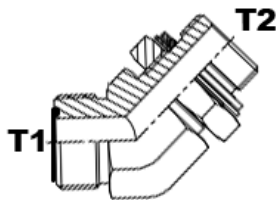

PART NUMBER	T1	T2
IA-14FG-04-02	9/16 - 18	1/8 - 28
IA-14FG-04-04	9/16 - 18	1/4 - 19
IA-14FG-06-04	11/16 - 16	1/4 - 19
IA-14FG-06-06	11/16 - 16	3/8 - 19
IA-14FG-08-06	13/16 - 16	3/8 - 19
IA-14FG-08-08	13/16 - 16	1/2 - 14
IA-14FG-10-08	1 - 14	1/2 - 14
IA-14FG-12-12	1 3/16 - 12	3/4 - 14
IA-14FG-12-16	1 3/16 - 12	1 - 11
IA-14FG-16-16	1 7/16 - 12	1 - 11

*All "B" Male Threads have 60° Seat.

*All "G" Threads come with O-Ring / Washer combination for external port sealing.



WARNING This product can expose you to chemicals, which are known to the State of California to cause cancer or birth defects or other reproductive harm. For more information visit <https://www.p65warnings.ca.gov/>



IA-19FG

ORFS MALE x 90° BSPP PORT ADJ. MALE

PART NUMBER	T1		T2	
IA-19FG-04-02	9/16 - 18		1/8 - 28	
IA-19FG-04-04	9/16 - 18		1/4 - 19	
IA-19FG-04-06	9/16 - 18		3/8 - 19	
IA-19FG-06-04	11/16 - 16		1/4 - 19	
IA-19FG-06-06	11/16 - 16		3/8 - 19	
IA-19FG-06-08	11/16 - 16		1/2 - 14	
IA-19FG-08-04	13/16 - 16		1/4 - 19	
IA-19FG-08-06	13/16 - 16		3/8 - 19	
IA-19FG-08-08	13/16 - 16		1/2 - 14	
IA-19FG-10-06	1 - 14		3/8 - 19	
IA-19FG-10-08	1 - 14		1/2 - 14	
IA-19FG-10-12	1 - 14		3/4 - 14	
IA-19FG-12-06	1 3/16 - 12		3/8 - 19	
IA-19FG-12-08	1 3/16 - 12		1/2 - 14	
IA-19FG-12-12	1 3/16 - 12		3/4 - 14	
IA-19FG-12-16	1 3/16 - 12		1 - 11	
IA-19FG-16-12	1 7/16 - 12		3/4 - 14	
IA-19FG-16-16	1 7/16 - 12		1 - 11	
IA-19FG-16-20	1 7/16 - 12		1 1/4 - 11	
IA-19FG-20-16	1 11/16 - 12		1 - 11	
IA-19FG-20-20	1 11/16 - 12		1 1/4 - 11	
IA-19FG-24-24	2 - 12		1 1/2 - 11	

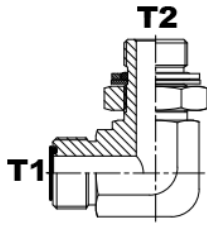

*All "B" Male Threads have 60° Seat.

*All "G" Threads come with O-Ring / Washer combination for external port sealing.

IA-AFFG

ORFS MALE x BSPP PORT ADJ. MALE BR. TEE

PART NUMBER	T1		T2		T3	
IA-AFFG-04-04-04	9/16 - 18		9/16 - 18		1/4 - 19	
IA-AFFG-06-06-06	11/16 - 16		11/16 - 16		3/8 - 19	
IA-AFFG-08-08-08	13/16 - 16		13/16 - 16		1/2 - 14	
IA-AFFG-12-12-12	1 3/16 - 12		1 3/16 - 12		3/4 - 14	
IA-AFFG-16-16-16	1 7/16 - 12		1 7/16 - 12		1 - 11	

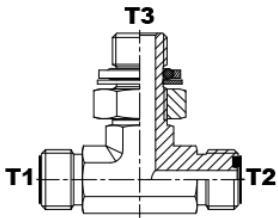

*All "B" Male Threads have 60° Seat.

*All "G" Threads come with O-Ring / Washer combination for external port sealing.

IA-AFGF

ORFS MALE x BSPP PORT ADJ. MALE RUN TEE

PART NUMBER	T1		T2		T3	
IA-AFGF-04-04-04	9/16 - 18		1/4 - 19		9/16 - 18	
IA-AFGF-06-04-06	11/16 - 16		1/4 - 19		11/16 - 16	
IA-AFGF-06-06-06	11/16 - 16		3/8 - 19		11/16 - 16	
IA-AFGF-08-06-08	13/16 - 16		3/8 - 19		13/16 - 16	
IA-AFGF-08-08-08	13/16 - 16		1/2 - 14		13/16 - 16	
IA-AFGF-10-10-08	1 - 14		5/8 - 14		13/16 - 16	
IA-AFGF-12-12-12	1 3/16 - 12		3/4 - 14		1 3/16 - 12	
IA-AFGF-16-16-16	1 7/16 - 12		1 - 11		1 7/16 - 12	

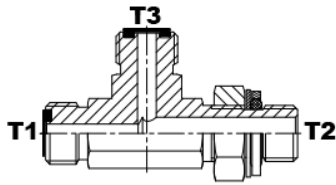

*All "B" Male Threads have 60° Seat.

*All "G" Threads come with O-Ring / Washer combination for external port sealing.

WARNING This product can expose you to chemicals, which are known to the State of California to cause cancer or birth defects or other reproductive harm. For more information visit <https://www.p65warnings.ca.gov/>

IA-10NT

NPT MALE x BSPT MALE

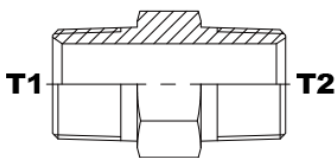
	PART NUMBER	T1	T2
	IA-10NT-02-02	1/8 - 27	1/8 - 28
IA-10NT-04-04	1/4 - 18	1/4 - 19	
IA-10NT-04-06	1/4 - 18	3/8 - 19	
IA-10NT-06-04	3/8 - 18	1/4 - 19	
IA-10NT-06-06	3/8 - 18	3/8 - 19	
IA-10NT-08-08	1/2 - 14	1/2 - 14	
IA-10NT-12-12	3/4 - 14	3/4 - 14	
IA-10NT-16-16	1 - 11 1/2	1 - 11	
IA-10NT-20-20	1 1/4 - 11 1/2	1 1/4 - 11	
IA-10NT-24-24	1 1/2 - 11 1/2	1 1/2 - 11	
IA-10NT-32-32	2 - 11 1/2	2 - 11	

*All "B" Male Threads have 60° Seat.

*All "G" Threads come with O-Ring / Washer combination for external port sealing.

IA-50TN

BSPT MALE x NPT FEMALE RIGID

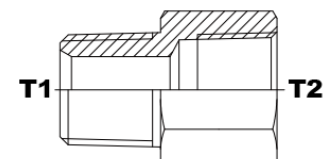
	PART NUMBER	T1	T2
	IA-50TN-02-02	1/8 - 28	1/8 - 27
IA-50TN-02-04	1/8 - 28	1/4 - 18	
IA-50TN-04-02	1/4 - 19	1/8 - 27	
IA-50TN-04-04	1/4 - 19	1/4 - 18	
IA-50TN-06-02	3/8 - 19	1/8 - 27	
IA-50TN-06-04	3/8 - 19	1/4 - 18	
IA-50TN-06-06	3/8 - 19	3/8 - 18	
IA-50TN-08-04	1/2 - 14	1/4 - 18	
IA-50TN-08-06	1/2 - 14	3/8 - 18	
IA-50TN-08-08	1/2 - 14	1/2 - 14	
IA-50TN-12-08	3/4 - 14	1/2 - 14	
IA-50TN-12-12	3/4 - 14	3/4 - 14	
IA-50TN-16-16	1 - 11	1 - 11 1/2	
IA-50TN-20-20	1 1/4 - 11	1 1/4 - 11 1/2	
IA-50TN-24-24	1 1/2 - 11	1 1/2 - 11 1/2	

*All "B" Male Threads have 60° Seat.

*All "G" Threads come with O-Ring / Washer combination for external port sealing.

IA-50NT

NPT MALE x BSPT FEMALE RIGID

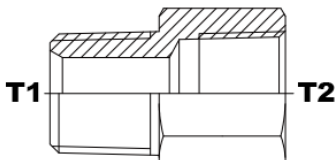
	PART NUMBER	T1	T2
	IA-50NT-02-02	1/8 - 27	1/8 - 28
IA-50NT-04-02	1/4 - 18	1/8 - 28	
IA-50NT-04-04	1/4 - 18	1/4 - 19	
IA-50NT-04-06	1/4 - 18	3/8 - 19	
IA-50NT-06-04	3/8 - 18	1/4 - 19	
IA-50NT-06-06	3/8 - 18	3/8 - 19	
IA-50NT-06-08	3/8 - 18	1/2 - 14	
IA-50NT-08-06	1/2 - 14	3/8 - 19	
IA-50NT-08-08	1/2 - 14	1/2 - 14	
IA-50NT-08-12	1/2 - 14	3/4 - 14	
IA-50NT-12-08	3/4 - 14	1/2 - 14	
IA-50NT-12-12	3/4 - 14	3/4 - 14	
IA-50NT-12-16	3/4 - 14	1 - 11	
IA-50NT-16-12	1 - 11 1/2	3/4 - 14	
IA-50NT-16-16	1 - 11 1/2	1 - 11	
IA-50NT-16-20	1 - 11 1/2	1 1/4 - 11	
IA-50NT-20-16	1 1/4 - 11 1/2	1 - 11	
IA-50NT-20-20	1 1/4 - 11 1/2	1 1/4 - 11	
IA-50NT-20-24	1 1/4 - 11 1/2	1 1/2 - 11	
IA-50NT-24-24	1 1/2 - 11 1/2	1 1/2 - 11	
IA-50NT-32-32	2 - 11 1/2	2 - 11	

*All "B" Male Threads have 60° Seat.

*All "G" Threads come with O-Ring / Washer combination for external port sealing.



WARNING This product can expose you to chemicals, which are known to the State of California to cause cancer or birth defects or other reproductive harm. For more information visit <https://www.p65warnings.ca.gov/>

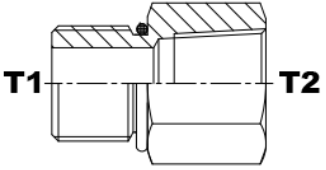

IA-500T M-ORB x BSPT FEMALE RIGID

 <p>*Quoted Upon Request</p>	PART NUMBER	T1	T2

*All "B" Male Threads have 60° Seat.

*All "G" Threads come with O-Ring / Washer combination for external port sealing.

IA-10JT JIC MALE x BSPT MALE

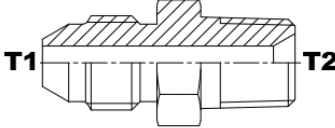
	PART NUMBER	T1	T2
	IA-10JT-02-02	5/16 - 24	1/8 - 28
	IA-10JT-04-02	7/16 - 20	1/8 - 28
	IA-10JT-04-04	7/16 - 20	1/4 - 19
	IA-10JT-04-06	7/16 - 20	3/8 - 19
	IA-10JT-04-08	7/16 - 20	1/2 - 14
	IA-10JT-05-04	1/2 - 20	1/4 - 19
	IA-10JT-05-06	1/2 - 20	3/8 - 19
	IA-10JT-06-02	9/16 - 18	1/8 - 28
	IA-10JT-06-04	9/16 - 18	1/4 - 19
	IA-10JT-06-06	9/16 - 18	3/8 - 19
	IA-10JT-06-08	9/16 - 18	1/2 - 14
	IA-10JT-08-04	3/4 - 16	1/4 - 19
	IA-10JT-08-06	3/4 - 16	3/8 - 19
	IA-10JT-08-08	3/4 - 16	1/2 - 14
	IA-10JT-08-12	3/4 - 16	3/4 - 14
	IA-10JT-08-16	3/4 - 16	1 - 11
	IA-10JT-10-06	7/8 - 14	3/8 - 19
	IA-10JT-10-08	7/8 - 14	1/2 - 14
	IA-10JT-12-08	1 1/16 - 12	1/2 - 14
	IA-10JT-12-12	1 1/16 - 12	3/4 - 14
	IA-10JT-12-16	1 1/16 - 12	1 - 11
	IA-10JT-14-12	1 3/16 - 12	3/4 - 14
	IA-10JT-16-08	1 5/16 - 12	1/2 - 14
	IA-10JT-16-12	1 5/16 - 12	3/4 - 14
	IA-10JT-16-16	1 5/16 - 12	1 - 11
	IA-10JT-20-20	1 5/8 - 12	1 1/4 - 11
IA-10JT-24-24	1 7/8 - 12	1 1/2 - 11	
IA-10JT-32-32	2 1/2 - 12	2 - 11	

*All "B" Male Threads have 60° Seat.

*All "G" Threads come with O-Ring / Washer combination for external port sealing.

IA-14JT JIC MALE x 45° BSPT MALE

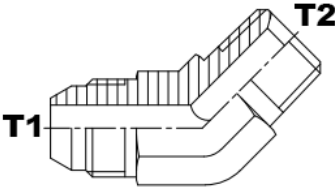
	PART NUMBER	T1	T2
	IA-14JT-04-02	7/16 - 20	1/8 - 28
	IA-14JT-04-04	7/16 - 20	1/4 - 19
	IA-14JT-06-04	9/16 - 18	1/4 - 19
	IA-14JT-06-06	9/16 - 18	3/8 - 19
	IA-14JT-08-06	3/4 - 16	3/8 - 19
	IA-14JT-08-08	3/4 - 16	1/2 - 14
	IA-14JT-10-08	7/8 - 14	1/2 - 14
	IA-14JT-12-12	1 1/16 - 12	3/4 - 14
	IA-14JT-16-16	1 5/16 - 12	1 - 11

*All "B" Male Threads have 60° Seat.

*All "G" Threads come with O-Ring / Washer combination for external port sealing.



WARNING This product can expose you to chemicals, which are known to the State of California to cause cancer or birth defects or other reproductive harm. For more information visit <https://www.p65warnings.ca.gov/>

IA-10BB

BSPP MALE UNION 60° SEATS

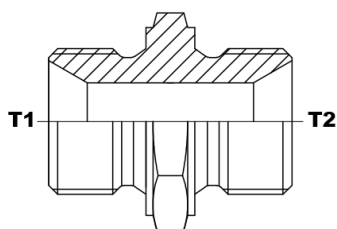

PART NUMBER	T1	T2
IA-10BB-02-02	1/8 - 28	1/8 - 28
IA-10BB-04-02	1/4 - 19	1/8 - 28
IA-10BB-04-04	1/4 - 19	1/4 - 19
IA-10BB-06-02	3/8 - 19	1/8 - 28
IA-10BB-06-04	3/8 - 19	1/4 - 19
IA-10BB-06-06	3/8 - 19	3/8 - 19
IA-10BB-08-02	1/2 - 14	1/8 - 28
IA-10BB-08-04	1/2 - 14	1/4 - 19
IA-10BB-08-06	1/2 - 14	3/8 - 19
IA-10BB-08-08	1/2 - 14	1/2 - 14
IA-10BB-10-04	5/8 - 14	1/4 - 19
IA-10BB-10-06	5/8 - 14	3/8 - 19
IA-10BB-10-08	5/8 - 14	1/2 - 14
IA-10BB-10-10	5/8 - 14	5/8 - 14
IA-10BB-12-04	3/4 - 14	1/4 - 19
IA-10BB-12-06	3/4 - 14	3/8 - 19
IA-10BB-12-08	3/4 - 14	1/2 - 14
IA-10BB-12-10	3/4 - 14	5/8 - 14
IA-10BB-12-12	3/4 - 14	3/4 - 14
IA-10BB-16-04	1 - 11	1/4 - 19
IA-10BB-16-06	1 - 11	3/8 - 19
IA-10BB-16-08	1 - 11	1/2 - 14
IA-10BB-16-10	1 - 11	5/8 - 14
IA-10BB-16-12	1 - 11	3/4 - 14
IA-10BB-16-16	1 - 11	1 - 11
IA-10BB-20-06	1 1/4 - 11	3/8 - 19
IA-10BB-20-08	1 1/4 - 11	1/2 - 14
IA-10BB-20-10	1 1/4 - 11	5/8 - 14
IA-10BB-20-12	1 1/4 - 11	3/4 - 14
IA-10BB-20-16	1 1/4 - 11	1 - 11
IA-10BB-20-20	1 1/4 - 11	1 1/4 - 11
IA-10BB-24-08	1 1/2 - 11	1/2 - 14
IA-10BB-24-10	1 1/2 - 11	5/8 - 14
IA-10BB-24-12	1 1/2 - 11	3/4 - 14
IA-10BB-24-16	1 1/2 - 11	1 - 11
IA-10BB-24-20	1 1/2 - 11	1 1/4 - 11
IA-10BB-24-24	1 1/2 - 11	1 1/2 - 11
IA-10BB-32-16	2 - 11	1 - 11
IA-10BB-32-20	2 - 11	1 1/4 - 11
IA-10BB-32-24	2 - 11	1 1/2 - 11
IA-10BB-32-32	2 - 11	2 - 11
IA-10BB-40-24	2 1/2 - 11	1 1/2 - 11
IA-10BB-40-32	2 1/2 - 11	2 - 11
IA-10BB-40-40	2 1/2 - 11	2 1/2 - 11
IA-10BB-48-32	3 - 11	2 - 11
IA-10BB-48-40	3 - 11	2 1/2 - 11
IA-10BB-48-48	3 - 11	3 - 11

BSPP (60° SEAT)



WARNING This product can expose you to chemicals, which are known to the State of California to cause cancer or birth defects or other reproductive harm. For more information visit <https://www.p65warnings.ca.gov/>



IA-10BB-WD

BSPP MALE UNION 60° SEALS + CAPTIVE SEAL

	PART NUMBER	T1	T2
	IA-10BB-02-02-WD	1/8 - 28	1/8 - 28
	IA-10BB-04-04-WD	1/4 - 19	1/4 - 19
	IA-10BB-06-06-WD	3/8 - 19	3/8 - 19
	IA-10BB-08-08-WD	1/2 - 14	1/2 - 14
	IA-10BB-12-12-WD	3/4 - 14	3/4 - 14
	IA-10BB-16-16-WD	1 - 11	1 - 11
	IA-10BB-20-20-WD	1 1/4 - 11	1 1/4 - 11

IA-14BB

45° BSPP MALE UNION

	PART NUMBER	T1	T2
	IA-14BB-02-02	1/8 - 28	1/8 - 28
	IA-14BB-04-04	1/4 - 19	1/4 - 19
	IA-14BB-06-04	3/8 - 19	1/4 - 19
	IA-14BB-06-06	3/8 - 19	3/8 - 19
	IA-14BB-08-06	1/2 - 14	3/8 - 19
	IA-14BB-08-08	1/2 - 14	1/2 - 14
	IA-14BB-10-10	5/8 - 14	5/8 - 14
	IA-14BB-12-08	3/4 - 14	1/2 - 14
	IA-14BB-12-10	3/4 - 14	5/8 - 14
	IA-14BB-12-12	3/4 - 14	3/4 - 14
	IA-14BB-16-12	1 - 11	3/4 - 14
	IA-14BB-16-16	1 - 11	1 - 11
	IA-14BB-20-20	1 1/4 - 11	1 1/4 - 11
	IA-14BB-24-24	1 1/2 - 11	1 1/2 - 11
	IA-14BB-32-32	2 - 11	2 - 11

IA-19BB

90° BSPP MALE UNION

	PART NUMBER	T1	T2
	IA-19BB-02-02	1/8 - 28	1/8 - 28
	IA-19BB-04-04	1/4 - 19	1/4 - 19
	IA-19BB-06-04	3/8 - 19	1/4 - 19
	IA-19BB-06-06	3/8 - 19	3/8 - 19
	IA-19BB-08-06	1/2 - 14	3/8 - 19
	IA-19BB-08-08	1/2 - 14	1/2 - 14
	IA-19BB-10-10	5/8 - 14	5/8 - 14
	IA-19BB-12-08	3/4 - 14	1/2 - 14
	IA-19BB-12-12	3/4 - 14	3/4 - 14
	IA-19BB-16-12	1 - 11	3/4 - 14
	IA-19BB-16-16	1 - 11	1 - 11
	IA-19BB-20-20	1 1/4 - 11	1 1/4 - 11
	IA-19BB-24-24	1 1/2 - 11	1 1/2 - 11
IA-19BB-32-32	2 - 11	2 - 11	

WARNING This product can expose you to chemicals, which are known to the State of California to cause cancer or birth defects or other reproductive harm. For more information visit <https://www.p65warnings.ca.gov/>

IA-ABBB BSPP MALE UNION TEE

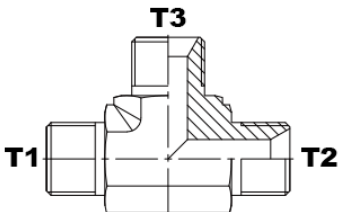
	PART NUMBER	T1	T2	T3
	IA-ABBB-02-02-02	1/8 - 28	1/8 - 28	1/8 - 28
	IA-ABBB-04-04-04	1/4 - 19	1/4 - 19	1/4 - 19
	IA-ABBB-06-06-06	3/8 - 19	3/8 - 19	3/8 - 19
	IA-ABBB-08-08-08	1/2 - 14	1/2 - 14	1/2 - 14
	IA-ABBB-10-10-10	5/8 - 14	5/8 - 14	5/8 - 14
	IA-ABBB-12-12-12	3/4 - 14	3/4 - 14	3/4 - 14
	IA-ABBB-16-16-16	1 - 11	1 - 11	1 - 11
	IA-ABBB-20-20-20	1 1/4 - 11	1 1/4 - 11	1 1/4 - 11
	IA-ABBB-24-24-24	1 1/2 - 11	1 1/2 - 11	1 1/2 - 11

IA-XBBBB BSPP MALE UNION CROSS

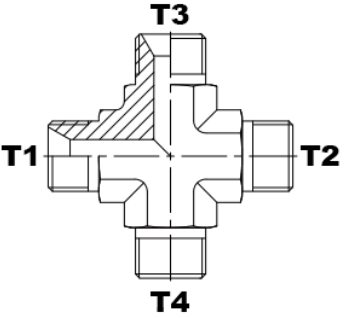
	PART NUMBER	T1	T2	T3	T4
	IA-XBBBB-04-04-04-04	1/4 - 19	1/4 - 19	1/4 - 19	
	IA-XBBBB-06-06-06-06	3/8 - 19	3/8 - 19	3/8 - 19	
	IA-XBBBB-08-08-08-08	1/2 - 14	1/2 - 14	1/2 - 14	
	IA-XBBBB-10-10-10-10	5/8 - 14	5/8 - 14	5/8 - 14	
	IA-XBBBB-12-12-12-12	3/4 - 14	3/4 - 14	3/4 - 14	
	IA-XBBBB-16-16-16-16	1 - 11	1 - 11	1 - 11	
	IA-XBBBB-20-20-20-20	1 1/4 - 11	1 1/4 - 11	1 1/4 - 11	
	IA-XBBBB-24-24-24-24	1 1/2 - 11	1 1/2 - 11	1 1/2 - 11	

WARNING This product can expose you to chemicals, which are known to the State of California to cause cancer or birth defects or other reproductive harm. For more information visit <https://www.p65warnings.ca.gov/>



IA-20BB

BSPP MALE x FEMALE SWIVEL

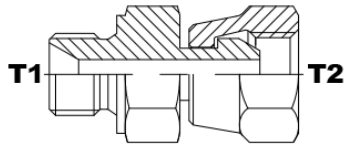

PART NUMBER	T1	T2
IA-20BB-02-02	1/8 - 28	1/8 - 28
IA-20BB-02-04	1/8 - 28	1/4 - 19
IA-20BB-04-02	1/4 - 19	1/8 - 28
IA-20BB-04-04	1/4 - 19	1/4 - 19
IA-20BB-04-06	1/4 - 19	3/8 - 19
IA-20BB-04-08	1/4 - 19	1/2 - 14
IA-20BB-06-04	3/8 - 19	1/4 - 19
IA-20BB-06-06	3/8 - 19	3/8 - 19
IA-20BB-06-08	3/8 - 19	1/2 - 14
IA-20BB-06-12	3/8 - 19	3/4 - 14
IA-20BB-08-04	1/2 - 14	1/4 - 19
IA-20BB-08-06	1/2 - 14	3/8 - 19
IA-20BB-08-08	1/2 - 14	1/2 - 14
IA-20BB-08-10	1/2 - 14	5/8 - 14
IA-20BB-08-12	1/2 - 14	3/4 - 14
IA-20BB-08-16	1/2 - 14	1 - 11
IA-20BB-10-08	5/8 - 14	1/2 - 14
IA-20BB-10-10	5/8 - 14	5/8 - 14
IA-20BB-10-12	5/8 - 14	3/4 - 14
IA-20BB-12-06	3/4 - 14	3/8 - 19
IA-20BB-12-08	3/4 - 14	1/2 - 14
IA-20BB-12-10	3/4 - 14	5/8 - 14
IA-20BB-12-12	3/4 - 14	3/4 - 14
IA-20BB-12-16	3/4 - 14	1 - 11
IA-20BB-12-20	3/4 - 14	1 1/4 - 11
IA-20BB-16-08	1 - 11	1/2 - 14
IA-20BB-16-10	1 - 11	5/8 - 14
IA-20BB-16-12	1 - 11	3/4 - 14
IA-20BB-16-16	1 - 11	1 - 11
IA-20BB-16-20	1 - 11	1 1/4 - 11
IA-20BB-20-12	1 1/4 - 11	3/4 - 14
IA-20BB-20-16	1 1/4 - 11	1 - 11
IA-20BB-20-20	1 1/4 - 11	1 1/4 - 11
IA-20BB-20-24	1 1/4 - 11	1 1/2 - 11
IA-20BB-20-32	1 1/4 - 11	2 - 11
IA-20BB-24-16	1 1/2 - 11	1 - 11
IA-20BB-24-20	1 1/2 - 11	1 1/4 - 11
IA-20BB-24-24	1 1/2 - 11	1 1/2 - 11
IA-20BB-32-32	2 - 11	2 - 11

IA-24BB

BSPP MALE x 45° FEMALE SWIVEL

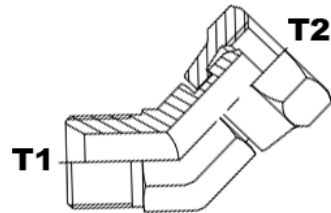

PART NUMBER	T1	T2
IA-24BB-04-04	1/4 - 19	1/4 - 19
IA-24BB-06-06	3/8 - 19	3/8 - 19
IA-24BB-08-08	1/2 - 14	1/2 - 14
IA-24BB-12-12	3/4 - 14	3/4 - 14
IA-24BB-16-16	1 - 11	1 - 11

⚠ WARNING This product can expose you to chemicals, which are known to the State of California to cause cancer or birth defects or other reproductive harm. For more information visit <https://www.p65warnings.ca.gov/>

IA-24BB-T BSPP MALE x 45° FEMALE SWIVEL TUBE TYPE

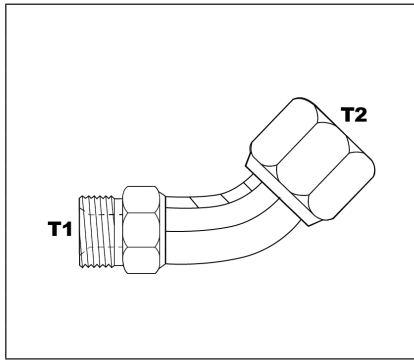

PART NUMBER	T1	T2
IA-24BB-04-04-T	1/4 - 19	1/4 - 19
IA-24BB-06-06-T	3/8 - 19	3/8 - 19
IA-24BB-08-08-T	1/2 - 14	1/2 - 14
IA-24BB-10-10-T	5/8 - 14	5/8 - 14
IA-24BB-12-12-T	3/4 - 14	3/4 - 14
IA-24BB-16-16-T	1 - 11	1 - 11
IA-24BB-20-20-T	1 1/4 - 11	1 1/4 - 11

IA-29BB BSPP MALE x 90° FEMALE SWIVEL

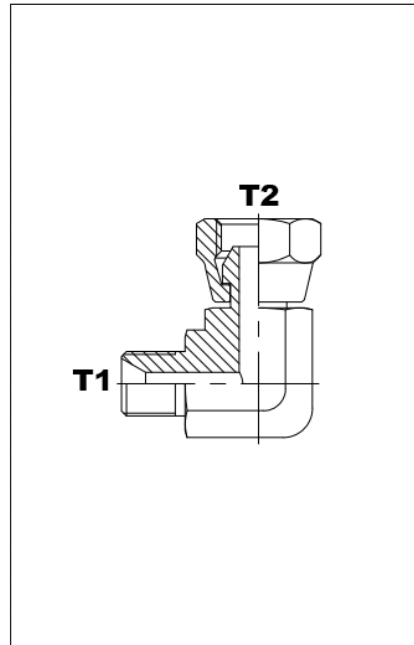

PART NUMBER	T1	T2
IA-29BB-02-02	1/8 - 28	1/8 - 28
IA-29BB-04-04	1/4 - 19	1/4 - 19
IA-29BB-04-06	1/4 - 19	3/8 - 19
IA-29BB-06-04	3/8 - 19	1/4 - 19
IA-29BB-06-06	3/8 - 19	3/8 - 19
IA-29BB-06-08	3/8 - 19	1/2 - 14
IA-29BB-08-06	1/2 - 14	3/8 - 19
IA-29BB-08-08	1/2 - 14	1/2 - 14
IA-29BB-08-10	1/2 - 14	5/8 - 14
IA-29BB-08-12	1/2 - 14	3/4 - 14
IA-29BB-10-10	5/8 - 14	5/8 - 14
IA-29BB-12-08	3/4 - 14	1/2 - 14
IA-29BB-12-12	3/4 - 14	3/4 - 14
IA-29BB-12-16	3/4 - 14	1 - 11
IA-29BB-16-12	1 - 11	3/4 - 14
IA-29BB-16-16	1 - 11	1 - 11
IA-29BB-20-20	1 1/4 - 11	1 1/4 - 11
IA-29BB-24-24	1 1/2 - 11	1 1/2 - 11
IA-29BB-32-32	2 - 11	2 - 11

IA-29BB-T BSPP MALE x 90° FEMALE SWIVEL TUBE TYPE

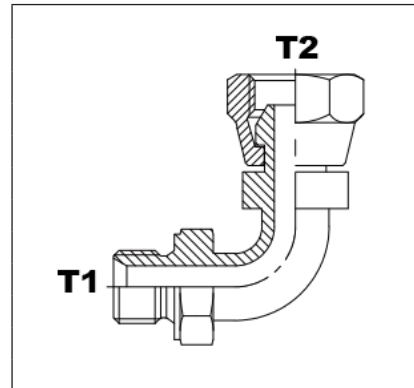

PART NUMBER	T1	T2
IA-29BB-04-04-T	1/4 - 19	1/4 - 19
IA-29BB-06-06-T	3/8 - 19	3/8 - 19
IA-29BB-08-08-T	1/2 - 14	1/2 - 14
IA-29BB-10-10-T	5/8 - 14	5/8 - 14
IA-29BB-12-12-T	3/4 - 14	3/4 - 14
IA-29BB-16-16-T	1 - 11	1 - 11
IA-29BB-20-20-T	1 1/4 - 11	1 1/4 - 11
IA-29BB-24-24-T	1 1/2 - 11	1 1/2 - 11
IA-29BB-32-32-T	2 - 11	2 - 11

WARNING This product can expose you to chemicals, which are known to the State of California to cause cancer or birth defects or other reproductive harm. For more information visit <https://www.p65warnings.ca.gov/>

IA-BBBB BSPP FEMALE SWIVEL BRANCH TEE

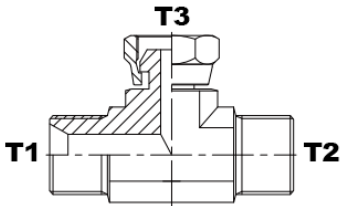
	PART NUMBER	T1	T2	T3
	IA-BBBB-02-02-02	1/8 - 28	1/8 - 28	1/8 - 28
	IA-BBBB-04-04-04	1/4 - 19	1/4 - 19	1/4 - 19
	IA-BBBB-06-06-06	3/8 - 19	3/8 - 19	3/8 - 19
	IA-BBBB-08-08-08	1/2 - 14	1/2 - 14	1/2 - 14
	IA-BBBB-10-10-10	5/8 - 14	5/8 - 14	5/8 - 14
	IA-BBBB-12-12-12	3/4 - 14	3/4 - 14	3/4 - 14
	IA-BBBB-16-16-16	1 - 11	1 - 11	1 - 11
	IA-BBBB-20-20-20	1 1/4 - 11	1 1/4 - 11	1 1/4 - 11

IA-CBBB BSPP FEMALE SWIVEL RUN TEE

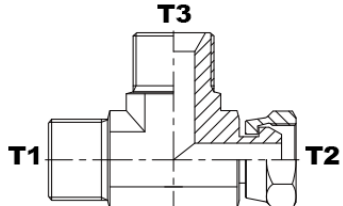
	PART NUMBER	T1	T2	T3
	IA-CBBB-02-02-02	1/8 - 28	1/8 - 28	1/8 - 28
	IA-CBBB-04-04-04	1/4 - 19	1/4 - 19	1/4 - 19
	IA-CBBB-06-06-06	3/8 - 19	3/8 - 19	3/8 - 19
	IA-CBBB-08-08-08	1/2 - 14	1/2 - 14	1/2 - 14
	IA-CBBB-10-10-10	5/8 - 14	5/8 - 14	5/8 - 14
	IA-CBBB-12-12-12	3/4 - 14	3/4 - 14	3/4 - 14
	IA-CBBB-16-16-16	1 - 11	1 - 11	1 - 11
	IA-CBBB-20-20-20	1 1/4 - 11	1 1/4 - 11	1 1/4 - 11
	IA-CBBB-32-32-32	2 - 11	2 - 11	2 - 11

IA-EBBB BSPP MALE BRANCH TEE

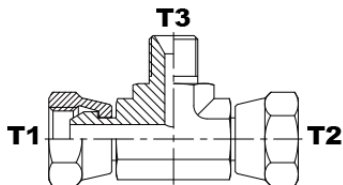
	PART NUMBER	T1	T2	T3
	IA-EBBB-02-02-02	1/8 - 28	1/8 - 28	1/8 - 28
	IA-EBBB-04-04-04	1/4 - 19	1/4 - 19	1/4 - 19
	IA-EBBB-06-06-06	3/8 - 19	3/8 - 19	3/8 - 19
	IA-EBBB-08-08-08	1/2 - 14	1/2 - 14	1/2 - 14
	IA-EBBB-10-10-10	5/8 - 14	5/8 - 14	5/8 - 14
	IA-EBBB-12-12-12	3/4 - 14	3/4 - 14	3/4 - 14
	IA-EBBB-16-16-16	1 - 11	1 - 11	1 - 11
	IA-EBBB-20-20-20	1 1/4 - 11	1 1/4 - 11	1 1/4 - 11
	IA-EBBB-24-24-24	1 1/2 - 11	1 1/2 - 11	1 1/2 - 11
	IA-EBBB-32-32-32	2 - 11	2 - 11	2 - 11

IA-FBBB BSPP MALE RUN TEE

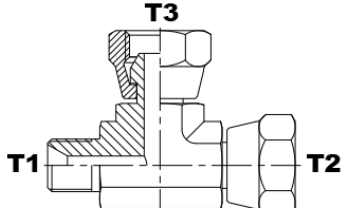
	PART NUMBER	T1	T2	T3
	IA-FBBB-02-02-02	1/8 - 28	1/8 - 28	1/8 - 28
	IA-FBBB-04-04-04	1/4 - 19	1/4 - 19	1/4 - 19
	IA-FBBB-06-06-06	3/8 - 19	3/8 - 19	3/8 - 19
	IA-FBBB-08-08-08	1/2 - 14	1/2 - 14	1/2 - 14
	IA-FBBB-10-10-10	5/8 - 14	5/8 - 14	5/8 - 14
	IA-FBBB-12-12-12	3/4 - 14	3/4 - 14	3/4 - 14
	IA-FBBB-16-16-16	1 - 11	1 - 11	1 - 11

⚠ WARNING This product can expose you to chemicals, which are known to the State of California to cause cancer or birth defects or other reproductive harm. For more information visit <https://www.p65warnings.ca.gov/>

IA-30BB

BSPF FEMALE SWIVEL UNION

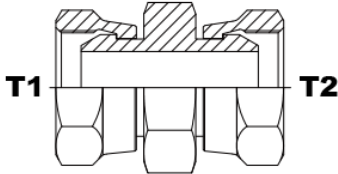
	PART NUMBER	T1	T2
	IA-30BB-02-02	1/8 - 28	1/8 - 28
IA-30BB-04-02	1/4 - 19	1/8 - 28	
IA-30BB-04-04	1/4 - 19	1/4 - 19	
IA-30BB-06-04	3/8 - 19	1/4 - 19	
IA-30BB-06-06	3/8 - 19	3/8 - 19	
IA-30BB-08-04	1/2 - 14	1/4 - 19	
IA-30BB-08-06	1/2 - 14	3/8 - 19	
IA-30BB-08-08	1/2 - 14	1/2 - 14	
IA-30BB-10-08	5/8 - 14	1/2 - 14	
IA-30BB-10-10	5/8 - 14	5/8 - 14	
IA-30BB-12-08	3/4 - 14	1/2 - 14	
IA-30BB-12-10	3/4 - 14	5/8 - 14	
IA-30BB-12-12	3/4 - 14	3/4 - 14	
IA-30BB-16-08	1 - 11	1/2 - 14	
IA-30BB-16-12	1 - 11	3/4 - 14	
IA-30BB-16-16	1 - 11	1 - 11	
IA-30BB-20-16	1 1/4 - 11	1 - 11	
IA-30BB-20-20	1 1/4 - 11	1 1/4 - 11	
IA-30BB-24-24	1 1/2 - 11	1 1/2 - 11	
IA-30BB-32-32	2 - 11	2 - 11	

IA-34BB

45° BSPF FEMALE SWIVEL UNION

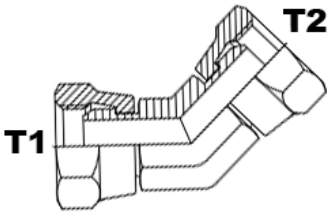
	PART NUMBER	T1	T2
	IA-34BB-04-04	1/4 - 19	1/4 - 19
IA-34BB-06-06	3/8 - 19	3/8 - 19	
IA-34BB-08-08	1/2 - 14	1/2 - 14	
IA-34BB-10-10	5/8 - 14	5/8 - 14	
IA-34BB-12-12	3/4 - 14	3/4 - 14	
IA-34BB-16-16	1 - 11	1 - 11	
IA-34BB-20-20	1 1/4 - 11	1 1/4 - 11	

IA-34BB-T

45° BSPF FEMALE SWIVEL UNION TUBE

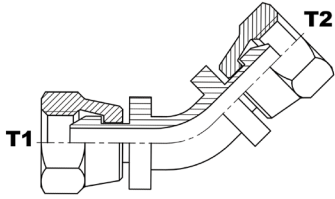
	PART NUMBER	T1	T2
	IA-34BB-04-04-T	1/4 - 19	1/4 - 19
IA-34BB-06-06-T	3/8 - 19	3/8 - 19	
IA-34BB-08-08-T	1/2 - 14	1/2 - 14	
IA-34BB-10-10-T	5/8 - 14	5/8 - 14	
IA-34BB-12-12-T	3/4 - 14	3/4 - 14	
IA-34BB-16-16-T	1 - 11	1 - 11	
IA-34BB-20-20-T	1 1/4 - 11	1 1/4 - 11	

WARNING This product can expose you to chemicals, which are known to the State of California to cause cancer or birth defects or other reproductive harm. For more information visit <https://www.p65warnings.ca.gov/>

IA-39BB 90° BSPP FEMALE SWIVEL UNION

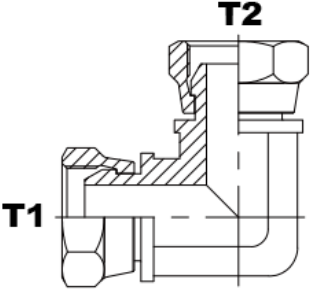
	PART NUMBER	T1	T2
	IA-39BB-02-02	1/8 - 28	1/8 - 28
	IA-39BB-04-04	1/4 - 19	1/4 - 19
	IA-39BB-06-06	3/8 - 19	3/8 - 19
	IA-39BB-08-08	1/2 - 14	1/2 - 14
	IA-39BB-10-10	5/8 - 14	5/8 - 14
	IA-39BB-12-12	3/4 - 14	3/4 - 14
	IA-39BB-16-16	1 - 11	1 - 11
	IA-39BB-20-20	1 1/4 - 11	1 1/4 - 11
	IA-39BB-24-24	1 1/2 - 11	1 1/2 - 11
	IA-39BB-32-32	2 - 11	2 - 11

IA-39BB-T 90° BSPP FEMALE SWIVEL UNION TUBE

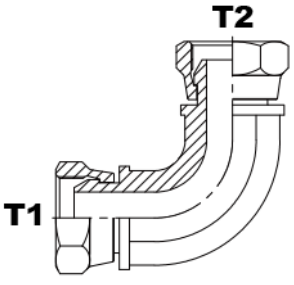
	PART NUMBER	T1	T2
	IA-39BB-04-04-T	1/4 - 19	1/4 - 19
	IA-39BB-06-06-T	3/8 - 19	3/8 - 19
	IA-39BB-08-08-T	1/2 - 14	1/2 - 14
	IA-39BB-10-10-T	5/8 - 14	5/8 - 14
	IA-39BB-12-12-T	3/4 - 14	3/4 - 14
	IA-39BB-16-16-T	1 - 11	1 - 11
	IA-39BB-20-20-T	1 1/4 - 11	1 1/4 - 11
	IA-39BB-24-24-T	1 1/2 - 11	1 1/2 - 11

IA-DBBB BSPP FEMALE SWIVEL UNION TEE

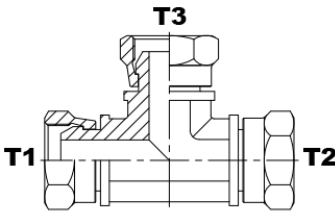
	PART NUMBER	T1	T2	T3
	IA-DBBB-02-02-02	1/8 - 28	1/8 - 28	1/8 - 28
	IA-DBBB-04-04-04	1/4 - 19	1/4 - 19	1/4 - 19
	IA-DBBB-06-06-06	3/8 - 19	3/8 - 19	3/8 - 19
	IA-DBBB-08-08-08	1/2 - 14	1/2 - 14	1/2 - 14
	IA-DBBB-10-10-10	5/8 - 14	5/8 - 14	5/8 - 14
	IA-DBBB-12-12-12	3/4 - 14	3/4 - 14	3/4 - 14
	IA-DBBB-16-16-16	1 - 11	1 - 11	1 - 11
	IA-DBBB-20-20-20	1 1/4 - 11	1 1/4 - 11	1 1/4 - 11
	IA-DBBB-24-24-24	1 1/2 - 11	1 1/2 - 11	1 1/2 - 11

IA-YBBB BSPP FEMALE SWIVEL CROSS

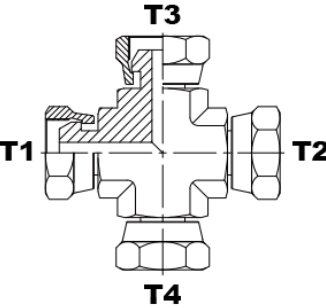
	PART NUMBER	T1	T2	T3	T4
	IA-YBBBB-02-02-02-02	1/8 - 28	1/8 - 28	1/8 - 28	1/8 - 28
	IA-YBBBB-04-04-04-04	1/4 - 19	1/4 - 19	1/4 - 19	1/4 - 19
	IA-YBBBB-06-06-06-06	3/8 - 19	3/8 - 19	3/8 - 19	3/8 - 19
	IA-YBBBB-08-08-08-08	1/2 - 14	1/2 - 14	1/2 - 14	1/2 - 14
	IA-YBBBB-10-10-10-10	5/8 - 14	5/8 - 14	5/8 - 14	5/8 - 14
	IA-YBBBB-12-12-12-12	3/4 - 14	3/4 - 14	3/4 - 14	3/4 - 14
	IA-YBBBB-16-16-16-16	1 - 11	1 - 11	1 - 11	1 - 11

WARNING This product can expose you to chemicals, which are known to the State of California to cause cancer or birth defects or other reproductive harm. For more information visit <https://www.p65warnings.ca.gov/>

IA-50BB

BSPP MALE x FEMALE RIGID

	PART NUMBER	T1	T2
	IA-50BB-02-02	1/8 - 28	1/8 - 28
	IA-50BB-02-04	1/8 - 28	1/4 - 19
	IA-50BB-02-06	1/8 - 28	3/8 - 19
	IA-50BB-02-08	1/8 - 28	1/2 - 14
	IA-50BB-04-02	1/4 - 19	1/8 - 28
	IA-50BB-04-04	1/4 - 19	1/4 - 19
	IA-50BB-04-06	1/4 - 19	3/8 - 19
	IA-50BB-04-08	1/4 - 19	1/2 - 14
	IA-50BB-04-12	1/4 - 19	3/4 - 14
	IA-50BB-06-02	3/8 - 19	1/8 - 28
	IA-50BB-06-04	3/8 - 19	1/4 - 19
	IA-50BB-06-06	3/8 - 19	3/8 - 19
	IA-50BB-06-08	3/8 - 19	1/2 - 14
	IA-50BB-06-12	3/8 - 19	3/4 - 14
	IA-50BB-06-16	3/8 - 19	1 - 11
	IA-50BB-08-02	1/2 - 14	1/8 - 28
	IA-50BB-08-04	1/2 - 14	1/4 - 19
	IA-50BB-08-06	1/2 - 14	3/8 - 19
	IA-50BB-08-08	1/2 - 14	1/2 - 14
	IA-50BB-08-12	1/2 - 14	3/4 - 14
	IA-50BB-08-16	1/2 - 14	1 - 11
	IA-50BB-08-20	1/2 - 14	1 1/4 - 11
	IA-50BB-10-08	5/8 - 14	1/2 - 14
	IA-50BB-10-12	5/8 - 14	3/4 - 14
	IA-50BB-12-04	3/4 - 14	1/4 - 19
	IA-50BB-12-06	3/4 - 14	3/8 - 19
	IA-50BB-12-08	3/4 - 14	1/2 - 14
	IA-50BB-12-10	3/4 - 14	5/8 - 14
	IA-50BB-12-12	3/4 - 14	3/4 - 14
	IA-50BB-12-16	3/4 - 14	1 - 11
	IA-50BB-12-20	3/4 - 14	1 1/4 - 11
	IA-50BB-12-24	3/4 - 14	1 1/2 - 11
	IA-50BB-16-04	1 - 11	1/4 - 19
	IA-50BB-16-06	1 - 11	3/8 - 19
	IA-50BB-16-08	1 - 11	1/2 - 14
	IA-50BB-16-12	1 - 11	3/4 - 14
	IA-50BB-16-16	1 - 11	1 - 11
	IA-50BB-16-20	1 - 11	1 1/4 - 11
	IA-50BB-16-24	1 - 11	1 1/2 - 11
	IA-50BB-16-32	1 - 11	2 - 11
	IA-50BB-16-48	1 - 11	3 - 11
	IA-50BB-20-08	1 1/4 - 11	1/2 - 14
	IA-50BB-20-12	1 1/4 - 11	3/4 - 14
	IA-50BB-20-16	1 1/4 - 11	1 - 11
	IA-50BB-20-20	1 1/4 - 11	1 1/4 - 11
	IA-50BB-20-24	1 1/4 - 11	1 1/2 - 11
	IA-50BB-20-32	1 1/4 - 11	2 - 11
	IA-50BB-24-08	1 1/2 - 11	1/2 - 14
	IA-50BB-24-12	1 1/2 - 11	3/4 - 14
	IA-50BB-24-16	1 1/2 - 11	1 - 11
	IA-50BB-24-20	1 1/2 - 11	1 1/4 - 11
	IA-50BB-24-24	1 1/2 - 11	1 1/2 - 11
	IA-50BB-24-32	1 1/2 - 11	2 - 11
	IA-50BB-32-04	2 - 11	1/4 - 19
	IA-50BB-32-06	2 - 11	3/8 - 19

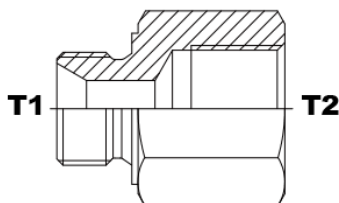

WARNING This product can expose you to chemicals, which are known to the State of California to cause cancer or birth defects or other reproductive harm. For more information visit <https://www.p65warnings.ca.gov/>

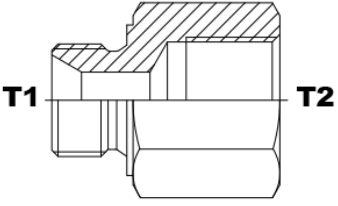

IA-50BB BSPP MALE x FEMALE RIGID

	PART NUMBER	T1	T2
	IA-50BB-32-08	2 - 11	1/2 - 14
IA-50BB-32-12	2 - 11	3/4 - 14	
IA-50BB-32-16	2 - 11	1 - 11	
IA-50BB-32-20	2 - 11	1 1/4 - 11	
IA-50BB-32-24	2 - 11	1 1/2 - 11	
IA-50BB-32-32	2 - 11	2 - 11	
IA-50BB-32-40	2 - 11	2 1/2 - 11	
IA-50BB-40-24	2 1/2 - 11	1 1/2 - 11	
IA-50BB-40-32	2 1/2 - 11	2 - 11	
IA-50BB-40-40	2 1/2 - 11	2 1/2 - 11	
IA-50BB-48-24	3 - 11	1 1/2 - 11	
IA-50BB-48-32	3 - 11	2 - 11	
IA-50BB-64-48	4 - 11	3 - 11	

IA-50BB-WD BSPP MALE x FEMALE RIGID + CAPTIVE SEAL

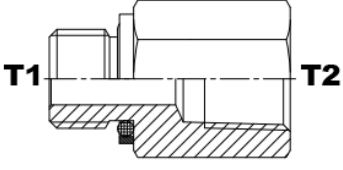
	PART NUMBER	T1	T2
	IA-50BB-02-04-WD	1/8 - 28	1/4 - 19
IA-50BB-02-06-WD	1/8 - 28	3/8 - 19	
IA-50BB-04-02-WD	1/4 - 19	1/8 - 28	
IA-50BB-04-06-WD	1/4 - 19	3/8 - 19	
IA-50BB-04-08-WD	1/4 - 19	1/2 - 14	
IA-50BB-06-02-WD	3/8 - 19	1/8 - 28	
IA-50BB-06-04-WD	3/8 - 19	1/4 - 19	
IA-50BB-06-08-WD	3/8 - 19	1/2 - 14	
IA-50BB-08-02-WD	1/2 - 14	1/8 - 28	
IA-50BB-08-04-WD	1/2 - 14	1/4 - 19	
IA-50BB-08-06-WD	1/2 - 14	3/8 - 19	
IA-50BB-08-12-WD	1/2 - 14	3/4 - 14	
IA-50BB-08-16-WD	1/2 - 14	1 - 11	
IA-50BB-08-20-WD	1/2 - 14	1 1/4 - 11	
IA-50BB-12-04-WD	3/4 - 14	1/4 - 19	
IA-50BB-12-06-WD	3/4 - 14	3/8 - 19	
IA-50BB-12-08-WD	3/4 - 14	1/2 - 14	
IA-50BB-12-16-WD	3/4 - 14	1 - 11	
IA-50BB-16-08-WD	1 - 11	1/2 - 14	
IA-50BB-16-12-WD	1 - 11	3/4 - 14	
IA-50BB-20-12-WD	1 1/4 - 11	3/4 - 14	
IA-50BB-20-16-WD	1 1/4 - 11	1 - 11	
IA-50BB-24-12-WD	1 1/2 - 11	3/4 - 14	
IA-50BB-24-16-WD	1 1/2 - 11	1 - 11	

⚠ WARNING This product can expose you to chemicals, which are known to the State of California to cause cancer or birth defects or other reproductive harm. For more information visit <https://www.p65warnings.ca.gov/>

IA-50BB-SB-WD

M-BSP CAPTIVE SEAL x F-BSP - SHORT BODY

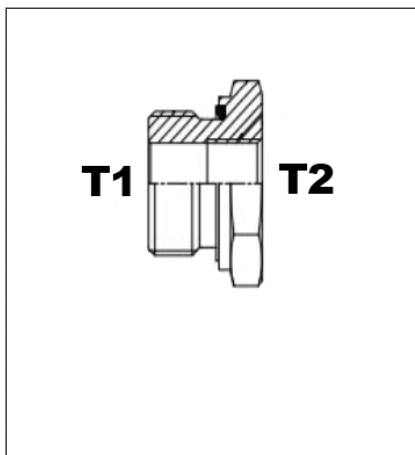

PART NUMBER	T1	T2
IA-50BB-06-02-SB-WD	3/8 - 19	1/8 - 28
IA-50BB-08-02-SB-WD	1/2 - 14	1/8 - 28
IA-50BB-08-04-SB-WD	1/2 - 14	1/4 - 19
IA-50BB-12-04-SB-WD	3/4 - 14	1/4 - 19
IA-50BB-12-06-SB-WD	3/4 - 14	3/8 - 19
IA-50BB-16-04-SB-WD	1 - 11	1/4 - 19
IA-50BB-16-06-SB-WD	1 - 11	3/8 - 19
IA-50BB-16-08-SB-WD	1 - 11	1/2 - 14
IA-50BB-20-08-SB-WD	1 1/4 - 11	1/2 - 14
IA-50BB-20-12-SB-WD	1 1/4 - 11	3/4 - 14
IA-50BB-24-08-SB-WD	1 1/2 - 11	1/2 - 14
IA-50BB-24-12-SB-WD	1 1/2 - 11	3/4 - 14
IA-50BB-24-16-SB-WD	1 1/2 - 11	1 - 11

IA-59BB

BSP MALE x 90° FEMALE RIGID

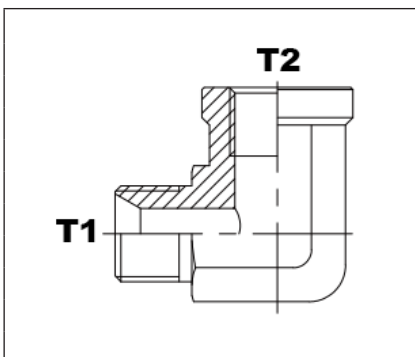

PART NUMBER	T1	T2
IA-59BB-04-04	1/4 - 19	1/4 - 19
IA-59BB-06-06	3/8 - 19	3/8 - 19
IA-59BB-08-08	1/2 - 14	1/2 - 14
IA-59BB-12-12	3/4 - 14	3/4 - 14

IA-70BB

BSP FEMALE RIGID COUPLING

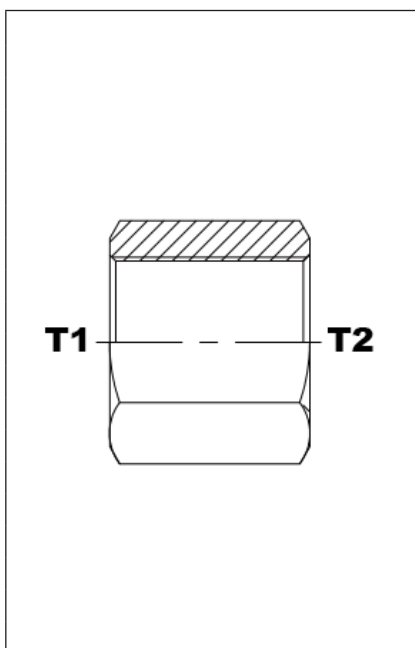

PART NUMBER	T1	T2
IA-70BB-02-02	1/8 - 28	1/8 - 28
IA-70BB-04-02	1/4 - 19	1/8 - 28
IA-70BB-04-04	1/4 - 19	1/4 - 19
IA-70BB-06-04	3/8 - 19	1/4 - 19
IA-70BB-06-06	3/8 - 19	3/8 - 19
IA-70BB-08-04	1/2 - 14	1/4 - 19
IA-70BB-08-06	1/2 - 14	3/8 - 19
IA-70BB-08-08	1/2 - 14	1/2 - 14
IA-70BB-10-08	5/8 - 14	1/2 - 14
IA-70BB-10-10	5/8 - 14	5/8 - 14
IA-70BB-12-06	3/4 - 14	3/8 - 19
IA-70BB-12-08	3/4 - 14	1/2 - 14
IA-70BB-12-12	3/4 - 14	3/4 - 14
IA-70BB-16-12	1 - 11	3/4 - 14
IA-70BB-16-16	1 - 11	1 - 11
IA-70BB-20-16	1 1/4 - 11	1 - 11
IA-70BB-20-20	1 1/4 - 11	1 1/4 - 11
IA-70BB-24-24	1 1/2 - 11	1 1/2 - 11
IA-70BB-32-32	2 - 11	2 - 11

WARNING This product can expose you to chemicals, which are known to the State of California to cause cancer or birth defects or other reproductive harm. For more information visit <https://www.p65warnings.ca.gov/>

IA-74BB 45° BSPP FEMALE RIGID COUPLING

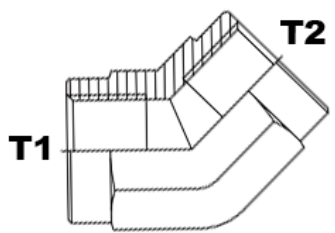
	PART NUMBER	T1	T2
	IA-74BB-02-02	1/8 - 28	1/8 - 28
	IA-74BB-04-04	1/4 - 19	1/4 - 19
	IA-74BB-06-06	3/8 - 19	3/8 - 19
	IA-74BB-08-08	1/2 - 14	1/2 - 14
	IA-74BB-10-10	5/8 - 14	5/8 - 14
	IA-74BB-12-12	3/4 - 14	3/4 - 14
	IA-74BB-16-16	1 - 11	1 - 11
	IA-74BB-20-20	1 1/4 - 11	1 1/4 - 11
	IA-74BB-24-24	1 1/2 - 11	1 1/2 - 11
	IA-74BB-32-32	2 - 11	2 - 11

IA-79BB 90° BSPP FEMALE RIGID COUPLING

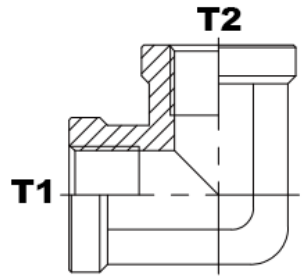
	PART NUMBER	T1	T2
	IA-79BB-02-02	1/8 - 28	1/8 - 28
	IA-79BB-04-04	1/4 - 19	1/4 - 19
	IA-79BB-06-06	3/8 - 19	3/8 - 19
	IA-79BB-08-08	1/2 - 14	1/2 - 14
	IA-79BB-12-12	3/4 - 14	3/4 - 14
	IA-79BB-16-16	1 - 11	1 - 11

IA-GBBB BSPP FEMALE RIGID UNION TEE

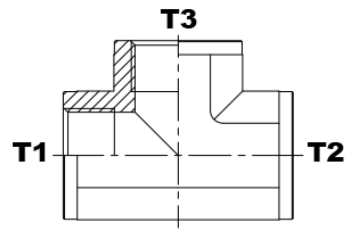
	PART NUMBER	T1	T2	T3
	IA-GBBB-02-02-02	1/8 - 28	1/8 - 28	1/8 - 28
	IA-GBBB-04-04-04	1/4 - 19	1/4 - 19	1/4 - 19
	IA-GBBB-06-06-06	3/8 - 19	3/8 - 19	3/8 - 19
	IA-GBBB-08-08-08	1/2 - 14	1/2 - 14	1/2 - 14
	IA-GBBB-12-12-12	3/4 - 14	3/4 - 14	3/4 - 14
	IA-GBBB-16-16-16	1 - 11	1 - 11	1 - 11

IA-40BB BSPP FEMALE RIGID x BSPP FEMALE SWIVEL

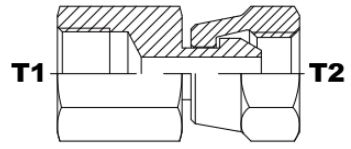
	PART NUMBER	T1	T2
	IA-40BB-04-04	1/4 - 19	1/4 - 19
	IA-40BB-06-06	3/8 - 19	3/8 - 19

*Quoted Upon Request

⚠ WARNING This product can expose you to chemicals, which are known to the State of California to cause cancer or birth defects or other reproductive harm. For more information visit <https://www.p65warnings.ca.gov/>

IA-60BB BSPP MALE BULKHEAD UNION

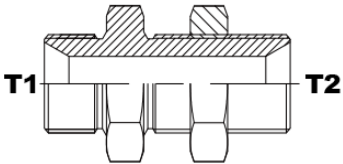
	PART NUMBER	T1	T2
	IA-60BB-02-02-LN	1/8 - 28	1/8 - 28
IA-60BB-04-04-LN	1/4 - 19	1/4 - 19	
IA-60BB-04-06-LN	1/4 - 19	3/8 - 19	
IA-60BB-06-04-LN	3/8 - 19	1/4 - 19	
IA-60BB-06-06-LN	3/8 - 19	3/8 - 19	
IA-60BB-06-08-LN	3/8 - 19	1/2 - 14	
IA-60BB-08-06-LN	1/2 - 14	3/8 - 19	
IA-60BB-08-08-LN	1/2 - 14	1/2 - 14	
IA-60BB-08-12-LN	1/2 - 14	3/4 - 14	
IA-60BB-10-10-LN	5/8 - 14	5/8 - 14	
IA-60BB-12-08-LN	3/4 - 14	1/2 - 14	
IA-60BB-12-12-LN	3/4 - 14	3/4 - 14	
IA-60BB-16-16-LN	1 - 11	1 - 11	
IA-60BB-20-20-LN	1 1/4 - 11	1 1/4 - 11	
IA-60BB-24-24-LN	1 1/2 - 11	1 1/2 - 11	
IA-60BB-32-32-LN	2 - 11	2 - 11	

IA-69BB 90° BSPP MALE BULKHEAD UNION

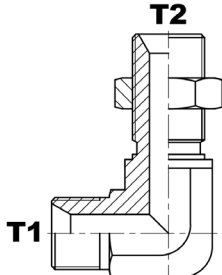
	PART NUMBER	T1	T2
	IA-69BB-02-02-LN	1/8 - 28	1/8 - 28
IA-69BB-04-04-LN	1/4 - 19	1/4 - 19	
IA-69BB-04-06-LN	1/4 - 19	3/8 - 19	
IA-69BB-06-06-LN	3/8 - 19	3/8 - 19	
IA-69BB-06-08-LN	3/8 - 19	1/2 - 14	
IA-69BB-08-06-LN	1/2 - 14	3/8 - 19	
IA-69BB-08-08-LN	1/2 - 14	1/2 - 14	
IA-69BB-10-10-LN	5/8 - 14	5/8 - 14	
IA-69BB-12-08-LN	3/4 - 14	1/2 - 14	
IA-69BB-12-12-LN	3/4 - 14	3/4 - 14	
IA-69BB-16-16-LN	1 - 11	1 - 11	
IA-69BB-20-20-LN	1 1/4 - 11	1 1/4 - 11	

IA-0LNB BSPP MALE BULKHEAD LOCKNUT

	PART NUMBER	T1
	IA-0LNB-02	1/8 - 28
IA-0LNB-04	1/4 - 19	
IA-0LNB-06	3/8 - 19	
IA-0LNB-08	1/2 - 14	
IA-0LNB-10	5/8 - 14	
IA-0LNB-12	3/4 - 14	
IA-0LNB-16	1 - 11	
IA-0LNB-20	1 1/4 - 11	
IA-0LNB-24	1 1/2 - 11	
IA-0LNB-32	2 - 11	

WARNING This product can expose you to chemicals, which are known to the State of California to cause cancer or birth defects or other reproductive harm. For more information visit <https://www.p65warnings.ca.gov/>



IA-10BN BSPP MALE x NPT MALE

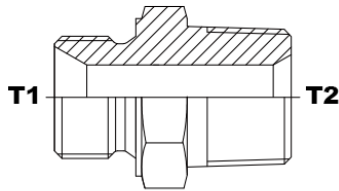

PART NUMBER	T1	T2
IA-10BN-02-02	1/8 - 28	1/8 - 27
IA-10BN-02-04	1/8 - 28	1/4 - 18
IA-10BN-04-02	1/4 - 19	1/8 - 27
IA-10BN-04-04	1/4 - 19	1/4 - 18
IA-10BN-04-06	1/4 - 19	3/8 - 18
IA-10BN-04-08	1/4 - 19	1/2 - 14
IA-10BN-06-02	3/8 - 19	1/8 - 27
IA-10BN-06-04	3/8 - 19	1/4 - 18
IA-10BN-06-06	3/8 - 19	3/8 - 18
IA-10BN-06-08	3/8 - 19	1/2 - 14
IA-10BN-06-12	3/8 - 19	3/4 - 14
IA-10BN-06-16	3/8 - 19	1 - 11 1/2
IA-10BN-08-04	1/2 - 14	1/4 - 18
IA-10BN-08-06	1/2 - 14	3/8 - 18
IA-10BN-08-08	1/2 - 14	1/2 - 14
IA-10BN-08-12	1/2 - 14	3/4 - 14
IA-10BN-08-16	1/2 - 14	1 - 11 1/2
IA-10BN-10-08	1/2 - 14	1/2 - 14
IA-10BN-10-12	5/8 - 14	3/4 - 14
IA-10BN-12-04	3/4 - 14	1/4 - 18
IA-10BN-12-06	3/4 - 14	3/8 - 18
IA-10BN-12-08	3/4 - 14	1/2 - 14
IA-10BN-12-12	3/4 - 14	3/4 - 14
IA-10BN-12-16	3/4 - 14	1 - 11 1/2
IA-10BN-12-20	3/4 - 14	1 1/4 - 11 1/2
IA-10BN-16-08	1 - 11	1/2 - 14
IA-10BN-16-12	1 - 11	3/4 - 14
IA-10BN-16-16	1 - 11	1 - 11 1/2
IA-10BN-16-20	1 - 11	1 1/4 - 11 1/2
IA-10BN-16-24	1 - 11	1 1/2 - 11 1/2
IA-10BN-20-12	1 1/4 - 11	3/4 - 14
IA-10BN-20-16	1 1/4 - 11	1 - 11 1/2
IA-10BN-20-20	1 1/4 - 11	1 1/4 - 11 1/2
IA-10BN-20-24	1 1/4 - 11	1 1/2 - 11 1/2
IA-10BN-24-12	1 1/2 - 11	3/4 - 14
IA-10BN-24-16	1 1/2 - 11	1 - 11 1/2
IA-10BN-24-20	1 1/2 - 11	1 1/4 - 11 1/2
IA-10BN-24-24	1 1/2 - 11	1 1/2 - 11 1/2
IA-10BN-24-32	1 1/2 - 11	2 - 11 1/2
IA-10BN-32-20	2 - 11	1 1/4 - 11 1/2
IA-10BN-32-24	2 - 11	1 1/2 - 11 1/2
IA-10BN-32-32	2 - 11	2 - 11 1/2
IA-10BN-32-40	2 - 11	2 1/2 - 8
IA-10BN-32-48	2 - 11	3 - 8
IA-10BN-40-32	2 1/2 - 11	2 - 11 1/2
IA-10BN-40-40	2 1/2 - 11	2 1/2 - 8
IA-10BN-40-48	2 1/2 - 11	3 - 8
IA-10BN-48-48	3 - 11	3 - 8
IA-10BN-64-64	4 - 11	4 - 8

WARNING This product can expose you to chemicals, which are known to the State of California to cause cancer or birth defects or other reproductive harm. For more information visit <https://www.p65warnings.ca.gov/>

IA-14BN BSPP MALE x 45° NPT MALE

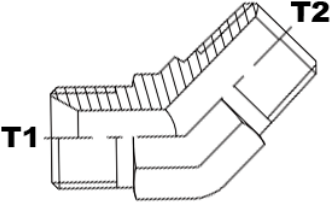
	PART NUMBER	T1	T2
	IA-14BN-04-04	1/4 - 19	1/4 - 18
	IA-14BN-06-06	3/8 - 19	3/8 - 18

*Quoted Upon Request

IA-19BN BSPP MALE x 90° NPT MALE

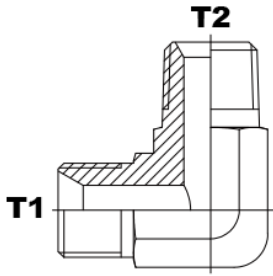
	PART NUMBER	T1	T2
	IA-19BN-02-02	1/8 - 28	1/8 - 27
	IA-19BN-04-02	1/4 - 19	1/8 - 27
IA-19BN-04-04	1/4 - 19	1/4 - 18	
IA-19BN-06-04	3/8 - 19	1/4 - 18	
IA-19BN-06-06	3/8 - 19	3/8 - 18	
IA-19BN-06-08	3/8 - 19	1/2 - 14	
IA-19BN-08-06	1/2 - 14	3/8 - 18	
IA-19BN-08-08	1/2 - 14	1/2 - 14	
IA-19BN-12-12	3/4 - 14	3/4 - 14	
IA-19BN-16-16	1 - 11	1 - 11 1/2	

IA-20NB NPT MALE x BSPP FEMALE SWIVEL

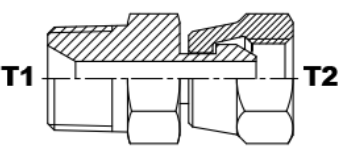
	PART NUMBER	T1	T2
	IA-20NB-02-02	1/8 - 27	1/8 - 28
	IA-20NB-02-04	1/8 - 27	1/4 - 19
IA-20NB-04-04	1/4 - 18	1/4 - 19	
IA-20NB-04-06	1/4 - 18	3/8 - 19	
IA-20NB-06-04	3/8 - 18	1/4 - 19	
IA-20NB-06-06	3/8 - 18	3/8 - 19	
IA-20NB-06-08	3/8 - 18	1/2 - 14	
IA-20NB-08-06	1/2 - 14	3/8 - 19	
IA-20NB-08-08	1/2 - 14	1/2 - 14	
IA-20NB-08-12	1/2 - 14	3/4 - 14	
IA-20NB-12-08	3/4 - 14	1/2 - 14	
IA-20NB-12-12	3/4 - 14	3/4 - 14	
IA-20NB-16-12	1 - 11 1/2	3/4 - 14	
IA-20NB-16-16	1 - 11 1/2	1 - 11	
IA-20NB-20-20	1 1/4 - 11 1/2	1 1/4 - 11	
IA-20NB-24-24	1 1/2 - 11 1/2	1 1/2 - 11	

WARNING This product can expose you to chemicals, which are known to the State of California to cause cancer or birth defects or other reproductive harm. For more information visit <https://www.p65warnings.ca.gov/>

IA-50BN

BSPP MALE x NPT FEMALE RIGID

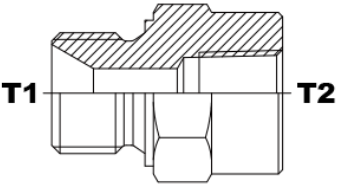
	PART NUMBER		
	T1	T2	
	IA-50BN-02-02	1/8 - 28	1/8 - 27
	IA-50BN-02-04	1/8 - 28	1/4 - 18
	IA-50BN-04-02	1/4 - 19	1/8 - 27
	IA-50BN-04-04	1/4 - 19	1/4 - 18
	IA-50BN-04-06	1/4 - 19	3/8 - 18
	IA-50BN-06-02	3/8 - 19	1/8 - 27
	IA-50BN-06-04	3/8 - 19	1/4 - 18
	IA-50BN-06-06	3/8 - 19	3/8 - 18
	IA-50BN-06-08	3/8 - 19	1/2 - 14
	IA-50BN-08-04	1/2 - 14	1/4 - 18
	IA-50BN-08-06	1/2 - 14	3/8 - 18
	IA-50BN-08-08	1/2 - 14	1/2 - 14
	IA-50BN-08-12	1/2 - 14	3/4 - 14
	IA-50BN-12-08	3/4 - 14	1/2 - 14
	IA-50BN-12-12	3/4 - 14	3/4 - 14
	IA-50BN-16-08	1 - 11	1/2 - 14
	IA-50BN-16-12	1 - 11	3/4 - 14
	IA-50BN-16-16	1 - 11	1 - 11 1/2
	IA-50BN-20-12	1 1/4 - 11	3/4 - 14
	IA-50BN-20-16	1 1/4 - 11	1 - 11 1/2
IA-50BN-20-20	1 1/4 - 11	1 1/4 - 11 1/2	
IA-50BN-24-20	1 1/2 - 11	1 1/4 - 11 1/2	
IA-50BN-24-24	1 1/2 - 11	1 1/2 - 11 1/2	
IA-50BN-32-32	2 - 11	2 - 11 1/2	

IA-70BN

BSPP FEMALE x NPT FEMALE RIGID

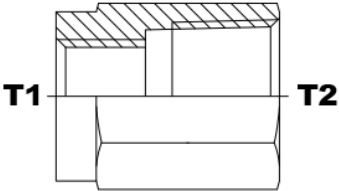
	PART NUMBER		
	T1	T2	
	IA-70BN-04-04	1/4 - 19	1/4 - 18
	IA-70BN-06-06	3/8 - 19	3/8 - 18
	IA-70BN-08-08	1/2 - 14	1/2 - 14
	IA-70BN-12-12	3/4 - 14	3/4 - 14
	IA-70BN-16-16	1 - 11	1 - 11 1/2
	IA-70BN-20-20	1 1/4 - 11	1 1/4 - 11 1/2

WARNING This product can expose you to chemicals, which are known to the State of California to cause cancer or birth defects or other reproductive harm. For more information visit <https://www.p65warnings.ca.gov/>





IA-10BO BSPP MALE x M-ORB

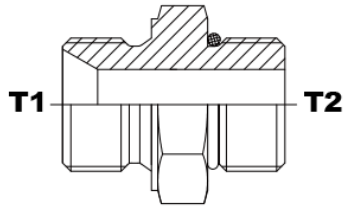

PART NUMBER	T1	T2
IA-10BO-04-04	1/4 - 19	7/16 - 20
IA-10BO-04-05	1/4 - 19	1/2 - 20
IA-10BO-04-06	1/4 - 19	9/16 - 18
IA-10BO-04-08	1/4 - 19	3/4 - 16
IA-10BO-06-04	3/8 - 19	7/16 - 20
IA-10BO-06-06	3/8 - 19	9/16 - 18
IA-10BO-06-08	3/8 - 19	3/4 - 16
IA-10BO-06-10	3/8 - 19	7/8 - 14
IA-10BO-08-04	1/2 - 14	7/16 - 20
IA-10BO-08-06	1/2 - 14	9/16 - 18
IA-10BO-08-08	1/2 - 14	3/4 - 16
IA-10BO-08-10	1/2 - 14	7/8 - 14
IA-10BO-08-12	1/2 - 14	1 1/16 - 12
IA-10BO-10-08	5/8 - 14	3/4 - 16
IA-10BO-10-10	5/8 - 14	7/8 - 14
IA-10BO-10-12	5/8 - 14	1 1/16 - 12
IA-10BO-12-08	3/4 - 14	3/4 - 16
IA-10BO-12-10	3/4 - 14	7/8 - 14
IA-10BO-12-12	3/4 - 14	1 1/16 - 12
IA-10BO-12-16	3/4 - 14	1 5/16 - 12
IA-10BO-16-12	1 - 11	1 1/16 - 12
IA-10BO-16-16	1 - 11	1 5/16 - 12
IA-10BO-16-20	1 - 11	1 5/8 - 12
IA-10BO-20-16	1 1/4 - 11	1 5/16 - 12
IA-10BO-20-20	1 1/4 - 11	1 5/8 - 12
IA-10BO-24-24	1 1/2 - 11	1 7/8 - 12

IA-14BO BSPP MALE x 45° M-ORB

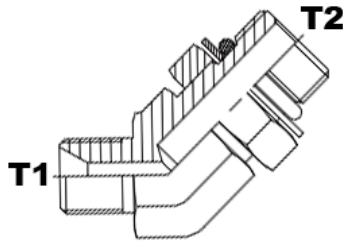

PART NUMBER	T1	T2
IA-14BO-04-04	1/4 - 19	7/16 - 20
IA-14BO-06-06	3/8 - 19	9/16 - 18
IA-14BO-08-08	1/2 - 14	3/4 - 16
IA-14BO-08-10	1/2 - 14	7/8 - 14
IA-14BO-12-12	3/4 - 14	1 1/16 - 12
IA-14BO-16-16	1 - 11	1 5/16 - 12

IA-19BO BSPP MALE x 90° M-ORB

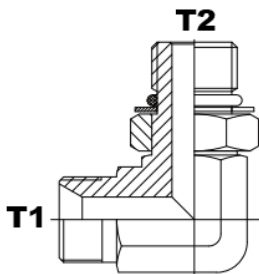

PART NUMBER	T1	T2
IA-19BO-04-04	1/4 - 19	7/16 - 20
IA-19BO-04-06	1/4 - 19	9/16 - 18
IA-19BO-06-06	3/8 - 19	9/16 - 18
IA-19BO-06-08	3/8 - 19	3/4 - 16
IA-19BO-08-08	1/2 - 14	3/4 - 16
IA-19BO-08-10	1/2 - 14	7/8 - 14
IA-19BO-10-10	5/8 - 14	7/8 - 14
IA-19BO-12-12	3/4 - 14	1 1/16 - 12
IA-19BO-16-16	1 - 11	1 5/16 - 12

WARNING This product can expose you to chemicals, which are known to the State of California to cause cancer or birth defects or other reproductive harm. For more information visit <https://www.p65warnings.ca.gov/>

IA-50BO M-BSP x ORB FEMALE

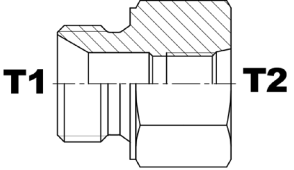
	PART NUMBER	T1	T2
	IA-50BO-04-04	1/4 - 19	7/16 - 20
	IA-50BO-06-04	3/8 - 19	7/16 - 20
	IA-50BO-06-06	3/8 - 19	9/16 - 18
	IA-50BO-08-08	1/2 - 14	3/4 - 16
	IA-50BO-08-10	1/2 - 14	7/8 - 14
	IA-50BO-12-12	3/4 - 14	1 1/16 - 12
	IA-50BO-16-16	1 - 11	1 5/16 - 12
	IA-50BO-20-20	1 1/4 - 11	1 5/8 - 12

IA-ABBO BSPP MALE x M-ORB BR TEE

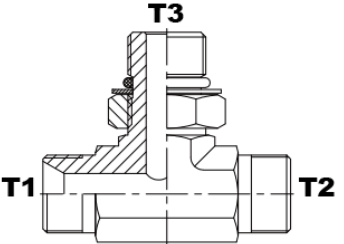
	PART NUMBER	T1	T2	T3
	IA-ABBO-04-04-04	1/4 - 19	1/4 - 19	7/16 - 20
	IA-ABBO-06-06-06	3/8 - 19	3/8 - 19	9/16 - 18
	IA-ABBO-08-08-08	1/2 - 14	1/2 - 14	3/4 - 16
	IA-ABBO-12-12-12	3/4 - 14	3/4 - 14	1 1/16 - 12
	IA-ABBO-16-16-16	1 - 11	1 - 11	1 5/16 - 12

IA-ABOB BSPP MALE x M-ORB RUN TEE

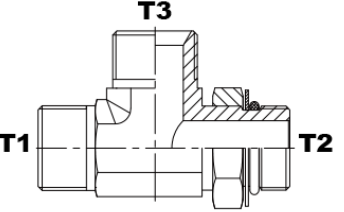
	PART NUMBER	T1	T2	T3
	IA-ABOB-04-04-04	1/4 - 19	7/16 - 20	1/4 - 19
	IA-ABOB-06-06-06	3/8 - 19	9/16 - 18	3/8 - 19
	IA-ABOB-08-08-08	1/2 - 14	3/4 - 16	1/2 - 14
	IA-ABOB-12-12-12	3/4 - 14	1 1/16 - 12	3/4 - 14
	IA-ABOB-16-16-16	1 - 11	1 5/16 - 12	1 - 11

IA-20OB M-ORB x BSPP FEMALE SWIVEL

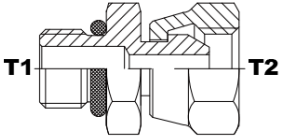
	PART NUMBER	T1	T2
	IA-20OB-04-04	7/16 - 20	1/4 - 19
	IA-20OB-06-04	9/16 - 18	1/4 - 19
	IA-20OB-06-06	9/16 - 18	3/8 - 19
	IA-20OB-06-08	9/16 - 18	1/2 - 14
	IA-20OB-08-06	3/4 - 16	3/8 - 19
	IA-20OB-08-08	3/4 - 16	1/2 - 14
	IA-20OB-08-12	3/4 - 16	3/4 - 14
	IA-20OB-10-08	7/8 - 14	1/2 - 14
	IA-20OB-12-08	1 1/16 - 12	1/2 - 14
	IA-20OB-12-12	1 1/16 - 12	3/4 - 14
	IA-20OB-16-16	1 5/16 - 12	1 - 11

WARNING This product can expose you to chemicals, which are known to the State of California to cause cancer or birth defects or other reproductive harm. For more information visit <https://www.p65warnings.ca.gov/>





IA-24OB M-ORB x BSPP FEMALE SWIVEL 45°

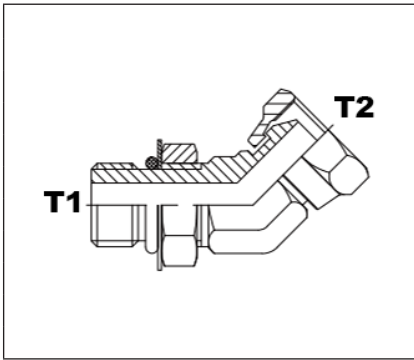

PART NUMBER	T1	T2
IA-24OB-04-04	7/16 - 20	1/4 - 19
IA-24OB-04-06	7/16 - 20	3/8 - 19
IA-24OB-06-04	9/16 - 18	1/4 - 19
IA-24OB-06-06	9/16 - 18	3/8 - 19
IA-24OB-08-06	3/4 - 16	3/8 - 19
IA-24OB-08-08	3/4 - 16	1/2 - 14
IA-24OB-08-12	3/4 - 16	3/4 - 14
IA-24OB-10-08	7/8 - 14	1/2 - 14
IA-24OB-12-12	1 1/16 - 12	3/4 - 14

IA-29OB M-ORB x BSPP FEMALE SWIVEL 90°

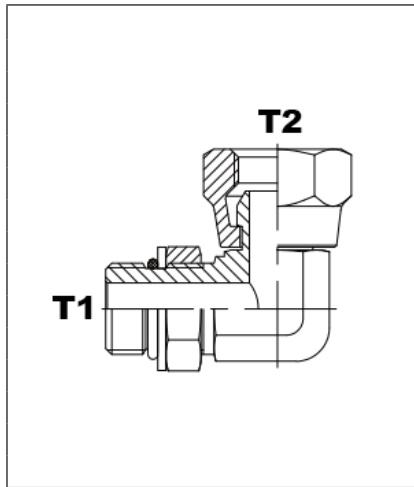

PART NUMBER	T1	T2
IA-29OB-04-04	7/16 - 20	1/4 - 19
IA-29OB-06-04	7/16 - 20	1/4 - 19
IA-29OB-06-06	9/16 - 18	3/8 - 19
IA-29OB-06-08	3/4 - 16	1/2 - 14
IA-29OB-08-06	9/16 - 18	3/8 - 19
IA-29OB-08-08	3/4 - 16	1/2 - 14
IA-29OB-08-10	7/8 - 14	5/8 - 14
IA-29OB-08-12	1 1/16 - 12	3/4 - 14
IA-29OB-10-08	3/4 - 16	1/2 - 14
IA-29OB-12-08	3/4 - 16	1/2 - 14
IA-29OB-12-12	1 1/16 - 12	3/4 - 14
IA-29OB-16-16	1 5/16 - 12	1 - 11
IA-29OB-20-20	1 5/8 - 12	1 1/4 - 11
IA-29OB-24-24	1 7/8 - 12	1 1/2 - 11

IA-50OB M-ORB x BSPP FEMALE RIGID

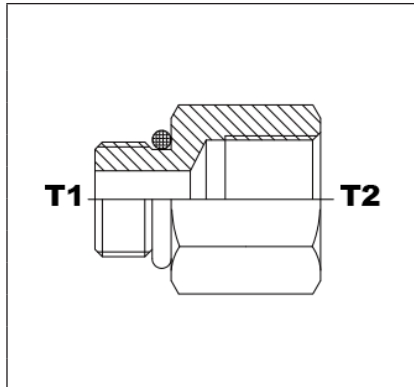

PART NUMBER	T1	T2
IA-50OB-04-04	7/16 - 20	1/4 - 19
IA-50OB-06-06	9/16 - 18	3/8 - 19
IA-50OB-08-06	9/16 - 18	3/8 - 19
IA-50OB-08-08	3/4 - 16	1/2 - 14
IA-50OB-10-08	3/4 - 16	1/2 - 14
IA-50OB-12-12	1 1/16 - 12	3/4 - 14
IA-50OB-16-16	1 5/16 - 12	1 - 11

WARNING This product can expose you to chemicals, which are known to the State of California to cause cancer or birth defects or other reproductive harm. For more information visit <https://www.p65warnings.ca.gov/>

IA-10JB

JIC MALE x BSPP MALE 60°

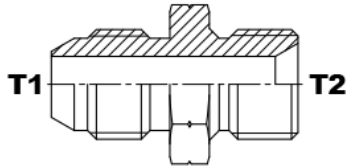

PART NUMBER	T1	T2
IA-10JB-03-04	3/8 - 24	1/4 - 19
IA-10JB-04-02	7/16 - 20	1/8 - 28
IA-10JB-04-04	7/16 - 20	1/4 - 19
IA-10JB-04-06	7/16 - 20	1/4 - 19
IA-10JB-04-08	7/16 - 20	1/2 - 14
IA-10JB-05-02	1/2 - 20	1/8 - 28
IA-10JB-05-04	1/2 - 20	1/4 - 19
IA-10JB-05-06	1/2 - 20	1/4 - 19
IA-10JB-05-08	1/2 - 20	1/2 - 14
IA-10JB-06-02	9/16 - 18	1/8 - 28
IA-10JB-06-04	9/16 - 18	1/4 - 19
IA-10JB-06-06	9/16 - 18	1/4 - 19
IA-10JB-06-08	9/16 - 18	1/2 - 14
IA-10JB-06-10	9/16 - 18	5/8 - 14
IA-10JB-06-12	9/16 - 18	3/4 - 14
IA-10JB-08-04	3/4 - 16	1/4 - 19
IA-10JB-08-06	3/4 - 16	1/4 - 19
IA-10JB-08-08	3/4 - 16	1/2 - 14
IA-10JB-08-10	3/4 - 16	5/8 - 14
IA-10JB-08-12	3/4 - 16	3/4 - 14
IA-10JB-08-16	3/4 - 16	1 - 11
IA-10JB-10-06	7/8 - 14	3/8 - 19
IA-10JB-10-08	7/8 - 14	1/2 - 14
IA-10JB-10-10	7/8 - 14	5/8 - 14
IA-10JB-10-12	7/8 - 14	3/4 - 14
IA-10JB-10-16	7/8 - 14	1 - 11
IA-10JB-12-06	1 1/16 - 12	1/4 - 19
IA-10JB-12-08	1 1/16 - 12	1/2 - 14
IA-10JB-12-10	1 1/16 - 12	5/8 - 14
IA-10JB-12-12	1 1/16 - 12	3/4 - 14
IA-10JB-12-16	1 1/16 - 12	1 - 11
IA-10JB-12-20	1 1/16 - 12	1 1/4 - 11
IA-10JB-14-16	1 3/16 - 12	1 - 11
IA-10JB-16-08	1 5/16 - 12	1/2 - 14
IA-10JB-16-12	1 5/16 - 12	3/4 - 14
IA-10JB-16-16	1 5/16 - 12	1 - 11
IA-10JB-16-20	1 5/16 - 12	1 1/4 - 11
IA-10JB-16-24	1 5/16 - 12	1 1/2 - 11
IA-10JB-20-12	1 5/8 - 12	3/4 - 14
IA-10JB-20-16	1 5/8 - 12	1 - 11
IA-10JB-20-20	1 5/8 - 12	1 1/4 - 11
IA-10JB-20-24	1 5/8 - 12	1 1/2 - 11
IA-10JB-20-32	1 5/8 - 12	2 - 11
IA-10JB-24-16	1 7/8 - 12	1 - 11
IA-10JB-24-20	1 7/8 - 12	1 1/4 - 11
IA-10JB-24-24	1 7/8 - 12	1 1/2 - 11
IA-10JB-24-32	1 7/8 - 12	2 - 11
IA-10JB-32-20	2 1/2 - 12	1 1/4 - 11
IA-10JB-32-24	2 1/2 - 12	1 1/2 - 11
IA-10JB-32-32	2 1/2 - 12	2 - 11

BSPP (60° SEAT & RIGID FEMALE)



WARNING This product can expose you to chemicals, which are known to the State of California to cause cancer or birth defects or other reproductive harm. For more information visit <https://www.p65warnings.ca.gov/>



IA-10JB-BS

JIC MALE x BSPP MALE W/ BONDED SEAL

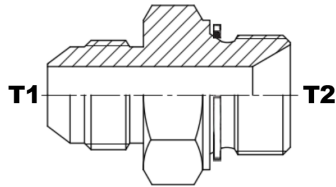

PART NUMBER	T1	T2
IA-10JB-04-02-BS	7/16 - 20	1/8 - 28
IA-10JB-04-04-BS	7/16 - 20	1/4 - 19
IA-10JB-04-06-BS	7/16 - 20	1/4 - 19
IA-10JB-05-04-BS	1/2 - 20	1/4 - 19
IA-10JB-05-06-BS	1/2 - 20	1/4 - 19
IA-10JB-06-02-BS	9/16 - 18	1/8 - 28
IA-10JB-06-04-BS	9/16 - 18	1/4 - 19
IA-10JB-06-06-BS	9/16 - 18	1/4 - 19
IA-10JB-06-08-BS	9/16 - 18	1/2 - 14
IA-10JB-06-12-BS	9/16 - 18	3/4 - 14
IA-10JB-08-06-BS	3/4 - 16	1/4 - 19
IA-10JB-08-08-BS	3/4 - 16	1/2 - 14
IA-10JB-08-10-BS	3/4 - 16	5/8 - 14
IA-10JB-08-12-BS	3/4 - 16	3/4 - 14
IA-10JB-08-16-BS	3/4 - 16	1 - 11
IA-10JB-10-06-BS	7/8 - 14	3/8 - 19
IA-10JB-10-08-BS	7/8 - 14	1/2 - 14
IA-10JB-10-10-BS	7/8 - 14	5/8 - 14
IA-10JB-10-12-BS	7/8 - 14	3/4 - 14
IA-10JB-12-06-BS	1 1/16 - 12	1/4 - 19
IA-10JB-12-08-BS	1 1/16 - 12	1/2 - 14
IA-10JB-12-10-BS	1 1/16 - 12	5/8 - 14
IA-10JB-12-12-BS	1 1/16 - 12	3/4 - 14
IA-10JB-12-16-BS	1 1/16 - 12	1 - 11
IA-10JB-16-12-BS	1 5/16 - 12	3/4 - 14
IA-10JB-16-16-BS	1 5/16 - 12	1 - 11
IA-10JB-16-20-BS	1 5/16 - 12	1 1/4 - 11
IA-10JB-20-16-BS	1 5/8 - 12	1 - 11
IA-10JB-20-20-BS	1 5/8 - 12	1 1/4 - 11

IA-10JB-WD

JIC MALE x BSPP MALE 60° + CAPTIVE SEAL

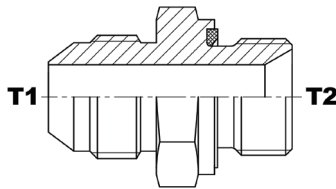

PART NUMBER	T1	T2
IA-10JB-04-02-WD	7/16 - 20	1/8 - 28
IA-10JB-04-04-WD	7/16 - 20	1/4 - 19
IA-10JB-04-06-WD	7/16 - 20	1/4 - 19
IA-10JB-04-08-WD	7/16 - 20	1/2 - 14
IA-10JB-05-04-WD	1/2 - 20	1/4 - 19
IA-10JB-05-06-WD	1/2 - 20	1/4 - 19
IA-10JB-06-04-WD	9/16 - 18	1/4 - 19
IA-10JB-06-06-WD	9/16 - 18	1/4 - 19
IA-10JB-06-08-WD	9/16 - 18	1/2 - 14
IA-10JB-06-12-WD	9/16 - 18	3/4 - 14
IA-10JB-08-04-WD	3/4 - 16	1/4 - 19
IA-10JB-08-06-WD	3/4 - 16	1/4 - 19
IA-10JB-08-08-WD	3/4 - 16	1/2 - 14
IA-10JB-08-12-WD	3/4 - 16	3/4 - 14
IA-10JB-10-08-WD	7/8 - 14	1/2 - 14
IA-10JB-10-12-WD	7/8 - 14	3/4 - 14
IA-10JB-12-08-WD	1 1/16 - 12	1/2 - 14
IA-10JB-12-12-WD	1 1/16 - 12	3/4 - 14
IA-10JB-16-12-WD	1 5/16 - 12	3/4 - 14
IA-10JB-16-16-WD	1 5/16 - 12	1 - 11
IA-10JB-20-20-WD	1 5/8 - 12	1 1/4 - 11
IA-10JB-24-20-WD	1 7/8 - 12	1 1/4 - 11
IA-10JB-24-24-WD	1 7/8 - 12	1 1/2 - 11

⚠ WARNING This product can expose you to chemicals, which are known to the State of California to cause cancer or birth defects or other reproductive harm. For more information visit <https://www.p65warnings.ca.gov/>

IA-19JB JIC MALE x BSPP MALE 90°

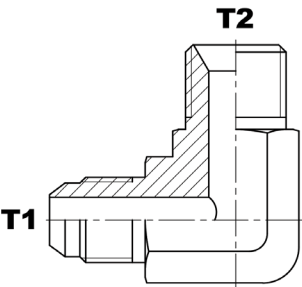
	PART NUMBER	T1	T2
		IA-19JB-04-04	7/16 - 20
	IA-19JB-06-04	9/16 - 18	1/4 - 19
	IA-19JB-06-06	9/16 - 18	3/8 - 19
	IA-19JB-08-06	3/4 - 16	3/8 - 19
	IA-19JB-08-08	3/4 - 16	1/2 - 14
	IA-19JB-10-08	7/8 - 14	1/2 - 14
	IA-19JB-12-12	1 1/16 - 12	3/4 - 14
	IA-19JB-16-16	1 5/16 - 12	1 - 11

IA-20JB JIC MALE x BSPP FEMALE SWIVEL

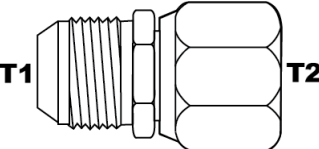
	PART NUMBER	T1	T2
		IA-20JB-04-02	7/16 - 20
	IA-20JB-04-04	7/16 - 20	1/4 - 19
	IA-20JB-04-06	7/16 - 20	3/8 - 19
	IA-20JB-05-04	1/2 - 20	1/4 - 19
	IA-20JB-06-04	9/16 - 18	1/4 - 19
	IA-20JB-06-06	9/16 - 18	3/8 - 19
	IA-20JB-06-08	9/16 - 18	1/2 - 14
	IA-20JB-08-06	3/4 - 16	3/8 - 19
	IA-20JB-08-08	3/4 - 16	1/2 - 14
	IA-20JB-08-10	3/4 - 16	5/8 - 14
	IA-20JB-08-12	3/4 - 16	3/4 - 14
	IA-20JB-10-06	7/8 - 14	3/8 - 19
	IA-20JB-10-08	7/8 - 14	1/2 - 14
	IA-20JB-10-10	7/8 - 14	5/8 - 14
	IA-20JB-12-12	1 1/16 - 12	3/4 - 14
	IA-20JB-16-16	1 5/16 - 12	1 - 11
	IA-20JB-20-20	1 5/8 - 12	1 1/4 - 11
	IA-20JB-24-24	1 7/8 - 12	1 1/2 - 11

IA-24JB JIC MALE x BSPP FEMALE SWIVEL 45°

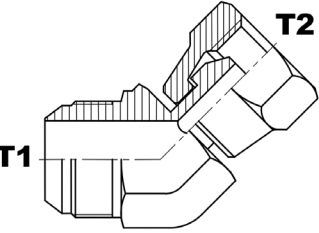
	PART NUMBER	T1	T2
		IA-24JB-04-04	7/16 - 20
	IA-24JB-06-06	9/16 - 18	3/8 - 19
	IA-24JB-08-08	3/4 - 16	1/2 - 14
	IA-24JB-10-10	7/8 - 14	5/8 - 14
	IA-24JB-12-12	1 1/16 - 12	3/4 - 14
	IA-24JB-16-16	1 5/16 - 12	1 - 11

WARNING This product can expose you to chemicals, which are known to the State of California to cause cancer or birth defects or other reproductive harm. For more information visit <https://www.p65warnings.ca.gov/>



IA-24JB-T JIC MALE x BSPP FEMALE SWIVEL 45° TUBE

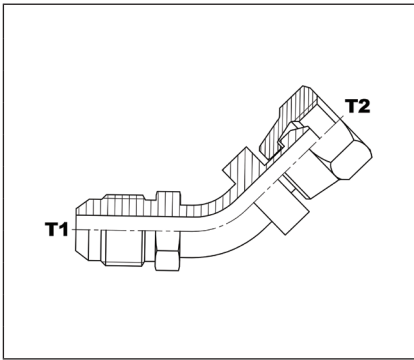

PART NUMBER	T1	T2
IA-24JB-04-04-T	7/16 - 20	1/4 - 19
IA-24JB-06-06-T	9/16 - 18	3/8 - 19
IA-24JB-08-08-T	3/4 - 16	1/2 - 14
IA-24JB-12-12-T	1 1/16 - 12	3/4 - 14

IA-29JB JIC MALE x 90° BSPP FEMALE SWIVEL

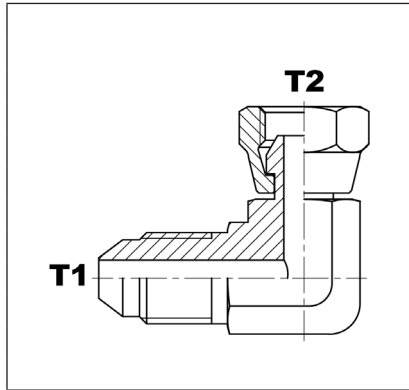

PART NUMBER	T1	T2
IA-29JB-04-04	7/16 - 20	1/4 - 19
IA-29JB-06-06	9/16 - 18	3/8 - 19
IA-29JB-08-08	3/4 - 16	1/2 - 14
IA-29JB-10-10	7/8 - 14	5/8 - 14
IA-29JB-12-12	1 1/16 - 12	3/4 - 14
IA-29JB-16-16	1 5/16 - 12	1 - 11

IA-29JB-T JIC MALE x 90° BSPP FEMALE SWIVEL TUBE

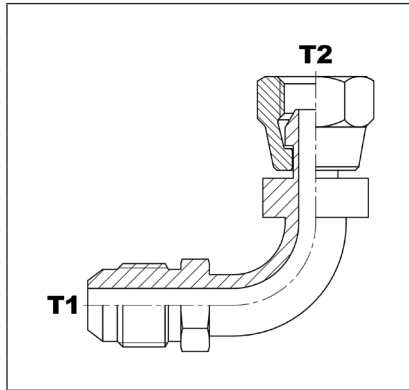

PART NUMBER	T1	T2
IA-29JB-04-04-T	7/16 - 20	1/4 - 19
IA-29JB-06-06-T	9/16 - 18	3/8 - 19
IA-29JB-08-08-T	3/4 - 16	1/2 - 14
IA-29JB-10-10-T	7/8 - 14	5/8 - 14
IA-29JB-12-12-T	1 1/16 - 12	3/4 - 14
IA-29JB-16-16-T	1 5/16 - 12	1 - 11
IA-29JB-24-24-T	1 7/8 - 12	1 1/2 - 11

⚠ WARNING This product can expose you to chemicals, which are known to the State of California to cause cancer or birth defects or other reproductive harm. For more information visit <https://www.p65warnings.ca.gov/>

IA-20BJ

BSPP MALE x JIC FEMALE SWIVEL

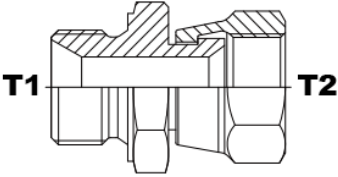
	PART NUMBER	T1	T2
	IA-20BJ-02-04	1/8 - 28	7/16 - 20
IA-20BJ-04-04	1/4 - 19	7/16 - 20	
IA-20BJ-04-05	1/4 - 19	1/2 - 20	
IA-20BJ-04-06	1/4 - 19	9/16 - 18	
IA-20BJ-06-04	3/8 - 19	7/16 - 20	
IA-20BJ-06-06	3/8 - 19	9/16 - 18	
IA-20BJ-06-08	3/8 - 19	3/4 - 16	
IA-20BJ-06-10	3/8 - 19	7/8 - 14	
IA-20BJ-08-05	1/2 - 14	1/2 - 20	
IA-20BJ-08-06	1/2 - 14	9/16 - 18	
IA-20BJ-08-08	1/2 - 14	3/4 - 16	
IA-20BJ-08-10	1/2 - 14	7/8 - 14	
IA-20BJ-08-12	1/2 - 14	1 1/16 - 12	
IA-20BJ-10-08	5/8 - 14	3/4 - 16	
IA-20BJ-10-10	5/8 - 14	7/8 - 14	
IA-20BJ-12-08	3/4 - 14	3/4 - 16	
IA-20BJ-12-10	3/4 - 14	7/8 - 14	
IA-20BJ-12-12	3/4 - 14	1 1/16 - 12	
IA-20BJ-12-16	3/4 - 14	1 5/16 - 12	
IA-20BJ-16-16	1 - 11	1 5/16 - 12	
IA-20BJ-20-20	1 1/4 - 11	1 5/8 - 12	
IA-20BJ-24-24	1 1/2 - 11	1 7/8 - 12	

IA-20BJ-WD

BSPP MALE +CAPTIVE SEAL x JIC FEM. SWIVEL

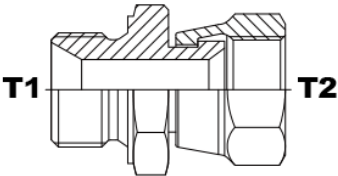
	PART NUMBER	T1	T2
	IA-20BJ-04-04-WD	1/4 - 19	7/16 - 20
IA-20BJ-04-05-WD	1/4 - 19	1/2 - 20	
IA-20BJ-04-06-WD	1/4 - 19	9/16 - 18	
IA-20BJ-04-08-WD	1/4 - 19	3/4 - 16	
IA-20BJ-06-04-WD	3/8 - 19	7/16 - 20	
IA-20BJ-06-06-WD	3/8 - 19	9/16 - 18	
IA-20BJ-06-08-WD	3/8 - 19	3/4 - 16	
IA-20BJ-08-06-WD	1/2 - 14	9/16 - 18	
IA-20BJ-08-08-WD	1/2 - 14	3/4 - 16	
IA-20BJ-08-10-WD	1/2 - 14	7/8 - 14	
IA-20BJ-12-12-WD	3/4 - 14	1 1/16 - 12	
IA-20BJ-12-16-WD	3/4 - 14	1 5/16 - 12	
IA-20BJ-16-16-WD	1 - 11	1 5/16 - 12	
IA-20BJ-20-16-WD	1 1/4 - 11	1 5/16 - 12	
IA-20BJ-20-20-WD	1 1/4 - 11	1 5/8 - 12	
IA-20BJ-24-24-WD	1 1/2 - 11	1 7/8 - 12	

IA-24BJ

BSPP MALE x JIC FEMALE SWIVEL 45°

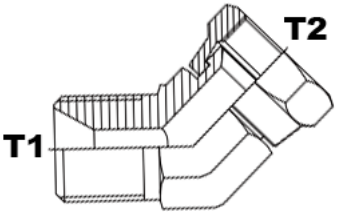
	PART NUMBER	T1	T2
	IA-24BJ-04-04	1/4 - 19	7/16 - 20
IA-24BJ-06-06	3/8 - 19	9/16 - 18	
IA-24BJ-08-08	1/2 - 14	3/4 - 16	
IA-24BJ-10-10	5/8 - 14	7/8 - 14	
IA-24BJ-12-12	3/4 - 14	1 1/16 - 12	
IA-24BJ-16-16	1 - 11	1 5/16 - 12	

WARNING This product can expose you to chemicals, which are known to the State of California to cause cancer or birth defects or other reproductive harm. For more information visit <https://www.p65warnings.ca.gov/>



IA-29BJ BSPP MALE x 90° JIC FEMALE SWIVEL

	PART NUMBER	T1	T2
	IA-29BJ-04-04	1/4 - 19	7/16 - 20
	IA-29BJ-06-06	3/8 - 19	9/16 - 18
	IA-29BJ-08-08	1/2 - 14	3/4 - 16
	IA-29BJ-12-12	3/4 - 14	1 1/16 - 12

IA-30JB JIC FEMALE x BSPP SWIVEL UNION

	PART NUMBER	T1	T2
	IA-30JB-04-04	7/16 - 20	1/4 - 19
	IA-30JB-06-04	9/16 - 18	1/4 - 19
	IA-30JB-06-06	9/16 - 18	3/8 - 19
	IA-30JB-06-08	9/16 - 18	1/2 - 14
	IA-30JB-08-06	3/4 - 16	3/8 - 19
	IA-30JB-08-08	3/4 - 16	1/2 - 14
	IA-30JB-10-10	7/8 - 14	5/8 - 14
	IA-30JB-12-12	1 1/16 - 12	3/4 - 14
	IA-30JB-16-16	1 5/16 - 12	1 - 11

IA-50JB JIC MALE x BSPP FEMALE RIGID

	PART NUMBER	T1	T2
	IA-50JB-04-02	7/16 - 20	1/8 - 28
	IA-50JB-04-04	7/16 - 20	1/4 - 19
	IA-50JB-06-04	9/16 - 18	1/4 - 19
	IA-50JB-06-06	9/16 - 18	3/8 - 19
	IA-50JB-08-06	3/4 - 16	3/8 - 19
	IA-50JB-08-08	3/4 - 16	1/2 - 14
	IA-50JB-10-08	7/8 - 14	1/2 - 14
	IA-50JB-12-08	1 1/16 - 12	1/2 - 14
	IA-50JB-12-12	1 1/16 - 12	3/4 - 14
	IA-50JB-16-16	1 5/16 - 12	1 - 11
	IA-50JB-20-20	1 5/8 - 12	1 1/4 - 11

IA-59JB JIC MALE x 90° BSPP FEMALE RIGID

	PART NUMBER	T1	T2
	IA-59JB-04-04	7/16 - 20	1/4 - 19
	IA-59JB-05-04	1/2 - 20	1/4 - 19
	IA-59JB-06-04	9/16 - 18	1/4 - 19
	IA-59JB-06-06	9/16 - 18	3/8 - 19
	IA-59JB-06-08	9/16 - 18	1/2 - 14
	IA-59JB-08-04	3/4 - 16	1/4 - 19
	IA-59JB-08-06	3/4 - 16	3/8 - 19
	IA-59JB-08-08	3/4 - 16	1/2 - 14
	IA-59JB-10-08	7/8 - 14	1/2 - 14
	IA-59JB-10-12	7/8 - 14	3/4 - 14
	IA-59JB-12-08	1 1/16 - 12	1/2 - 14
	IA-59JB-12-12	1 1/16 - 12	3/4 - 14
	IA-59JB-16-12	1 5/16 - 12	3/4 - 14
	IA-59JB-16-16	1 5/16 - 12	1 - 11

WARNING This product can expose you to chemicals, which are known to the State of California to cause cancer or birth defects or other reproductive harm. For more information visit <https://www.p65warnings.ca.gov/>

IA-40BJ

BSPF FEMALE RIGID x JIC FEMALE SWIVEL

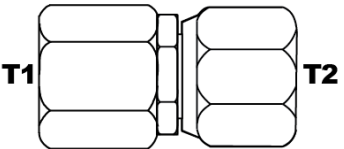
	PART NUMBER	T1	T2
	IA-40BJ-04-04	1/4 - 19	7/16 - 20
	IA-40BJ-06-06	3/8 - 19	9/16 - 18
	IA-40BJ-08-08	1/2 - 14	3/4 - 16
	IA-40BJ-12-12	3/4 - 14	1 1/16 - 12
	IA-40BJ-16-16	1 - 11	1 5/16 - 12
	IA-40BJ-20-20	1 1/4 - 11	1 5/8 - 12
	IA-40BJ-24-24	1 1/2 - 11	1 7/8 - 12

IA-10FB

ORFS MALE x BSPF MALE

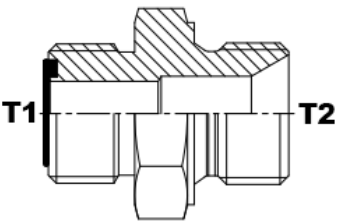
	PART NUMBER	T1	T2
	IA-10FB-04-02	9/16 - 18	1/8 - 28
	IA-10FB-04-04	9/16 - 18	1/4 - 19
	IA-10FB-04-06	9/16 - 18	3/8 - 19
	IA-10FB-04-08	9/16 - 18	1/2 - 14
	IA-10FB-04-12	9/16 - 18	3/4 - 14
	IA-10FB-06-02	11/16 - 16	1/8 - 28
	IA-10FB-06-04	11/16 - 16	1/4 - 19
	IA-10FB-06-06	11/16 - 16	3/8 - 19
	IA-10FB-06-08	11/16 - 16	1/2 - 14
	IA-10FB-06-12	11/16 - 16	3/4 - 14
	IA-10FB-08-04	13/16 - 16	1/4 - 19
	IA-10FB-08-06	13/16 - 16	3/8 - 19
	IA-10FB-08-08	13/16 - 16	1/2 - 14
	IA-10FB-08-12	13/16 - 16	3/4 - 14
	IA-10FB-08-16	13/16 - 16	1 - 11
	IA-10FB-10-06	1 - 14	3/8 - 19
	IA-10FB-10-08	1 - 14	1/2 - 14
	IA-10FB-10-12	1 - 14	3/4 - 14
	IA-10FB-10-16	1 - 14	1 - 11
	IA-10FB-12-08	1 3/16 - 12	1/2 - 14
	IA-10FB-12-10	1 3/16 - 12	5/8 - 14
	IA-10FB-12-12	1 3/16 - 12	3/4 - 14
	IA-10FB-12-16	1 3/16 - 12	1 - 11
	IA-10FB-12-20	1 3/16 - 12	1 1/4 - 11
	IA-10FB-16-12	1 7/16 - 12	3/4 - 14
	IA-10FB-16-16	1 7/16 - 12	1 - 11
	IA-10FB-20-16	1 11/16 - 12	1 - 11
IA-10FB-20-20	1 11/16 - 12	1 1/4 - 11	
IA-10FB-20-24	1 11/16 - 12	1 1/2 - 11	
IA-10FB-24-24	2 - 12	1 1/2 - 11	

WARNING This product can expose you to chemicals, which are known to the State of California to cause cancer or birth defects or other reproductive harm. For more information visit <https://www.p65warnings.ca.gov/>



IA-20BF

BSPP MALE 60° x ORFS FEMALE SWIVEL

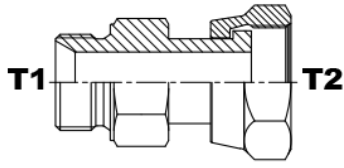

PART NUMBER	T1	T2
IA-20BF-04-04	1/4 - 19	9/16 - 18
IA-20BF-04-06	1/4 - 19	11/16 - 16
IA-20BF-06-06	3/8 - 19	11/16 - 16
IA-20BF-06-08	3/8 - 19	13/16 - 16
IA-20BF-08-06	1/2 - 14	11/16 - 16
IA-20BF-08-08	1/2 - 14	13/16 - 16
IA-20BF-08-10	1/2 - 14	1 - 14
IA-20BF-10-10	5/8 - 14	1 - 14
IA-20BF-12-12	3/4 - 14	1 3/16 - 12
IA-20BF-16-16	1 - 11	1 7/16 - 12
IA-20BF-20-20	1 1/4 - 11	1 11/16 - 12
IA-20BF-24-24	1 1/2 - 11	2 - 12

⚠ WARNING This product can expose you to chemicals, which are known to the State of California to cause cancer or birth defects or other reproductive harm. For more information visit <https://www.p65warnings.ca.gov/>

IA-19JT

JIC MALE x 90° BSPT MALE

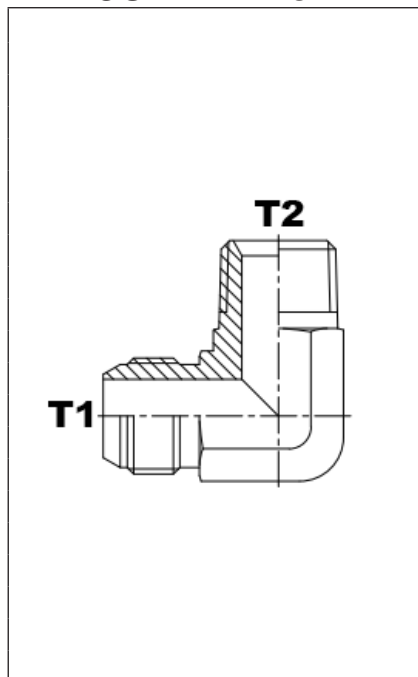

PART NUMBER	T1	T2
IA-19JT-04-02	7/16 - 20	1/8 - 28
IA-19JT-04-04	7/16 - 20	1/4 - 19
IA-19JT-04-06	7/16 - 20	3/8 - 19
IA-19JT-05-02	1/2 - 20	1/8 - 28
IA-19JT-05-04	1/2 - 20	1/4 - 19
IA-19JT-06-04	9/16 - 18	1/4 - 19
IA-19JT-06-06	9/16 - 18	3/8 - 19
IA-19JT-06-08	9/16 - 18	1/2 - 14
IA-19JT-08-06	3/4 - 16	3/8 - 19
IA-19JT-08-08	3/4 - 16	1/2 - 14
IA-19JT-08-12	3/4 - 16	3/4 - 14
IA-19JT-10-08	7/8 - 14	1/2 - 14
IA-19JT-12-08	1 1/16 - 12	1/2 - 14
IA-19JT-12-12	1 1/16 - 12	3/4 - 14
IA-19JT-16-12	1 5/16 - 12	3/4 - 14
IA-19JT-16-16	1 5/16 - 12	1 - 11
IA-19JT-20-20	1 5/8 - 12	1 1/4 - 11
IA-19JT-20-24	1 5/8 - 12	1 1/2 - 11
IA-19JT-24-24	1 7/8 - 12	1 1/2 - 11
IA-19JT-32-32	2 1/2 - 12	2 - 11

IA-AJJT

JIC MALE x BSPT MALE BRANCH TEE

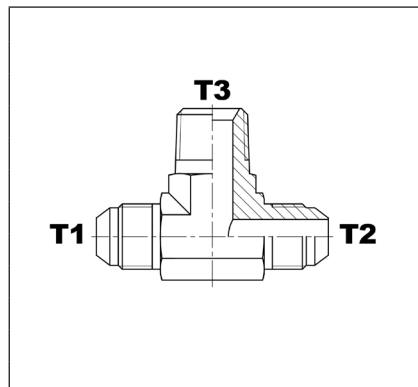

PART NUMBER	T1	T2	T3
IA-AJJT-04-04-02	7/16 - 20	7/16 - 20	1/8 - 28
IA-AJJT-04-04-04	7/16 - 20	7/16 - 20	1/4 - 19
IA-AJJT-06-06-04	9/16 - 18	9/16 - 18	1/4 - 19
IA-AJJT-06-06-06	9/16 - 18	9/16 - 18	3/8 - 19
IA-AJJT-08-08-06	3/4 - 16	3/4 - 16	3/8 - 19
IA-AJJT-08-08-08	3/4 - 16	3/4 - 16	1/2 - 14
IA-AJJT-12-12-12	1 1/16 - 12	1 1/16 - 12	3/4 - 14

IA-AJTJ

JIC MALE x BSPT MALE RUN TEE

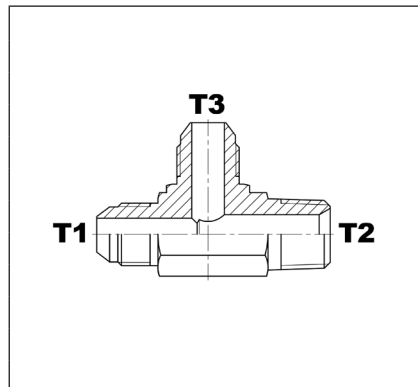

PART NUMBER	T1	T2	T3
IA-AJTJ-04-02-04	7/16 - 20	1/8 - 28	7/16 - 20
IA-AJTJ-04-04-04	7/16 - 20	1/4 - 19	7/16 - 20
IA-AJTJ-06-04-06	9/16 - 18	1/4 - 19	9/16 - 18
IA-AJTJ-06-06-06	9/16 - 18	3/8 - 19	9/16 - 18
IA-AJTJ-08-06-08	3/4 - 16	3/8 - 19	3/4 - 16
IA-AJTJ-08-08-08	3/4 - 16	1/2 - 14	3/4 - 16
IA-AJTJ-12-12-12	1 1/16 - 12	3/4 - 14	1 1/16 - 12

WARNING This product can expose you to chemicals, which are known to the State of California to cause cancer or birth defects or other reproductive harm. For more information visit <https://www.p65warnings.ca.gov/>



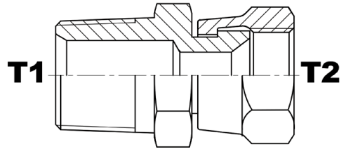

IA-20TJ BSPT MALE x JIC FEMALE SWIVEL

	PART NUMBER	T1	T2
	IA-20TJ-02-04	1/8 - 28	7/16 - 20
IA-20TJ-04-04	1/4 - 19	7/16 - 20	
IA-20TJ-04-05	1/4 - 19	1/2 - 20	
IA-20TJ-04-06	1/4 - 19	9/16 - 18	
IA-20TJ-06-05	3/8 - 19	1/2 - 20	
IA-20TJ-06-06	3/8 - 19	9/16 - 18	
IA-20TJ-06-08	3/8 - 19	3/4 - 16	
IA-20TJ-08-08	1/2 - 14	3/4 - 16	
IA-20TJ-08-10	1/2 - 14	7/8 - 14	
IA-20TJ-08-12	1/2 - 14	1 1/16 - 12	
IA-20TJ-12-12	3/4 - 14	1 1/16 - 12	
IA-20TJ-12-16	3/4 - 14	1 5/16 - 12	
IA-20TJ-16-16	1 - 11	1 5/16 - 12	
IA-20TJ-20-20	1 1/4 - 11	1 5/8 - 12	
IA-20TJ-24-24	1 1/2 - 11	1 7/8 - 12	

IA-29TJ BSPT MALE x 90° JIC FEMALE SWIVEL

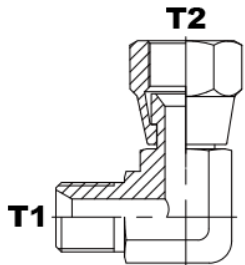
	PART NUMBER	T1	T2
	IA-29TJ-04-04	1/4 - 19	7/16 - 20
IA-29TJ-04-06	1/4 - 19	9/16 - 18	
IA-29TJ-06-06	3/8 - 19	9/16 - 18	
IA-29TJ-08-08	1/2 - 14	3/4 - 16	
IA-29TJ-08-10	1/2 - 14	7/8 - 14	
IA-29TJ-12-12	3/4 - 14	1 1/16 - 12	
IA-29TJ-16-16	1 - 11	1 5/16 - 12	

IA-50JT JIC MALE x BSPT FEMALE RIGID

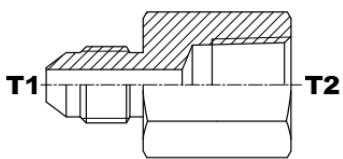
	PART NUMBER	T1	T2
	IA-50JT-04-02	7/16 - 20	1/8 - 28
IA-50JT-04-04	7/16 - 20	1/4 - 19	
IA-50JT-05-04	1/2 - 20	1/4 - 19	
IA-50JT-06-04	9/16 - 18	1/4 - 19	
IA-50JT-06-06	9/16 - 18	3/8 - 19	
IA-50JT-08-06	3/4 - 16	3/8 - 19	
IA-50JT-08-08	3/4 - 16	1/2 - 14	
IA-50JT-10-06	7/8 - 14	3/8 - 19	
IA-50JT-10-08	7/8 - 14	1/2 - 14	
IA-50JT-12-08	1 1/16 - 12	1/2 - 14	
IA-50JT-12-12	1 1/16 - 12	3/4 - 14	

⚠ WARNING This product can expose you to chemicals, which are known to the State of California to cause cancer or birth defects or other reproductive harm. For more information visit <https://www.p65warnings.ca.gov/>

IA-10FT

ORFS MALE x BSPT MALE

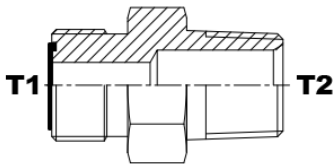

PART NUMBER	T1	T2
IA-10FT-04-02	9/16 - 18	1/8 - 28
IA-10FT-04-04	9/16 - 18	1/4 - 19
IA-10FT-04-06	9/16 - 18	3/8 - 19
IA-10FT-06-04	11/16 - 16	1/4 - 19
IA-10FT-06-06	11/16 - 16	3/8 - 19
IA-10FT-06-08	11/16 - 16	1/2 - 14
IA-10FT-08-08	13/16 - 16	1/2 - 14
IA-10FT-08-12	13/16 - 16	3/4 - 14
IA-10FT-10-08	1 - 14	1/2 - 14
IA-10FT-10-12	1 - 14	3/4 - 14
IA-10FT-10-16	1 - 14	1 - 11
IA-10FT-12-12	1 3/16 - 12	3/4 - 14
IA-10FT-12-16	1 3/16 - 12	1 - 11
IA-10FT-12-20	1 3/16 - 12	1 1/4 - 11
IA-10FT-16-12	1 7/16 - 12	3/4 - 14
IA-10FT-16-16	1 7/16 - 12	1 - 11
IA-10FT-16-20	1 7/16 - 12	1 1/4 - 11
IA-10FT-16-24	1 7/16 - 12	1 1/2 - 11
IA-10FT-20-16	1 11/16 - 12	1 - 11
IA-10FT-20-20	1 11/16 - 12	1 1/4 - 11
IA-10FT-20-24	1 11/16 - 12	1 1/2 - 11
IA-10FT-24-20	2 - 12	1 1/4 - 11
IA-10FT-24-24	2 - 12	1 1/2 - 11
IA-10FT-24-32	2 - 12	2 - 11

IA-14FT

ORFS MALE x 45° BSPT MALE

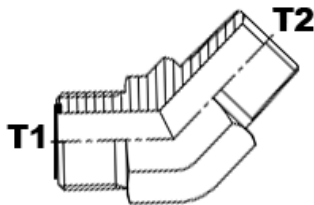

PART NUMBER	T1	T2
IA-14FT-04-04	9/16 - 18	1/4 - 19
IA-14FT-04-06	9/16 - 18	3/8 - 19
IA-14FT-06-06	11/16 - 16	3/8 - 19
IA-14FT-06-08	11/16 - 16	1/2 - 14
IA-14FT-08-08	13/16 - 16	1/2 - 14
IA-14FT-08-12	13/16 - 16	3/4 - 14
IA-14FT-10-08	1 - 14	1/2 - 14
IA-14FT-12-12	1 3/16 - 12	3/4 - 14
IA-14FT-12-16	1 3/16 - 12	1 - 11
IA-14FT-16-16	1 7/16 - 12	1 - 11
IA-14FT-16-20	1 7/16 - 12	1 1/4 - 11
IA-14FT-20-16	1 11/16 - 12	1 - 11
IA-14FT-20-20	1 11/16 - 12	1 1/4 - 11
IA-14FT-20-24	1 11/16 - 12	1 1/2 - 11
IA-14FT-24-24	2 - 12	1 1/2 - 11
IA-14FT-24-32	2 - 12	2 - 11



WARNING This product can expose you to chemicals, which are known to the State of California to cause cancer or birth defects or other reproductive harm. For more information visit <https://www.p65warnings.ca.gov/>





IA-19FT ORFS MALE x 90° BSPT MALE

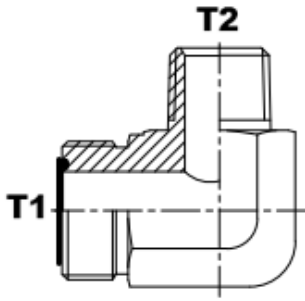

PART NUMBER	T1	T2
IA-19FT-04-02	9/16 - 18	1/8 - 28
IA-19FT-04-04	9/16 - 18	1/4 - 19
IA-19FT-04-06	9/16 - 18	3/8 - 19
IA-19FT-06-04	11/16 - 16	1/4 - 19
IA-19FT-06-06	11/16 - 16	3/8 - 19
IA-19FT-06-08	11/16 - 16	1/2 - 14
IA-19FT-08-06	13/16 - 16	3/8 - 19
IA-19FT-08-08	13/16 - 16	1/2 - 14
IA-19FT-08-12	13/16 - 16	3/4 - 14
IA-19FT-10-08	1 - 14	1/2 - 14
IA-19FT-12-12	1 3/16 - 12	3/4 - 14
IA-19FT-12-16	1 3/16 - 12	1 - 11
IA-19FT-16-16	1 7/16 - 12	1 - 11
IA-19FT-16-20	1 7/16 - 12	1 1/4 - 11
IA-19FT-20-16	1 11/16 - 12	1 - 11
IA-19FT-20-20	1 11/16 - 12	1 1/4 - 11
IA-19FT-20-24	1 11/16 - 12	1 1/2 - 11
IA-19FT-24-24	2 - 12	1 1/2 - 11
IA-19FT-24-32	2 - 12	2 - 11

WARNING This product can expose you to chemicals, which are known to the State of California to cause cancer or birth defects or other reproductive harm. For more information visit <https://www.p65warnings.ca.gov/>

IA-0SA, 0SC, 0SD

DIN LL, L & S METRIC BITE SLEEVE

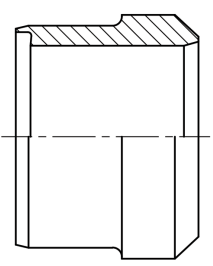

PART NUMBER		T1	T2	T3	T4
IA-0SA-04	LL	4			
IA-0SA-06		6			
IA-0SA-08		8			
IA-0SA-10		10			
IA-0SA-12		12			
IA-0SCD-06	L OR S	6			
IA-0SCD-08		8			
IA-0SCD-10		10			
IA-0SCD-12		12			
IA-0SC-15	L	15			
IA-0SC-18		18			
IA-0SC-22		22			
IA-0SC-28		28			
IA-0SC-35		35			
IA-0SC-42		42			
IA-0SD-14	S	14			
IA-0SD-16		16			
IA-0SD-20		20			
IA-0SD-25		25			
IA-0SD-30		30			
IA-0SD-38		38			

*Note: All Male DIN types include metric tube nut and metric bite sleeve.

*Note: All Female DIN Swivels are DKO Type.

IA-0NA, 0NC, 0ND

DIN LL, L & S METRIC TUBE NUT

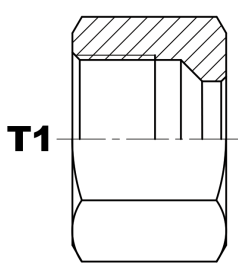

PART NUMBER		T1	T2	T3	T4
IA-0NA-04	LL	8 X 1.0	4		
IA-0NA-06		10 X 1.0	6		
IA-0NA-08		12 X 1.0	8		
IA-0NA-10		14 X 1.0	10		
IA-0NA-12		16 X 1.0	12		
IA-0NC-06	L	12 X 1.5	6		
IA-0NC-08		14 X 1.5	8		
IA-0NC-10		16 X 1.5	10		
IA-0NC-12		18 X 1.5	12		
IA-0NC-15		22 X 1.5	15		
IA-0NC-18		26 X 1.5	18		
IA-0NC-22		30 X 2.0	22		
IA-0NC-28		36 X 2.0	28		
IA-0NC-35		45 X 2.0	35		
IA-0NC-42		52 X 2.0	42		
IA-0ND-06	S	14 X 1.5	6		
IA-0ND-08		16 X 1.5	8		
IA-0ND-10		18 X 1.5	10		
IA-0ND-12		20 X 1.5	12		
IA-0ND-14		22 X 1.5	14		
IA-0ND-16		24 X 1.5	16		
IA-0ND-20		30 X 2.0	20		
IA-0ND-25		36 X 2.0	25		
IA-0ND-30		42 X 2.0	30		
IA-0ND-38		52 X 2.0	38		

*Note: All Male DIN types include metric tube nut and metric bite sleeve.

*Note: All Female DIN Swivels are DKO Type.



WARNING This product can expose you to chemicals, which are known to the State of California to cause cancer or birth defects or other reproductive harm. For more information visit <https://www.p65warnings.ca.gov/>





IA-0BC, 0BD

DIN LIGHT & HEAVY BLANKING PLUG

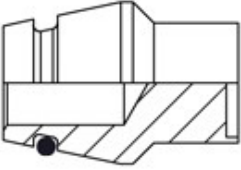
	PART NUMBER		Tube Size
	L OR S	IA-0BCD-06	6
		IA-0BCD-08	8
		IA-0BCD-10	10
		IA-0BCD-12	12
	L	IA-0BC-15	15
		IA-0BC-18	18
		IA-0BC-22	22
		IA-0BC-28	28
		IA-0BC-35	35
	S	IA-0BC-42	42
IA-0BD-14		14	
IA-0BD-16		16	
IA-0BD-20		20	
IA-0BD-25		25	
IA-0BD-30		30	
	IA-0BD-38	38	

*Note: All Male DIN types include metric tube nut and metric bite sleeve.

*Note: All Female DIN Swivels are DKO Type.

IA-0CA, 0CC,0CD

DIN L & S FEMALE CAP

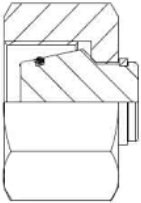
	PART NUMBER		T1
	L	IA-0CC-06	12 X 1.5
		IA-0CC-08	14 X 1.5
		IA-0CC-10	16 X 1.5
		IA-0CC-12	18 X 1.5
		IA-0CC-15	22 X 1.5
		IA-0CC-18	26 X 1.5
		IA-0CC-22	30 X 2.0
		IA-0CC-28	36 X 2.0
		IA-0CC-35	45 X 2.0
		IA-0CC-42	52 X 2.0
S	IA-0CD-06	14 X 1.5	
	IA-0CD-08	16 X 1.5	
	IA-0CD-10	18 X 1.5	
	IA-0CD-12	20 X 1.5	
	IA-0CD-14	22 X 1.5	
	IA-0CD-16	24 X 1.5	
	IA-0CD-20	30 X 2.0	
	IA-0CD-25	36 X 2.0	
	IA-0CD-30	42 X 2.0	
	IA-0CD-38	52 X 2.0	

*Note: All Male DIN types include metric tube nut and metric bite sleeve.

*Note: All Female DIN Swivels are DKO Type.



WARNING This product can expose you to chemicals, which are known to the State of California to cause cancer or birth defects or other reproductive harm. For more information visit <https://www.p65warnings.ca.gov/>

IA-0PA, 0PC, 0PD

DIN L & S MALE PLUG

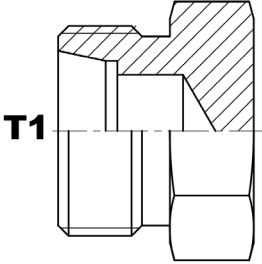
T1	PART NUMBER		T1	
		L	IA-0PC-06	12 X 1.5
IA-0PC-08			14 X 1.5	
IA-0PC-10			16 X 1.5	
IA-0PC-12			18 X 1.5	
IA-0PC-15			22 X 1.5	
IA-0PC-18			26 X 1.5	
IA-0PC-22			30 X 2.0	
IA-0PC-28			36 X 2.0	
IA-0PC-35			45 X 2.0	
IA-0PC-42			52 X 2.0	
S			IA-0PD-06	14 X 1.5
			IA-0PD-08	16 X 1.5
		IA-0PD-10	18 X 1.5	
		IA-0PD-12	20 X 1.5	
		IA-0PD-14	22 X 1.5	
		IA-0PD-16	24 X 1.5	
		IA-0PD-20	30 X 2.0	
		IA-0PD-25	36 X 2.0	
IA-0PD-30		42 X 2.0		
IA-0PD-38		52 X 2.0		

*Note: All Male DIN types include metric tube nut and metric bite sleeve.

*Note: All Female DIN Swivels are DKO Type.

DIN BITE-TYPE 12° SEAT



WARNING This product can expose you to chemicals, which are known to the State of California to cause cancer or birth defects or other reproductive harm. For more information visit <https://www.p65warnings.ca.gov/>

IA-10AA, 10CC, 10DD

DIN LL, L & S TUBE UNION

DIN BITE-TYPE 12° SEAT

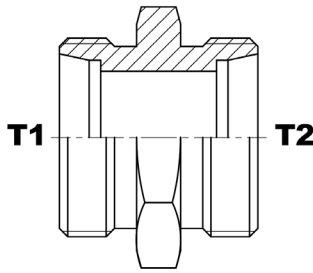

PART NUMBER		T1	T2
IA-10CC-06-06	L	12 X 1.5	12 X 1.5
IA-10CC-08-06		14 X 1.5	12 X 1.5
IA-10CC-08-08		14 X 1.5	14 X 1.5
IA-10CC-10-06		16 X 1.5	12 X 1.5
IA-10CC-10-08		16 X 1.5	14 X 1.5
IA-10CC-10-10		16 X 1.5	16 X 1.5
IA-10CC-12-06		18 X 1.5	12 X 1.5
IA-10CC-12-08		18 X 1.5	14 X 1.5
IA-10CC-12-10		18 X 1.5	16 X 1.5
IA-10CC-12-12		18 X 1.5	18 X 1.5
IA-10CC-15-10		22 X 1.5	16 X 1.5
IA-10CC-15-12		22 X 1.5	18 X 1.5
IA-10CC-15-15		22 X 1.5	22 X 1.5
IA-10CC-18-10		26 X 1.5	16 X 1.5
IA-10CC-18-12		26 X 1.5	18 X 1.5
IA-10CC-18-15		26 X 1.5	22 X 1.5
IA-10CC-18-18		26 X 1.5	26 X 1.5
IA-10CC-22-12		30 X 2.0	18 X 1.5
IA-10CC-22-15		30 X 2.0	22 X 1.5
IA-10CC-22-18		30 X 2.0	26 X 1.5
IA-10CC-22-22		30 X 2.0	30 X 2.0
IA-10CC-28-12		36 X 2.0	18 X 1.5
IA-10CC-28-18		36 X 2.0	26 X 1.5
IA-10CC-28-22		36 X 2.0	30 X 2.0
IA-10CC-28-28		36 X 2.0	36 X 2.0
IA-10CC-35-22		45 X 2.0	30 X 2.0
IA-10CC-35-28		45 X 2.0	36 X 2.0
IA-10CC-35-35		45 X 2.0	45 X 2.0
IA-10CC-42-42	52 X 2.0	52 X 2.0	
IA-10DD-06-06	S	14 X 1.5	14 X 1.5
IA-10DD-08-06		16 X 1.5	14 X 1.5
IA-10DD-08-08		16 X 1.5	16 X 1.5
IA-10DD-10-06		18 X 1.5	14 X 1.5
IA-10DD-10-08		18 X 1.5	16 X 1.5
IA-10DD-10-10		18 X 1.5	18 X 1.5
IA-10DD-12-06		20 X 1.5	14 X 1.5
IA-10DD-12-08		20 X 1.5	16 X 1.5
IA-10DD-12-10		20 X 1.5	18 X 1.5
IA-10DD-12-12		20 X 1.5	20 X 1.5
IA-10DD-14-10		22 X 1.5	18 X 1.5
IA-10DD-14-12		22 X 1.5	20 X 1.5
IA-10DD-14-14		22 X 1.5	22 X 1.5
IA-10DD-16-12		24 X 1.5	20 X 1.5
IA-10DD-16-14		24 X 1.5	22 X 1.5
IA-10DD-16-16		24 X 1.5	24 X 1.5
IA-10DD-20-10		30 X 2.0	18 X 1.5
IA-10DD-20-12		30 X 2.0	20 X 1.5
IA-10DD-20-16		30 X 2.0	24 X 1.5
IA-10DD-20-20		30 X 2.0	30 X 2.0
IA-10DD-25-16		36 X 2.0	24 X 1.5
IA-10DD-25-20		36 X 2.0	30 X 2.0
IA-10DD-25-25		36 X 2.0	36 X 2.0
IA-10DD-30-20		42 X 2.0	30 X 2.0
IA-10DD-30-25		42 X 2.0	36 X 2.0
IA-10DD-30-30		42 X 2.0	42 X 2.0
IA-10DD-38-30		52 X 2.0	42 X 2.0
IA-10DD-38-38		52 X 2.0	52 X 2.0

*Note: All Male DIN types include metric tube nut and metric bite sleeve.

*Note: All Female DIN Swivels are DKO Type.



WARNING This product can expose you to chemicals, which are known to the State of California to cause cancer or birth defects or other reproductive harm. For more information visit <https://www.p65warnings.ca.gov/>

IA-19AA, 19CC, 19DD

90° DIN LL, L & S TUBE UNION

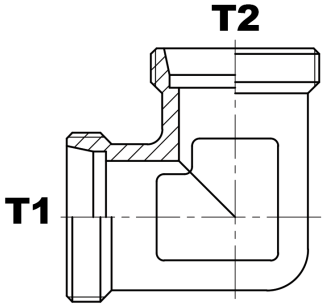
	PART NUMBER		T1	T2
		L	IA-19CC-06-06	12 X 1.5
IA-19CC-08-08			14 X 1.5	14 X 1.5
IA-19CC-10-10			16 X 1.5	16 X 1.5
IA-19CC-12-12			18 X 1.5	18 X 1.5
IA-19CC-15-15			22 X 1.5	22 X 1.5
IA-19CC-18-18			26 X 1.5	26 X 1.5
IA-19CC-22-22			30 X 2.0	30 X 2.0
IA-19CC-28-28			36 X 2.0	36 X 2.0
IA-19CC-35-35			45 X 2.0	45 X 2.0
IA-19CC-42-42			52 X 2.0	52 X 2.0
S		IA-19DD-06-06	14 X 1.5	14 X 1.5
		IA-19DD-08-08	16 X 1.5	16 X 1.5
		IA-19DD-10-10	18 X 1.5	18 X 1.5
		IA-19DD-12-12	20 X 1.5	20 X 1.5
		IA-19DD-14-14	22 X 1.5	22 X 1.5
		IA-19DD-16-16	24 X 1.5	24 X 1.5
		IA-19DD-20-20	30 X 2.0	30 X 2.0
		IA-19DD-25-25	36 X 2.0	36 X 2.0
		IA-19DD-30-30	42 X 2.0	42 X 2.0
IA-19DD-38-38	52 X 2.0	52 X 2.0		

*Note: All Male DIN types include metric tube nut and metric bite sleeve.

*Note: All Female DIN Swivels are DKO Type.

IA-AAAA, ACCC, ADDD

DIN LL, L & S TUBE UNION TEE

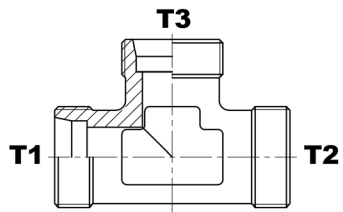
	PART NUMBER			T1	T2	T3
		L	IA-ACCC-06-06-06	12 X 1.5	12 X 1.5	12 X 1.5
IA-ACCC-08-08-08			14 X 1.5	14 X 1.5	14 X 1.5	
IA-ACCC-10-10-10			16 X 1.5	16 X 1.5	16 X 1.5	
IA-ACCC-12-12-12			18 X 1.5	18 X 1.5	18 X 1.5	
IA-ACCC-15-12-15			22 X 1.5	18 X 1.5	22 X 1.5	
IA-ACCC-15-15-15			22 X 1.5	22 X 1.5	22 X 1.5	
IA-ACCC-18-18-18			26 X 1.5	26 X 1.5	26 X 1.5	
IA-ACCC-22-22-22			30 X 2.0	30 X 2.0	30 X 2.0	
IA-ACCC-28-28-28			36 X 2.0	36 X 2.0	36 X 2.0	
IA-ACCC-35-35-35			45 X 2.0	45 X 2.0	45 X 2.0	
IA-ACCC-42-42-42			52 X 2.0	52 X 2.0	52 X 2.0	
S			IA-ADDD-06-06-06	14 X 1.5	14 X 1.5	14 X 1.5
		IA-ADDD-08-08-08	16 X 1.5	16 X 1.5	16 X 1.5	
		IA-ADDD-10-10-10	18 X 1.5	18 X 1.5	18 X 1.5	
		IA-ADDD-12-12-12	20 X 1.5	20 X 1.5	20 X 1.5	
		IA-ADDD-14-14-14	22 X 1.5	22 X 1.5	22 X 1.5	
		IA-ADDD-16-06-16	24 X 1.5	14 X 1.5	24 X 1.5	
		IA-ADDD-16-16-16	24 X 1.5	24 X 1.5	24 X 1.5	
		IA-ADDD-20-20-20	30 X 2.0	30 X 2.0	30 X 2.0	
		IA-ADDD-25-25-25	36 X 2.0	36 X 2.0	36 X 2.0	
		IA-ADDD-30-30-30	42 X 2.0	42 X 2.0	42 X 2.0	
		IA-ADDD-38-38-38	52 X 2.0	52 X 2.0	52 X 2.0	

*Note: All Male DIN types include metric tube nut and metric bite sleeve.

*Note: All Female DIN Swivels are DKO Type.



WARNING This product can expose you to chemicals, which are known to the State of California to cause cancer or birth defects or other reproductive harm. For more information visit <https://www.p65warnings.ca.gov/>



IA-XCCCC, XDDDD

DIN L & S TUBE UNION CROSS

PART NUMBER		T1	T2	T3	T4	
		IA-XAAAA-04-04-04-04	LL	8 X 1.0	8 X 1.0	8 X 1.0
IA-XAAAA-05-05-05-05	10 X 1.0	10 X 1.0		10 X 1.0	10 X 1.0	
IA-XAAAA-06-06-06-06	10 X 1.0	10 X 1.0		10 X 1.0	10 X 1.0	
IA-XAAAA-08-08-08-08	12 X 1.0	12 X 1.0		12 X 1.0	12 X 1.0	
IA-XCCCC-06-06-06-06	L	12 X 1.5	12 X 1.5	12 X 1.5	12 X 1.5	
IA-XCCCC-08-08-08-08		14 X 1.5	14 X 1.5	14 X 1.5	14 X 1.5	
IA-XCCCC-10-10-10-10		16 X 1.5	16 X 1.5	16 X 1.5	16 X 1.5	
IA-XCCCC-12-12-12-12		18 X 1.5	18 X 1.5	18 X 1.5	18 X 1.5	
IA-XCCCC-15-15-15-15		22 X 1.5	22 X 1.5	22 X 1.5	22 X 1.5	
IA-XCCCC-18-18-18-18		26 X 1.5	26 X 1.5	26 X 1.5	26 X 1.5	
IA-XCCCC-22-22-22-22		30 X 2.0	30 X 2.0	30 X 2.0	30 X 2.0	
IA-XCCCC-28-28-28-28		36 X 2.0	36 X 2.0	36 X 2.0	36 X 2.0	
IA-XCCCC-35-35-35-35		45 X 2.0	45 X 2.0	45 X 2.0	45 X 2.0	
IA-XCCCC-42-42-42-42		52 X 2.0	52 X 2.0	52 X 2.0	52 X 2.0	
IA-XDDDD-06-06-06-06		S	14 X 1.5	14 X 1.5	14 X 1.5	14 X 1.5
IA-XDDDD-08-08-08-08			16 X 1.5	16 X 1.5	16 X 1.5	16 X 1.5
IA-XDDDD-10-10-10-10	18 X 1.5		18 X 1.5	18 X 1.5	18 X 1.5	
IA-XDDDD-12-12-12-12	20 X 1.5		20 X 1.5	20 X 1.5	20 X 1.5	
IA-XDDDD-14-14-14-14	22 X 1.5		22 X 1.5	22 X 1.5	22 X 1.5	
IA-XDDDD-16-16-16-16	24 X 1.5		24 X 1.5	24 X 1.5	24 X 1.5	
IA-XDDDD-20-20-20-20	30 X 2.0		30 X 2.0	30 X 2.0	30 X 2.0	
IA-XDDDD-25-25-25-25	36 X 2.0		36 X 2.0	36 X 2.0	36 X 2.0	
IA-XDDDD-30-30-30-30	42 X 2.0		42 X 2.0	42 X 2.0	42 X 2.0	
IA-XDDDD-38-38-38-38	52 X 2.0		52 X 2.0	52 X 2.0	52 X 2.0	

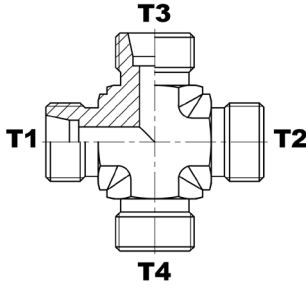

*Note: All Male DIN types include metric tube nut and metric bite sleeve.

*Note: All Female DIN Swivels are DKO Type.

IA-60CC, 60DD

DIN L & S TUBE BULKHEAD UNION W/ LOCKNUT

PART NUMBER		T1	T2
		IA-60CC-06-06-LN	L
IA-60CC-08-08-LN	14 X 1.5	14 X 1.5	
IA-60CC-10-10-LN	16 X 1.5	16 X 1.5	
IA-60CC-12-12-LN	18 X 1.5	18 X 1.5	
IA-60CC-15-15-LN	22 X 1.5	22 X 1.5	
IA-60CC-18-18-LN	26 X 1.5	26 X 1.5	
IA-60CC-22-22-LN	30 X 2.0	30 X 2.0	
IA-60CC-28-28-LN	36 X 2.0	36 X 2.0	
IA-60CC-35-35-LN	45 X 2.0	45 X 2.0	
IA-60CC-42-42-LN	52 X 2.0	52 X 2.0	
IA-60DD-06-06-LN	S	14 X 1.5	14 X 1.5
IA-60DD-08-08-LN		16 X 1.5	16 X 1.5
IA-60DD-10-10-LN		18 X 1.5	18 X 1.5
IA-60DD-12-12-LN		20 X 1.5	20 X 1.5
IA-60DD-14-14-LN		22 X 1.5	22 X 1.5
IA-60DD-16-16-LN		24 X 1.5	24 X 1.5
IA-60DD-20-20-LN		30 X 2.0	30 X 2.0
IA-60DD-25-25-LN		36 X 2.0	36 X 2.0
IA-60DD-30-30-LN		42 X 2.0	42 X 2.0
IA-60DD-38-38-LN		52 X 2.0	52 X 2.0

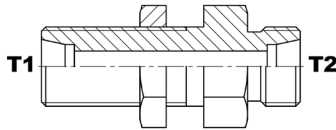

*Note: All Male DIN types include metric tube nut and metric bite sleeve.

*Note: All Female DIN Swivels are DKO Type.



WARNING This product can expose you to chemicals, which are known to the State of California to cause cancer or birth defects or other reproductive harm. For more information visit <https://www.p65warnings.ca.gov/>

IA-69CC, 69DD

90° DIN L & S TUBE BULKHEAD UNION W/ LOCKNUT

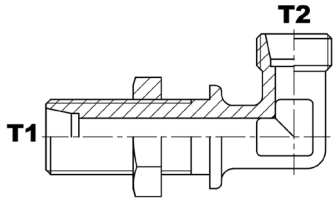

PART NUMBER		T1	T2
IA-69CC-06-06-LN	L	12 X 1.5	12 X 1.5
IA-69CC-08-08-LN		14 X 1.5	14 X 1.5
IA-69CC-10-10-LN		16 X 1.5	16 X 1.5
IA-69CC-12-12-LN		18 X 1.5	18 X 1.5
IA-69CC-15-15-LN		22 X 1.5	22 X 1.5
IA-69CC-18-18-LN		26 X 1.5	26 X 1.5
IA-69CC-22-22-LN		30 X 2.0	30 X 2.0
IA-69CC-28-28-LN		36 X 2.0	36 X 2.0
IA-69CC-35-35-LN		45 X 2.0	45 X 2.0
IA-69CC-42-42-LN		52 X 2.0	52 X 2.0
IA-69DD-06-06-LN	S	14 X 1.5	14 X 1.5
IA-69DD-08-08-LN		16 X 1.5	16 X 1.5
IA-69DD-10-10-LN		18 X 1.5	18 X 1.5
IA-69DD-12-12-LN		20 X 1.5	20 X 1.5
IA-69DD-14-14-LN		22 X 1.5	22 X 1.5
IA-69DD-16-16-LN		24 X 1.5	24 X 1.5
IA-69DD-20-20-LN		30 X 2.0	30 X 2.0
IA-69DD-25-25-LN		36 X 2.0	36 X 2.0
IA-69DD-30-30-LN		42 X 2.0	42 X 2.0
IA-69DD-38-38-LN		52 X 2.0	52 X 2.0

*Note: All Male DIN types include metric tube nut and metric bite sleeve.

*Note: All Female DIN Swivels are DKO Type.

IA-60CC-W, 60DD-W

DIN L & S TUBE WELD BULKHEAD UNION

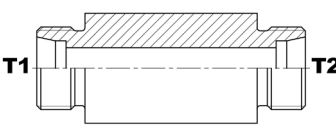

PART NUMBER		T1	T2
IA-60CC-06-06-W	L	12 X 1.5	12 X 1.5
IA-60CC-08-08-W		14 X 1.5	14 X 1.5
IA-60CC-10-10-W		16 X 1.5	16 X 1.5
IA-60CC-12-12-W		18 X 1.5	18 X 1.5
IA-60DD-06-06-W	S	14 X 1.5	14 X 1.5
IA-60DD-08-08-W		16 X 1.5	16 X 1.5
IA-60DD-10-10-W		18 X 1.5	18 X 1.5
IA-60DD-12-12-W		20 X 1.5	20 X 1.5

*Quoted Upon Request

*Note: All Male DIN types include metric tube nut and metric bite sleeve.

*Note: All Female DIN Swivels are DKO Type.

WARNING This product can expose you to chemicals, which are known to the State of California to cause cancer or birth defects or other reproductive harm. For more information visit <https://www.p65warnings.ca.gov/>



IA-20CC, 20DD

DIN L & S TUBE REDUCER / INCREASER

	PART NUMBER		T1	T2
			IA-20CC-06-08	
	IA-20CC-06-10		12 X 1.5	16 X 1.5
	IA-20CC-06-12		12 X 1.5	18 X 1.5
	IA-20CC-06-15		12 X 1.5	22 X 1.5
	IA-20CC-06-18		12 X 1.5	26 X 1.5
	IA-20CC-06-22		12 X 1.5	30 X 2.0
	IA-20CC-06-28		12 X 1.5	36 X 2.0
	IA-20CC-06-35		12 X 1.5	45 X 2.0
	IA-20CC-06-42		12 X 1.5	52 X 2.0
	IA-20CC-08-10		14 X 1.5	16 X 1.5
	IA-20CC-08-12		14 X 1.5	18 X 1.5
	IA-20CC-08-15		14 X 1.5	22 X 1.5
	IA-20CC-08-18		14 X 1.5	26 X 1.5
	IA-20CC-08-22		14 X 1.5	30 X 2.0
	IA-20CC-08-28		14 X 1.5	36 X 2.0
	IA-20CC-08-35		14 X 1.5	45 X 2.0
	IA-20CC-08-42		14 X 1.5	52 X 2.0
	IA-20CC-10-12		16 X 1.5	18 X 1.5
	IA-20CC-10-15		16 X 1.5	22 X 1.5
	IA-20CC-10-18		16 X 1.5	26 X 1.5
	IA-20CC-10-22		16 X 1.5	30 X 2.0
	IA-20CC-10-28		16 X 1.5	36 X 2.0
	IA-20CC-10-35		16 X 1.5	45 X 2.0
	IA-20CC-10-42		16 X 1.5	52 X 2.0
	IA-20CC-12-15	L	18 X 1.5	22 X 1.5
	IA-20CC-12-18		18 X 1.5	26 X 1.5
	IA-20CC-12-22		18 X 1.5	30 X 2.0
	IA-20CC-12-28		18 X 1.5	36 X 2.0
	IA-20CC-12-35		18 X 1.5	45 X 2.0
	IA-20CC-12-42		18 X 1.5	52 X 2.0
	IA-20CC-15-15		22 X 1.5	22 X 1.5
	IA-20CC-15-18		22 X 1.5	26 X 1.5
	IA-20CC-15-22		22 X 1.5	30 X 2.0
	IA-20CC-15-28		22 X 1.5	36 X 2.0
	IA-20CC-15-35		22 X 1.5	45 X 2.0
	IA-20CC-15-42		22 X 1.5	52 X 2.0
	IA-20CC-18-15		26 X 1.5	22 X 1.5
	IA-20CC-18-22		26 X 1.5	30 X 2.0
	IA-20CC-18-28		26 X 1.5	36 X 2.0
	IA-20CC-18-35		26 X 1.5	45 X 2.0
	IA-20CC-18-42		26 X 1.5	52 X 2.0
	IA-20CC-22-28		30 X 2.0	36 X 2.0
	IA-20CC-22-35		30 X 2.0	45 X 2.0
	IA-20CC-22-42		30 X 2.0	52 X 2.0
	IA-20CC-28-35		36 X 2.0	45 X 2.0
	IA-20CC-28-42		36 X 2.0	52 X 2.0
	IA-20CC-35-18		45 X 2.0	26 X 1.5
	IA-20CC-35-42		45 X 2.0	52 X 2.0
	IA-20CC-42-28		52 X 2.0	36 X 2.0
	IA-20DD-06-06	S	14 X 1.5	14 X 1.5
	IA-20DD-06-08		14 X 1.5	16 X 1.5
	IA-20DD-06-10		14 X 1.5	18 X 1.5
	IA-20DD-06-12		14 X 1.5	20 X 1.5
	IA-20DD-06-14		14 X 1.5	22 X 1.5

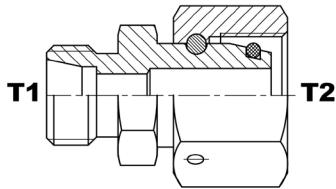

*Note: All Male DIN types include metric tube nut and metric bite sleeve.

*Note: All Female DIN Swivels are DKO Type.



WARNING This product can expose you to chemicals, which are known to the State of California to cause cancer or birth defects or other reproductive harm. For more information visit <https://www.p65warnings.ca.gov/>

IA-20CC, 20DD

DIN L & S TUBE REDUCER / INCREASER

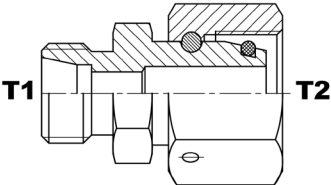
	PART NUMBER		T1	T2
	IA-20DD-06-16	S	14 X 1.5	24 X 1.5
	IA-20DD-06-20		14 X 1.5	30 X 2.0
	IA-20DD-06-25		14 X 1.5	36 X 2.0
	IA-20DD-06-30		14 X 1.5	42 X 2.0
	IA-20DD-06-38		14 X 1.5	52 X 2.0
	IA-20DD-08-10		16 X 1.5	18 X 1.5
	IA-20DD-08-12		16 X 1.5	20 X 1.5
	IA-20DD-08-14		16 X 1.5	22 X 1.5
	IA-20DD-08-16		16 X 1.5	24 X 1.5
	IA-20DD-08-20		16 X 1.5	30 X 2.0
	IA-20DD-08-25		16 X 1.5	36 X 2.0
	IA-20DD-08-30		16 X 1.5	42 X 2.0
	IA-20DD-08-38		16 X 1.5	52 X 2.0
	IA-20DD-10-10		18 X 1.5	18 X 1.5
	IA-20DD-10-12		18 X 1.5	20 X 1.5
	IA-20DD-10-14		18 X 1.5	22 X 1.5
	IA-20DD-10-16		18 X 1.5	24 X 1.5
	IA-20DD-10-20		18 X 1.5	30 X 2.0
	IA-20DD-10-25		18 X 1.5	36 X 2.0
	IA-20DD-10-30		18 X 1.5	42 X 2.0
	IA-20DD-10-38		18 X 1.5	52 X 2.0
	IA-20DD-12-14		20 X 1.5	22 X 1.5
	IA-20DD-12-16		20 X 1.5	24 X 1.5
	IA-20DD-12-20		20 X 1.5	30 X 2.0
	IA-20DD-12-25		20 X 1.5	36 X 2.0
	IA-20DD-12-30		20 X 1.5	42 X 2.0
	IA-20DD-12-38		20 X 1.5	52 X 2.0
	IA-20DD-14-16		22 X 1.5	24 X 1.5
	IA-20DD-14-20		22 X 1.5	30 X 2.0
	IA-20DD-14-25		22 X 1.5	36 X 2.0
	IA-20DD-14-30		22 X 1.5	42 X 2.0
	IA-20DD-14-38		22 X 1.5	52 X 2.0
	IA-20DD-16-10		24 X 1.5	18 X 1.5
	IA-20DD-16-12		24 X 1.5	20 X 1.5
	IA-20DD-16-16		24 X 1.5	24 X 1.5
	IA-20DD-16-20		24 X 1.5	30 X 2.0
	IA-20DD-16-25		24 X 1.5	36 X 2.0
	IA-20DD-16-30		24 X 1.5	42 X 2.0
	IA-20DD-16-38		24 X 1.5	52 X 2.0
	IA-20DD-20-20		30 X 2.0	30 X 2.0
IA-20DD-20-25	30 X 2.0	36 X 2.0		
IA-20DD-20-30	30 X 2.0	42 X 2.0		
IA-20DD-20-38	30 X 2.0	52 X 2.0		
IA-20DD-25-16	36 X 2.0	24 X 1.5		
IA-20DD-25-30	36 X 2.0	42 X 2.0		
IA-20DD-25-38	36 X 2.0	52 X 2.0		
IA-20DD-30-38	42 X 2.0	52 X 2.0		

*Note: All Male DIN types include metric tube nut and metric bite sleeve.

*Note: All Female DIN Swivels are DKO Type.

DIN BITE-TYPE 12° SEAT



WARNING This product can expose you to chemicals, which are known to the State of California to cause cancer or birth defects or other reproductive harm. For more information visit <https://www.p65warnings.ca.gov/>



IA-29CC, 29DD

90° DIN L & S FEMALE SWIVEL

PART NUMBER		T1	T2
		IA-29CC-06-06	12 X 1.5
IA-29CC-08-08		14 X 1.5	14 X 1.5
IA-29CC-10-10		16 X 1.5	16 X 1.5
IA-29CC-12-12		18 X 1.5	18 X 1.5
IA-29CC-15-15		22 X 1.5	22 X 1.5
IA-29CC-18-18		26 X 1.5	26 X 1.5
IA-29CC-22-22		30 X 2.0	30 X 2.0
IA-29CC-28-28		36 X 2.0	36 X 2.0
IA-29CC-35-35		45 X 2.0	45 X 2.0
IA-29CC-42-42		52 X 2.0	52 X 2.0
IA-29DD-06-06		14 X 1.5	14 X 1.5
IA-29DD-08-08		16 X 1.5	16 X 1.5
IA-29DD-10-10		18 X 1.5	18 X 1.5
IA-29DD-12-12		20 X 1.5	20 X 1.5
IA-29DD-14-14		22 X 1.5	22 X 1.5
IA-29DD-16-16		24 X 1.5	24 X 1.5
IA-29DD-20-20		30 X 2.0	30 X 2.0
IA-29DD-25-25		36 X 2.0	36 X 2.0
IA-29DD-30-30		42 X 2.0	42 X 2.0
IA-29DD-38-38		52 X 2.0	52 X 2.0

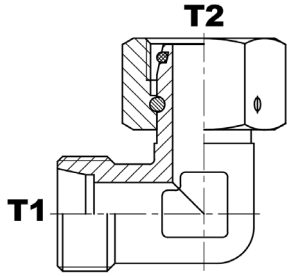

*Note: All Male DIN types include metric tube nut and metric bite sleeve.

*Note: All Female DIN Swivels are DKO Type.

IA-BCCC, BDDD

DIN L & S FEMALE SWIVEL BR. TEE

PART NUMBER		T1	T2	T3
		IA-BCCC-06-06-06	12 X 1.5	12 X 1.5
IA-BCCC-08-08-08		14 X 1.5	14 X 1.5	14 X 1.5
IA-BCCC-10-10-10		16 X 1.5	16 X 1.5	16 X 1.5
IA-BCCC-12-12-12		18 X 1.5	18 X 1.5	18 X 1.5
IA-BCCC-15-15-15		22 X 1.5	22 X 1.5	22 X 1.5
IA-BCCC-18-18-18		26 X 1.5	26 X 1.5	26 X 1.5
IA-BCCC-22-22-22		30 X 2.0	30 X 2.0	30 X 2.0
IA-BCCC-28-28-28		36 X 2.0	36 X 2.0	36 X 2.0
IA-BCCC-35-35-35		45 X 2.0	45 X 2.0	45 X 2.0
IA-BCCC-42-42-42		52 X 2.0	52 X 2.0	52 X 2.0
IA-BDDD-06-06-06		14 X 1.5	14 X 1.5	14 X 1.5
IA-BDDD-08-08-08		16 X 1.5	16 X 1.5	16 X 1.5
IA-BDDD-10-10-10		18 X 1.5	18 X 1.5	18 X 1.5
IA-BDDD-12-12-12		20 X 1.5	20 X 1.5	20 X 1.5
IA-BDDD-14-14-14		22 X 1.5	22 X 1.5	22 X 1.5
IA-BDDD-16-16-16		24 X 1.5	24 X 1.5	24 X 1.5
IA-BDDD-20-20-20		30 X 2.0	30 X 2.0	30 X 2.0
IA-BDDD-25-25-25		36 X 2.0	36 X 2.0	36 X 2.0
IA-BDDD-30-30-30		42 X 2.0	42 X 2.0	42 X 2.0
IA-BDDD-38-38-38		52 X 2.0	52 X 2.0	52 X 2.0

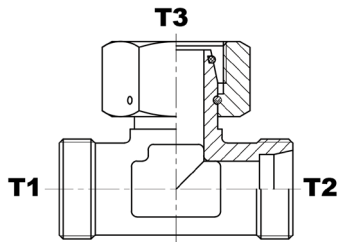

*Note: All Male DIN types include metric tube nut and metric bite sleeve.

*Note: All Female DIN Swivels are DKO Type.



WARNING This product can expose you to chemicals, which are known to the State of California to cause cancer or birth defects or other reproductive harm. For more information visit <https://www.p65warnings.ca.gov/>

IA-CCCC, CDDD

DIN L & S FEMALE SWIVEL RUN TEE

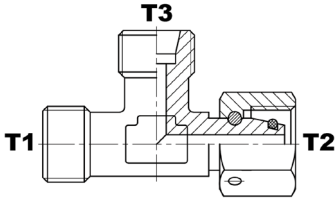

PART NUMBER		T1	T2	T3	
IA-CCCC-06-06-06	L	12 X 1.5	12 X 1.5	12 X 1.5	
IA-CCCC-08-08-08		14 X 1.5	14 X 1.5	14 X 1.5	
IA-CCCC-10-10-10		16 X 1.5	16 X 1.5	16 X 1.5	
IA-CCCC-12-12-12		18 X 1.5	18 X 1.5	18 X 1.5	
IA-CCCC-15-15-15		22 X 1.5	22 X 1.5	22 X 1.5	
IA-CCCC-18-18-18		26 X 1.5	26 X 1.5	26 X 1.5	
IA-CCCC-22-22-22		30 X 2.0	30 X 2.0	30 X 2.0	
IA-CCCC-28-28-28		36 X 2.0	36 X 2.0	36 X 2.0	
IA-CCCC-35-35-35		45 X 2.0	45 X 2.0	45 X 2.0	
IA-CCCC-42-42-42		52 X 2.0	52 X 2.0	52 X 2.0	
IA-CDDD-06-06-06		S	14 X 1.5	14 X 1.5	14 X 1.5
IA-CDDD-08-08-08			16 X 1.5	16 X 1.5	16 X 1.5
IA-CDDD-10-10-10	18 X 1.5		18 X 1.5	18 X 1.5	
IA-CDDD-12-12-12	20 X 1.5		20 X 1.5	20 X 1.5	
IA-CDDD-14-14-14	22 X 1.5		22 X 1.5	22 X 1.5	
IA-CDDD-16-16-16	24 X 1.5		24 X 1.5	24 X 1.5	
IA-CDDD-20-20-20	30 X 2.0		30 X 2.0	30 X 2.0	
IA-CDDD-25-25-25	36 X 2.0		36 X 2.0	36 X 2.0	
IA-CDDD-30-30-30	42 X 2.0		42 X 2.0	42 X 2.0	
IA-CDDD-38-38-38	52 X 2.0		52 X 2.0	52 X 2.0	

*Note: All Male DIN types include metric tube nut and metric bite sleeve.

*Note: All Female DIN Swivels are DKO Type.

IA-30CC, 30DD

DIN L & S FEMALE SWIVEL UNION

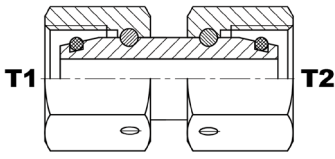

PART NUMBER		T1	T2
IA-30CC-06-06	L	12 X 1.5	12 X 1.5
IA-30CC-08-08		14 X 1.5	14 X 1.5
IA-30CC-10-10		16 X 1.5	16 X 1.5
IA-30CC-12-12		18 X 1.5	18 X 1.5
IA-30CC-15-12		22 X 1.5	18 X 1.5
IA-30CC-15-15		22 X 1.5	22 X 1.5
IA-30CC-18-18		26 X 1.5	26 X 1.5
IA-30CC-22-22		30 X 2.0	30 X 2.0
IA-30CC-28-28		36 X 2.0	36 X 2.0
IA-30CC-35-35		45 X 2.0	45 X 2.0
IA-30CC-42-42		52 X 2.0	52 X 2.0
IA-30DD-06-06		S	14 X 1.5
IA-30DD-08-08	16 X 1.5		16 X 1.5
IA-30DD-10-10	18 X 1.5		18 X 1.5
IA-30DD-12-06	20 X 1.5		14 X 1.5
IA-30DD-12-10	20 X 1.5		18 X 1.5
IA-30DD-12-12	20 X 1.5		20 X 1.5
IA-30DD-14-14	22 X 1.5		22 X 1.5
IA-30DD-16-16	24 X 1.5		24 X 1.5
IA-30DD-20-16	30 X 2.0		24 X 1.5
IA-30DD-20-20	30 X 2.0		30 X 2.0
IA-30DD-25-25	36 X 2.0		36 X 2.0
IA-30DD-30-25	42 X 2.0		36 X 2.0
IA-30DD-30-30	42 X 2.0	42 X 2.0	
IA-30DD-38-38	52 X 2.0	52 X 2.0	

*Note: All Male DIN types include metric tube nut and metric bite sleeve.

*Note: All Female DIN Swivels are DKO Type.



WARNING This product can expose you to chemicals, which are known to the State of California to cause cancer or birth defects or other reproductive harm. For more information visit <https://www.p65warnings.ca.gov/>



IA-10AB, 10CB, 10DB-WD DIN LL, L & S BSPP MALE W/ SEAL

	PART NUMBER		T1	T2	
	IA-10CB-06-02-WD	L	12 X 1.5	1/8 - 28	
	IA-10CB-06-04-WD		12 X 1.5	1/4 - 19	
	IA-10CB-06-06-WD		12 X 1.5	3/8 - 19	
	IA-10CB-08-02-WD		14 X 1.5	1/8 - 28	
	IA-10CB-08-04-WD		14 X 1.5	1/4 - 19	
	IA-10CB-08-06-WD		14 X 1.5	3/8 - 19	
	IA-10CB-08-08-WD		14 X 1.5	1/2 - 14	
	IA-10CB-10-02-WD		16 X 1.5	1/8 - 28	
	IA-10CB-10-04-WD		16 X 1.5	1/4 - 19	
	IA-10CB-10-06-WD		16 X 1.5	3/8 - 19	
	IA-10CB-10-08-WD		16 X 1.5	1/2 - 14	
	IA-10CB-12-02-WD		18 X 1.5	1/8 - 28	
	IA-10CB-12-04-WD		18 X 1.5	1/4 - 19	
	IA-10CB-12-06-WD		18 X 1.5	3/8 - 19	
	IA-10CB-12-08-WD		18 X 1.5	1/2 - 14	
	IA-10CB-15-06-WD		22 X 1.5	3/8 - 19	
	IA-10CB-15-08-WD		22 X 1.5	1/2 - 14	
	IA-10CB-15-12-WD		22 X 1.5	3/4 - 14	
	IA-10CB-18-06-WD		26 X 1.5	3/8 - 19	
	IA-10CB-18-08-WD		26 X 1.5	1/2 - 14	
	IA-10CB-18-12-WD		26 X 1.5	3/4 - 14	
	IA-10CB-22-08-WD		30 X 2.0	1/2 - 14	
	IA-10CB-22-12-WD		30 X 2.0	3/4 - 14	
	IA-10CB-28-12-WD		36 X 2.0	3/4 - 14	
	IA-10CB-28-16-WD		36 X 2.0	1 - 11	
	IA-10CB-28-20-WD		36 X 2.0	1 1/4 - 11	
	IA-10CB-35-16-WD		45 X 2.0	1 - 11	
	IA-10CB-35-20-WD		45 X 2.0	1 1/4 - 11	
	IA-10CB-35-24-WD		45 X 2.0	1 1/2 - 11	
	IA-10CB-42-24-WD		52 X 2.0	1 1/2 - 11	
	IA-10DB-06-04-WD		S	14 X 1.5	1/4 - 19
	IA-10DB-08-04-WD			16 X 1.5	1/4 - 19
IA-10DB-08-06-WD	16 X 1.5	3/8 - 19			
IA-10DB-10-04-WD	18 X 1.5	1/4 - 19			
IA-10DB-10-06-WD	18 X 1.5	3/8 - 19			
IA-10DB-10-08-WD	18 X 1.5	1/2 - 14			
IA-10DB-12-04-WD	20 X 1.5	1/4 - 19			
IA-10DB-12-06-WD	20 X 1.5	3/8 - 19			
IA-10DB-12-08-WD	20 X 1.5	1/2 - 14			
IA-10DB-14-08-WD	22 X 1.5	1/2 - 14			
IA-10DB-16-06-WD	24 X 1.5	3/8 - 19			
IA-10DB-16-08-WD	24 X 1.5	1/2 - 14			
IA-10DB-16-12-WD	24 X 1.5	3/4 - 14			
IA-10DB-20-08-WD	30 X 2.0	1/2 - 14			
IA-10DB-20-12-WD	30 X 2.0	3/4 - 14			
IA-10DB-20-16-WD	30 X 2.0	1 - 11			
IA-10DB-25-08-WD	36 X 2.0	1/2 - 14			
IA-10DB-25-12-WD	36 X 2.0	3/4 - 14			
IA-10DB-25-16-WD	36 X 2.0	1 - 11			
IA-10DB-25-20-WD	36 X 2.0	1 1/4 - 11			
IA-10DB-30-16-WD	42 X 2.0	1 - 11			
IA-10DB-30-20-WD	42 X 2.0	1 1/4 - 11			
IA-10DB-30-24-WD	42 X 2.0	1 1/2 - 11			
IA-10DB-38-24-WD	52 X 2.0	1 1/2 - 11			

*Note: All Male DIN types include metric tube nut and metric bite sleeve.

*Note: All Female DIN Swivels are DKO Type.



WARNING This product can expose you to chemicals, which are known to the State of California to cause cancer or birth defects or other reproductive harm. For more information visit <https://www.p65warnings.ca.gov/>

IA-14CG, 14DG

DIN L & S x 45° BSPP MALE ADJ.

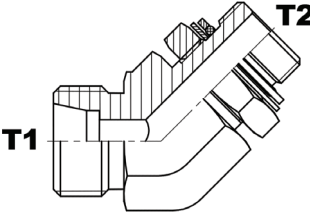

PART NUMBER		T1	T2
IA-14CG-06-02	L	12 X 1.5	1/8 - 28
IA-14CG-08-04		14 X 1.5	1/4 - 19
IA-14CG-10-04		16 X 1.5	1/4 - 19
IA-14CG-12-06		18 X 1.5	3/8 - 19
IA-14CG-15-08		22 X 1.5	1/2 - 14
IA-14CG-18-08		26 X 1.5	1/2 - 14
IA-14CG-18-12		26 X 1.5	3/4 - 14
IA-14CG-22-12		30 X 2.0	3/4 - 14
IA-14CG-28-16		36 X 2.0	1 - 11
IA-14CG-35-20		45 X 2.0	1 1/4 - 11
IA-14DG-06-04	S	14 X 1.5	1/4 - 19
IA-14DG-08-04		16 X 1.5	1/4 - 19
IA-14DG-10-06		18 X 1.5	3/8 - 19
IA-14DG-12-06		20 X 1.5	3/8 - 19
IA-14DG-14-08		22 X 1.5	1/2 - 14
IA-14DG-16-08		24 X 1.5	1/2 - 14
IA-14DG-20-12		30 X 2.0	3/4 - 14
IA-14DG-25-16		36 X 2.0	1 - 11
IA-14DG-30-20		42 X 2.0	1 1/4 - 11

*Note: All Male DIN types include metric tube nut and metric bite sleeve.

*Note: All Female DIN Swivels are DKO Type.

IA-19CG, 19DG

DIN L & S x 90° BSPP MALE ADJ.

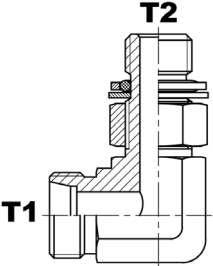

PART NUMBER		T1	T2
IA-19CG-06-02	L	12 X 1.5	1/8 - 28
IA-19CG-08-04		14 X 1.5	1/4 - 19
IA-19CG-10-04		16 X 1.5	1/4 - 19
IA-19CG-10-06		16 X 1.5	3/8 - 19
IA-19CG-12-04		18 X 1.5	1/4 - 19
IA-19CG-12-06		18 X 1.5	3/8 - 19
IA-19CG-12-08		18 X 1.5	1/2 - 14
IA-19CG-15-08		22 X 1.5	1/2 - 14
IA-19CG-18-08		26 X 1.5	1/2 - 14
IA-19CG-18-12		26 X 1.5	3/4 - 14
IA-19CG-22-12		30 X 2.0	3/4 - 14
IA-19CG-28-16		36 X 2.0	1 - 11
IA-19CG-35-20		45 X 2.0	1 1/4 - 11
IA-19CG-42-24		52 X 2.0	1 1/2 - 11
IA-19DG-06-04	S	14 X 1.5	1/4 - 19
IA-19DG-08-04		16 X 1.5	1/4 - 19
IA-19DG-10-06		18 X 1.5	3/8 - 19
IA-19DG-12-06		20 X 1.5	3/8 - 19
IA-19DG-12-08		20 X 1.5	1/2 - 14
IA-19DG-14-08		22 X 1.5	1/2 - 14
IA-19DG-16-06		24 X 1.5	3/8 - 19
IA-19DG-16-08		24 X 1.5	1/2 - 14
IA-19DG-20-12		30 X 2.0	3/4 - 14
IA-19DG-25-12		36 X 2.0	3/4 - 14
IA-19DG-25-16		36 X 2.0	1 - 11
IA-19DG-30-20		42 X 2.0	1 1/4 - 11
IA-19DG-38-24		52 X 2.0	1 1/2 - 11

*Note: All Male DIN types include metric tube nut and metric bite sleeve.

*Note: All Female DIN Swivels are DKO Type.



WARNING This product can expose you to chemicals, which are known to the State of California to cause cancer or birth defects or other reproductive harm. For more information visit <https://www.p65warnings.ca.gov/>





IA-ACCG, ADDG

DIN L & S x BSPP MALE ADJ. BR. TEE

PART NUMBER		T1	T2	T3
		IA-ACCG-06-06-02	L	12 X 1.5
IA-ACCG-08-08-04	14 X 1.5	14 X 1.5		1/4 - 19
IA-ACCG-10-10-04	16 X 1.5	16 X 1.5		1/4 - 19
IA-ACCG-12-12-06	18 X 1.5	18 X 1.5		3/8 - 19
IA-ACCG-15-15-08	22 X 1.5	22 X 1.5		1/2 - 14
IA-ACCG-18-18-08	26 X 1.5	26 X 1.5		1/2 - 14
IA-ACCG-22-22-12	30 X 2.0	30 X 2.0		3/4 - 14
IA-ACCG-28-28-16	36 X 2.0	36 X 2.0		1 - 11
IA-ACCG-35-35-20	45 X 2.0	45 X 2.0		1 1/4 - 11
IA-ADDG-06-06-04	S	14 X 1.5		14 X 1.5
IA-ADDG-08-08-04		16 X 1.5	16 X 1.5	1/4 - 19
IA-ADDG-10-10-06		18 X 1.5	18 X 1.5	3/8 - 19
IA-ADDG-12-12-06		20 X 1.5	20 X 1.5	3/8 - 19
IA-ADDG-14-14-08		22 X 1.5	22 X 1.5	1/2 - 14
IA-ADDG-16-16-08		24 X 1.5	24 X 1.5	1/2 - 14
IA-ADDG-20-20-12		30 X 2.0	30 X 2.0	3/4 - 14
IA-ADDG-25-25-16		36 X 2.0	36 X 2.0	1 - 11
IA-ADDG-30-30-20		42 X 2.0	42 X 2.0	1 1/4 - 11
IA-ADDG-38-38-24		52 X 2.0	52 X 2.0	1 1/2 - 11

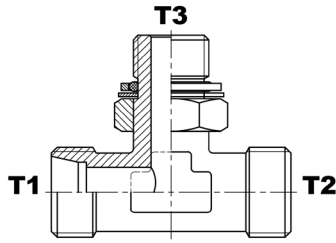

*Note: All Male DIN types include metric tube nut and metric bite sleeve.

*Note: All Female DIN Swivels are DKO Type.

IA-ACGC, ADGD

DIN L & S x BSPP MALE ADJ. RUN TEE

PART NUMBER		T1	T2	T3
		IA-ACGC-06-02-06	L	12 X 1.5
IA-ACGC-08-04-08	14 X 1.5	1/4 - 19		14 X 1.5
IA-ACGC-10-04-10	16 X 1.5	1/4 - 19		16 X 1.5
IA-ACGC-12-06-12	18 X 1.5	3/8 - 19		18 X 1.5
IA-ACGC-15-08-15	22 X 1.5	1/2 - 14		22 X 1.5
IA-ACGC-18-08-18	26 X 1.5	1/2 - 14		26 X 1.5
IA-ACGC-22-12-22	30 X 2.0	3/4 - 14		30 X 2.0
IA-ACGC-28-16-28	36 X 2.0	1 - 11		36 X 2.0
IA-ACGC-35-20-35	45 X 2.0	1 1/4 - 11		45 X 2.0
IA-ADGD-06-04-06	S	14 X 1.5		1/4 - 19
IA-ADGD-08-04-08		16 X 1.5	1/4 - 19	16 X 1.5
IA-ADGD-10-06-10		18 X 1.5	3/8 - 19	18 X 1.5
IA-ADGD-12-06-12		20 X 1.5	3/8 - 19	20 X 1.5
IA-ADGD-14-08-14		22 X 1.5	1/2 - 14	22 X 1.5
IA-ADGD-16-08-16		24 X 1.5	1/2 - 14	24 X 1.5
IA-ADGD-20-12-20		30 X 2.0	3/4 - 14	30 X 2.0
IA-ADGD-25-16-25		36 X 2.0	1 - 11	36 X 2.0
IA-ADGD-30-20-30		42 X 2.0	1 1/4 - 11	42 X 2.0

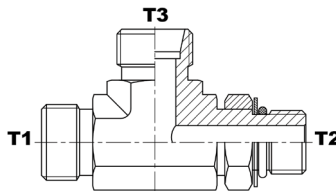

*Note: All Male DIN types include metric tube nut and metric bite sleeve.

*Note: All Female DIN Swivels are DKO Type.



WARNING This product can expose you to chemicals, which are known to the State of California to cause cancer or birth defects or other reproductive harm. For more information visit <https://www.p65warnings.ca.gov/>

IA-20BC-WD, 20BD-WD BSPP MALE W/ SEAL x DIN L & S FEM. SWIVEL

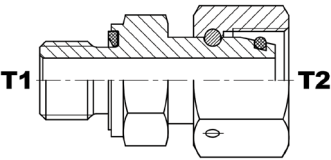

PART NUMBER		T1	T2	
IA-20BC-02-06-WD	L	1/8 - 28	12 X 1.5	
IA-20BC-04-08-WD		1/4 - 19	14 X 1.5	
IA-20BC-04-10-WD		1/4 - 19	16 X 1.5	
IA-20BC-04-12-WD		1/4 - 19	18 X 1.5	
IA-20BC-04-15-WD		1/4 - 19	22 X 1.5	
IA-20BC-06-10-WD		3/8 - 19	16 X 1.5	
IA-20BC-06-12-WD		3/8 - 19	18 X 1.5	
IA-20BC-08-12-WD		1/2 - 14	18 X 1.5	
IA-20BC-08-15-WD		1/2 - 14	22 X 1.5	
IA-20BC-08-18-WD		1/2 - 14	26 X 1.5	
IA-20BC-12-22-WD		3/4 - 14	30 X 2.0	
IA-20BC-16-28-WD		1 - 11	36 X 2.0	
IA-20BC-20-35-WD		1 1/4 - 11	45 X 2.0	
IA-20BC-24-42-WD		1 1/2 - 11	52 X 2.0	
IA-20BD-04-06-WD		S	1/4 - 19	14 X 1.5
IA-20BD-04-08-WD			1/4 - 19	16 X 1.5
IA-20BD-06-10-WD	3/8 - 19		18 X 1.5	
IA-20BD-06-12-WD	3/8 - 19		20 X 1.5	
IA-20BD-08-12-WD	1/2 - 14		20 X 1.5	
IA-20BD-08-14-WD	1/2 - 14		22 X 1.5	
IA-20BD-08-16-WD	1/2 - 14		24 X 1.5	
IA-20BD-12-16-WD	3/4 - 14		24 X 1.5	
IA-20BD-12-20-WD	3/4 - 14		30 X 2.0	
IA-20BD-12-25-WD	3/4 - 14		36 X 2.0	
IA-20BD-16-25-WD	1 - 11		36 X 2.0	
IA-20BD-16-30-WD	1 - 11		42 X 2.0	
IA-20BD-20-30-WD	1 1/4 - 11		42 X 2.0	

*Note: All Male DIN types include metric tube nut and metric bite sleeve.

*Note: All Female DIN Swivels are DKO Type.



DIN BITE-TYPE 12° SEAT



WARNING This product can expose you to chemicals, which are known to the State of California to cause cancer or birth defects or other reproductive harm. For more information visit <https://www.p65warnings.ca.gov/>



IA-50CB, 50DB DIN L & S x BSPP FEMALE RIGID

	PART NUMBER		T1	T2	
	IA-50CB-06-02	L	12 X 1.5	1/8 - 28	
	IA-50CB-06-04		12 X 1.5	1/4 - 19	
	IA-50CB-08-04		14 X 1.5	1/4 - 19	
	IA-50CB-08-06		14 X 1.5	3/8 - 19	
	IA-50CB-08-08		14 X 1.5	1/2 - 14	
	IA-50CB-10-04		16 X 1.5	1/4 - 19	
	IA-50CB-10-06		16 X 1.5	3/8 - 19	
	IA-50CB-10-08		16 X 1.5	1/2 - 14	
	IA-50CB-12-04		18 X 1.5	1/4 - 19	
	IA-50CB-12-06		18 X 1.5	3/8 - 19	
	IA-50CB-12-08		18 X 1.5	1/2 - 14	
	IA-50CB-15-06		22 X 1.5	3/8 - 19	
	IA-50CB-15-08		22 X 1.5	1/2 - 14	
	IA-50CB-18-08		26 X 1.5	1/2 - 14	
	IA-50CB-22-12		30 X 2.0	3/4 - 14	
	IA-50CB-28-16		36 X 2.0	1 - 11	
	IA-50CB-35-20		45 X 2.0	1 1/4 - 11	
	IA-50CB-42-24		52 X 2.0	1 1/2 - 11	
	IA-50DB-06-04		S	14 X 1.5	1/4 - 19
	IA-50DB-08-04			16 X 1.5	1/4 - 19
IA-50DB-10-06	18 X 1.5	3/8 - 19			
IA-50DB-12-06	20 X 1.5	3/8 - 19			
IA-50DB-12-08	20 X 1.5	1/2 - 14			
IA-50DB-14-08	22 X 1.5	1/2 - 14			
IA-50DB-16-06	24 X 1.5	3/8 - 19			
IA-50DB-16-08	24 X 1.5	1/2 - 14			
IA-50DB-20-12	30 X 2.0	3/4 - 14			
IA-50DB-25-16	36 X 2.0	1 - 11			
IA-50DB-30-20	42 X 2.0	1 1/4 - 11			
IA-50DB-38-24	52 X 2.0	1 1/2 - 11			

*Note: All Male DIN types include metric tube nut and metric bite sleeve.

*Note: All Female DIN Swivels are DKO Type.



WARNING This product can expose you to chemicals, which are known to the State of California to cause cancer or birth defects or other reproductive harm. For more information visit <https://www.p65warnings.ca.gov/>

IA-10AT, 10CT, 10DT

DIN L & S x BSPT MALE

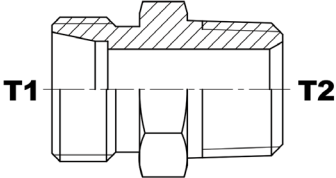
	PART NUMBER		T1	T2
	IA-10CT-06-02	L	12 X 1.5	1/8 - 28
	IA-10CT-06-04		12 X 1.5	1/4 - 19
	IA-10CT-08-02		14 X 1.5	1/8 - 28
	IA-10CT-08-04		14 X 1.5	1/4 - 19
	IA-10CT-08-06		14 X 1.5	3/8 - 19
	IA-10CT-10-04		16 X 1.5	1/4 - 19
	IA-10CT-10-06		16 X 1.5	3/8 - 19
	IA-10CT-10-08		16 X 1.5	1/2 - 14
	IA-10CT-12-04		18 X 1.5	1/4 - 19
	IA-10CT-12-06		18 X 1.5	3/8 - 19
	IA-10CT-12-08		18 X 1.5	1/2 - 14
	IA-10CT-15-06		22 X 1.5	3/8 - 19
	IA-10CT-15-08		22 X 1.5	1/2 - 14
	IA-10CT-18-08		26 X 1.5	1/2 - 14
	IA-10CT-18-12		26 X 1.5	3/4 - 14
	IA-10CT-22-12		30 X 2.0	3/4 - 14
	IA-10CT-28-16		36 X 2.0	1 - 11
	IA-10CT-35-20		45 X 2.0	1 1/4 - 11
	IA-10CT-42-24		52 X 2.0	1 1/2 - 11
				S
IA-10DT-06-02	14 X 1.5	1/8 - 28		
IA-10DT-06-04	14 X 1.5	1/4 - 19		
IA-10DT-08-04	16 X 1.5	1/4 - 19		
IA-10DT-10-04	18 X 1.5	1/4 - 19		
IA-10DT-10-06	18 X 1.5	3/8 - 19		
IA-10DT-12-04	20 X 1.5	1/4 - 19		
IA-10DT-12-06	20 X 1.5	3/8 - 19		
IA-10DT-12-08	20 X 1.5	1/2 - 14		
IA-10DT-14-08	22 X 1.5	1/2 - 14		
IA-10DT-16-08	24 X 1.5	1/2 - 14		
IA-10DT-20-12	30 X 2.0	3/4 - 14		
IA-10DT-20-16	30 X 2.0	1 - 11		
IA-10DT-25-16	36 X 2.0	1 - 11		
IA-10DT-30-20	42 X 2.0	1 1/4 - 11		
IA-10DT-38-24	52 X 2.0	1 1/2 - 11		

*Note: All Male DIN types include metric tube nut and metric bite sleeve.

*Note: All Female DIN Swivels are DKO Type.



IA-19AT, 19CT, 19DT

DIN L & S x 90° BSPT MALE

PART NUMBER		T1	T2		
				12 X 1.5	1/8 - 28
14 X 1.5	1/4 - 19				
16 X 1.5	1/4 - 19				
18 X 1.5	3/8 - 19				
22 X 1.5	1/2 - 14				
26 X 1.5	1/2 - 14				
30 X 2.0	3/4 - 14				
36 X 2.0	1 - 11				
45 X 2.0	1 1/4 - 11				
52 X 2.0	1 1/2 - 11				
				14 X 1.5	1/4 - 19
				16 X 1.5	1/4 - 19
		18 X 1.5	3/8 - 19		
		20 X 1.5	3/8 - 19		
		22 X 1.5	1/2 - 14		
		24 X 1.5	1/2 - 14		
		30 X 2.0	3/4 - 14		
		36 X 2.0	3/4 - 14		
		36 X 2.0	1 - 11		
		42 X 2.0	1 1/4 - 11		
		52 X 2.0	1 1/2 - 11		

*Note: All Male DIN types include metric tube nut and metric bite sleeve.

*Note: All Female DIN Swivels are DKO Type.



WARNING This product can expose you to chemicals, which are known to the State of California to cause cancer or birth defects or other reproductive harm. For more information visit <https://www.p65warnings.ca.gov/>

IA-10CM-WD, 10DM-WD

DIN L & S x METRIC PORT MALE

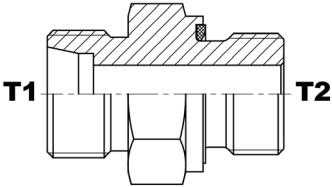
	PART NUMBER		T1	T2
	IA-10CM-06-10-WD	L	12 X 1.5	10 X 1.0
	IA-10CM-06-12-WD		12 X 1.5	12 X 1.5
	IA-10CM-08-10-WD		14 X 1.5	10 X 1.0
	IA-10CM-08-12-WD		14 X 1.5	12 X 1.5
	IA-10CM-08-14-WD		14 X 1.5	14 X 1.5
	IA-10CM-08-16-WD		14 X 1.5	16 X 1.5
	IA-10CM-10-10-WD		16 X 1.5	10 X 1.0
	IA-10CM-10-12-WD		16 X 1.5	12 X 1.5
	IA-10CM-10-14-WD		16 X 1.5	14 X 1.5
	IA-10CM-10-16-WD		16 X 1.5	16 X 1.5
	IA-10CM-10-18-WD		16 X 1.5	18 X 1.5
	IA-10CM-12-12-WD		18 X 1.5	12 X 1.5
	IA-10CM-12-14-WD		18 X 1.5	14 X 1.5
	IA-10CM-12-16-WD		18 X 1.5	16 X 1.5
	IA-10CM-12-18-WD		18 X 1.5	18 X 1.5
	IA-10CM-12-22-WD		18 X 1.5	22 X 1.5
	IA-10CM-15-18-WD		22 X 1.5	18 X 1.5
	IA-10CM-15-22-WD		22 X 1.5	22 X 1.5
	IA-10CM-18-18-WD		26 X 1.5	18 X 1.5
	IA-10CM-18-22-WD		26 X 1.5	22 X 1.5
	IA-10CM-22-26-WD		30 X 2.0	26 X 1.5
	IA-10CM-22-27-WD		30 X 2.0	27 X 2.0
	IA-10CM-28-33-WD		36 X 2.0	33 X 2.0
	IA-10CM-35-42-WD	45 X 2.0	42 X 2.0	
	IA-10CM-42-48-WD	52 X 2.0	48 X 2.0	
	IA-10DM-06-12-WD	S	14 X 1.5	12 X 1.5
	IA-10DM-08-14-WD		16 X 1.5	14 X 1.5
	IA-10DM-10-16-WD		18 X 1.5	16 X 1.5
	IA-10DM-12-18-WD		20 X 1.5	18 X 1.5
	IA-10DM-14-20-WD		22 X 1.5	20 X 1.5
	IA-10DM-16-22-WD		24 X 1.5	22 X 1.5
	IA-10DM-20-27-WD		30 X 2.0	27 X 2.0
	IA-10DM-25-33-WD		36 X 2.0	33 X 2.0
IA-10DM-30-42-WD	42 X 2.0		42 X 2.0	
IA-10DM-38-48-WD	52 X 2.0		48 X 2.0	

*Note: All Male DIN types include metric tube nut and metric bite sleeve.
 *Note: All Female DIN Swivels are DKO Type.

DIN BITE-TYPE 12° SEAT



WARNING This product can expose you to chemicals, which are known to the State of California to cause cancer or birth defects or other reproductive harm. For more information visit <https://www.p65warnings.ca.gov/>



IA-50CM, 50DM

DIN L & S x METRIC FEMALE

	PART NUMBER		T1	T2
	IA-50CM-06-10	L	12 X 1.5	10 X 1.0
	IA-50CM-08-12		14 X 1.5	12 X 1.5
	IA-50CM-10-14		16 X 1.5	14 X 1.5
	IA-50CM-12-16		18 X 1.5	16 X 1.5
	IA-50CM-15-18		22 X 1.5	18 X 1.5
	IA-50CM-18-22		26 X 1.5	22 X 1.5
	IA-50CM-22-26		30 X 2.0	26 X 1.5
	IA-50CM-28-33		36 X 2.0	33 X 2.0
	IA-50CM-35-42		45 X 2.0	42 X 2.0
	IA-50CM-42-48		52 X 2.0	48 X 2.0
	PART NUMBER		T1	T2
	IA-50DM-06-12	S	14 X 1.5	12 X 1.5
	IA-50DM-08-14		16 X 1.5	14 X 1.5
	IA-50DM-10-16		18 X 1.5	16 X 1.5
	IA-50DM-12-18		20 X 1.5	18 X 1.5
	IA-50DM-14-20		22 X 1.5	20 X 1.5
	IA-50DM-16-22		24 X 1.5	22 X 1.5
	IA-50DM-20-27		30 X 2.0	27 X 2.0
	IA-50DM-25-33		36 X 2.0	33 X 2.0
	IA-50DM-30-42		42 X 2.0	42 X 2.0
IA-50DM-38-48	52 X 2.0		48 X 2.0	

*Note: All Male DIN types include metric tube nut and metric bite sleeve.

*Note: All Female DIN Swivels are DKO Type.

IA-19CH, 19DH

DIN L & S x 90° METRIC PORT ADJ. MALE

	PART NUMBER		T1	T2
	IA-19CH-06-10	L	12 X 1.5	10 X 1.0
	IA-19CH-08-12		14 X 1.5	12 X 1.5
	IA-19CH-10-14		16 X 1.5	14 X 1.5
	IA-19CH-12-16		18 X 1.5	16 X 1.5
IA-19CH-15-18	22 X 1.5		18 X 1.5	
	PART NUMBER		T1	T2
	IA-19DH-06-12	S	14 X 1.5	12 X 1.5
	IA-19DH-08-14		16 X 1.5	14 X 1.5
	IA-19DH-10-16		18 X 1.5	16 X 1.5
IA-19DH-12-18	20 X 1.5		18 X 1.5	

*Note: All Male DIN types include metric tube nut and metric bite sleeve.

*Note: All Female DIN Swivels are DKO Type.



WARNING This product can expose you to chemicals, which are known to the State of California to cause cancer or birth defects or other reproductive harm. For more information visit <https://www.p65warnings.ca.gov/>

IA-20MC-WD, 20MD-WD METRIC PORT MALE x DIN L & S SWIVEL

PART NUMBER		T1	T2
		IA-20MC-10-06-WD	L
IA-20MC-12-08-WD	12 X 1.5	14 X 1.5	
IA-20MC-14-10-WD	14 X 1.5	16 X 1.5	
IA-20MC-16-12-WD	16 X 1.5	18 X 1.5	
IA-20MC-18-15-WD	18 X 1.5	22 X 1.5	
IA-20MC-22-18-WD	22 X 1.5	26 X 1.5	
IA-20MC-26-22-WD	26 X 1.5	30 X 2.0	
IA-20MC-33-28-WD	33 X 2.0	36 X 2.0	
IA-20MC-42-35-WD	42 X 2.0	45 X 2.0	
IA-20MC-48-42-WD	48 X 2.0	52 X 2.0	
IA-20MD-12-06-WD	S	12 X 1.5	14 X 1.5
IA-20MD-14-08-WD		14 X 1.5	16 X 1.5
IA-20MD-16-10-WD		16 X 1.5	18 X 1.5
IA-20MD-18-12-WD		18 X 1.5	20 X 1.5
IA-20MD-20-14-WD		20 X 1.5	22 X 1.5
IA-20MD-22-16-WD		22 X 1.5	24 X 1.5
IA-20MD-33-25-WD		33 X 2.0	36 X 2.0
IA-20MD-42-30-WD		42 X 2.0	42 X 2.0
IA-20MD-48-38-WD		48 X 2.0	52 X 2.0

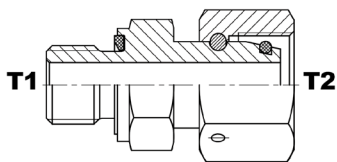

*Note: All Male DIN types include metric tube nut and metric bite sleeve.
 *Note: All Female DIN Swivels are DKO Type.

IA-10AI, 10CI DIN LL & L x METRIC TAPERED MALE

PART NUMBER		T1	T2
IA-10AI-04-06	LL	8 X 1.0	6 X 1.0
IA-10AI-04-08		8 X 1.0	8 X 1.0

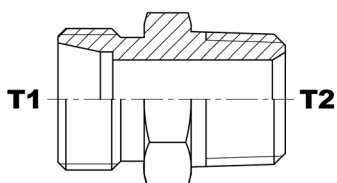

*Quoted Upon Request

*Note: All Male DIN types include metric tube nut and metric bite sleeve.
 *Note: All Female DIN Swivels are DKO Type.

IA-19AI, 19CI DIN LL & L x 90° METRIC TAPERED MALE

PART NUMBER		T1	T2
IA-19AI-06-10	LL	10 X 1.0	10 X 1.0
IA-19AI-08-10		12 X 1.0	10 X 1.0

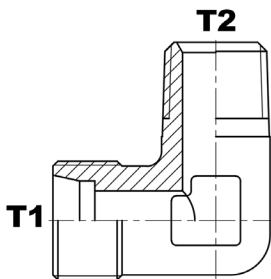

*Quoted Upon Request

*Note: All Male DIN types include metric tube nut and metric bite sleeve.
 *Note: All Female DIN Swivels are DKO Type.



IA-10AN, 10CN, 10DN DIN LL, L & S x NPT MALE

	PART NUMBER		T1	T2
	IA-10CN-06-02	L	12 X 1.5	1/8 - 27
	IA-10CN-06-04		12 X 1.5	1/4 - 18
	IA-10CN-08-02		14 X 1.5	1/8 - 27
	IA-10CN-08-04		14 X 1.5	1/4 - 18
	IA-10CN-10-04		16 X 1.5	1/4 - 18
	IA-10CN-10-06		16 X 1.5	3/8 - 18
	IA-10CN-12-04		18 X 1.5	1/4 - 18
	IA-10CN-12-06		18 X 1.5	3/8 - 18
	IA-10CN-12-08		18 X 1.5	1/2 - 14
	IA-10CN-15-08		22 X 1.5	1/2 - 14
	IA-10CN-15-12		22 X 1.5	3/4 - 14
	IA-10CN-18-08		26 X 1.5	1/2 - 14
	IA-10CN-18-12		26 X 1.5	3/4 - 14
	IA-10CN-22-08		30 X 2.0	1/2 - 14
	IA-10CN-22-12		30 X 2.0	3/4 - 14
	IA-10CN-22-16		30 X 2.0	1 - 11 1/2
	IA-10CN-28-12		36 X 2.0	3/4 - 14
	IA-10CN-28-16		36 X 2.0	1 - 11 1/2
	IA-10CN-28-20		36 X 2.0	1 1/4 - 11 1/2
	IA-10CN-35-20		45 X 2.0	1 1/4 - 11 1/2
IA-10CN-42-20	52 X 2.0	1 1/4 - 11 1/2		
IA-10CN-42-24	52 X 2.0	1 1/2 - 11 1/2		
IA-10DN-06-04	S	14 X 1.5	1/4 - 18	
IA-10DN-08-04		16 X 1.5	1/4 - 18	
IA-10DN-10-04		18 X 1.5	1/4 - 18	
IA-10DN-10-06		18 X 1.5	3/8 - 18	
IA-10DN-12-04		20 X 1.5	1/4 - 18	
IA-10DN-12-06		20 X 1.5	3/8 - 18	
IA-10DN-12-08		20 X 1.5	1/2 - 14	
IA-10DN-14-06		22 X 1.5	3/8 - 18	
IA-10DN-14-08		22 X 1.5	1/2 - 14	
IA-10DN-16-06		24 X 1.5	3/8 - 18	
IA-10DN-16-08		24 X 1.5	1/2 - 14	
IA-10DN-16-12		24 X 1.5	3/4 - 14	
IA-10DN-20-08		30 X 2.0	1/2 - 14	
IA-10DN-20-12		30 X 2.0	3/4 - 14	
IA-10DN-25-12		36 X 2.0	3/4 - 14	
IA-10DN-25-16		36 X 2.0	1 - 11 1/2	
IA-10DN-30-16		42 X 2.0	1 - 11 1/2	
IA-10DN-30-20		42 X 2.0	1 1/4 - 11 1/2	
IA-10DN-30-24		42 X 2.0	1 1/2 - 11 1/2	
IA-10DN-38-20		52 X 2.0	1 1/4 - 11 1/2	
IA-10DN-38-24	52 X 2.0	1 1/2 - 11 1/2		

*Note: All Male DIN types include metric tube nut and metric bite sleeve.

*Note: All Female DIN Swivels are DKO Type.



WARNING This product can expose you to chemicals, which are known to the State of California to cause cancer or birth defects or other reproductive harm. For more information visit <https://www.p65warnings.ca.gov/>

IA-19CN, 19DN

DIN L & S x 90° NPT MALE

PART NUMBER		T1	T2	
		IA-19CN-06-02	L	12 X 1.5
IA-19CN-06-04	12 X 1.5	1/4 - 18		
IA-19CN-08-02	14 X 1.5	1/8 - 27		
IA-19CN-08-04	14 X 1.5	1/4 - 18		
IA-19CN-10-04	16 X 1.5	1/4 - 18		
IA-19CN-10-06	16 X 1.5	3/8 - 18		
IA-19CN-12-04	18 X 1.5	1/4 - 18		
IA-19CN-12-06	18 X 1.5	3/8 - 18		
IA-19CN-15-08	22 X 1.5	1/2 - 14		
IA-19CN-18-12	26 X 1.5	3/4 - 14		
IA-19CN-22-12	30 X 2.0	3/4 - 14		
IA-19CN-28-16	36 X 2.0	1 - 11 1/2		
IA-19CN-35-20	45 X 2.0	1 1/4 - 11 1/2		
IA-19CN-42-24	52 X 2.0	1 1/2 - 11 1/2		
IA-19DN-06-04	S	14 X 1.5		1/4 - 18
IA-19DN-08-04		16 X 1.5		1/4 - 18
IA-19DN-10-06		18 X 1.5	3/8 - 18	
IA-19DN-12-06		20 X 1.5	3/8 - 18	
IA-19DN-14-08		22 X 1.5	1/2 - 14	
IA-19DN-16-08		24 X 1.5	1/2 - 14	
IA-19DN-20-12		30 X 2.0	3/4 - 14	
IA-19DN-25-16		36 X 2.0	1 - 11 1/2	
IA-19DN-30-20		42 X 2.0	1 1/4 - 11 1/2	
IA-19DN-38-24		52 X 2.0	1 1/2 - 11 1/2	

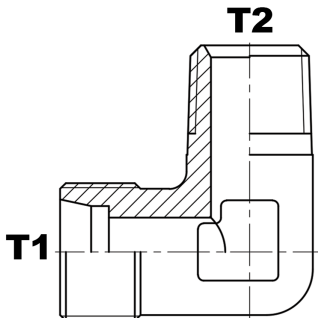

*Note: All Male DIN types include metric tube nut and metric bite sleeve.

*Note: All Female DIN Swivels are DKO Type.

IA-20NC, 20ND

NPT MALE X DIN L & S

PART NUMBER		T1	T2
		IA-20NC-02-06	L
IA-20NC-04-08	1/4 - 18	14 X 1.5	
IA-20NC-06-10	3/8 - 18	16 X 1.5	
IA-20NC-06-12	3/8 - 18	18 X 1.5	
IA-20NC-08-15	1/2 - 14	22 X 1.5	
IA-20NC-08-18	1/2 - 14	26 X 1.5	
IA-20NC-12-22	3/4 - 14	30 X 2.0	
IA-20NC-16-28	1 - 11 1/2	36 X 2.0	
IA-20NC-20-35	1 1/4 - 11 1/2	45 X 2.0	
IA-20NC-24-42	1 1/2 - 11 1/2	52 X 2.0	
IA-20ND-04-06	S	1/4 - 18	14 X 1.5
IA-20ND-04-08		1/4 - 18	16 X 1.5
IA-20ND-06-10		3/8 - 18	18 X 1.5
IA-20ND-06-12		3/8 - 18	20 X 1.5
IA-20ND-08-14		1/2 - 14	22 X 1.5
IA-20ND-08-16		1/2 - 14	24 X 1.5
IA-20ND-12-20		3/4 - 14	30 X 2.0
IA-20ND-16-25		1 - 11 1/2	36 X 2.0
IA-20ND-20-30		1 1/4 - 11 1/2	42 X 2.0
IA-20ND-20-38		1 1/4 - 11 1/2	52 X 2.0

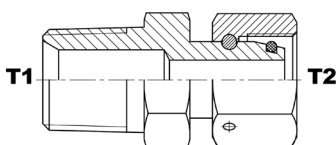

*Note: All Male DIN types include metric tube nut and metric bite sleeve.

*Note: All Female DIN Swivels are DKO Type.

WARNING This product can expose you to chemicals, which are known to the State of California to cause cancer or birth defects or other reproductive harm. For more information visit <https://www.p65warnings.ca.gov/>



IA-10CO, 10DO DIN L & S x M-ORB

	PART NUMBER		T1	T2	
	IA-10CO-08-04	L	14 X 1.5	7/16 - 20	
	IA-10CO-10-04		16 X 1.5	7/16 - 20	
	IA-10CO-10-06		16 X 1.5	9/16 - 18	
	IA-10CO-12-06		18 X 1.5	9/16 - 18	
	IA-10CO-12-08		18 X 1.5	3/4 - 16	
	IA-10CO-12-10		18 X 1.5	7/8 - 14	
	IA-10CO-15-08		22 X 1.5	3/4 - 16	
	IA-10CO-15-10		22 X 1.5	7/8 - 14	
	IA-10CO-18-08		26 X 1.5	3/4 - 16	
	IA-10CO-18-10		26 X 1.5	7/8 - 14	
	IA-10CO-22-08		30 X 2.0	3/4 - 16	
	IA-10CO-22-10		30 X 2.0	7/8 - 14	
	IA-10CO-22-12		30 X 2.0	1 1/16 - 12	
	IA-10CO-28-16		36 X 2.0	1 5/16 - 12	
	IA-10CO-35-20		45 X 2.0	1 5/8 - 12	
	IA-10CO-42-20		52 X 2.0	1 5/8 - 12	
	IA-10DO-06-06		S	14 X 1.5	9/16 - 18
	IA-10DO-08-04			16 X 1.5	7/16 - 20
	IA-10DO-08-06			16 X 1.5	9/16 - 18
	IA-10DO-10-06			18 X 1.5	9/16 - 18
IA-10DO-12-06	20 X 1.5	9/16 - 18			
IA-10DO-12-08	20 X 1.5	3/4 - 16			
IA-10DO-16-08	24 X 1.5	3/4 - 16			
IA-10DO-16-10	24 X 1.5	7/8 - 14			
IA-10DO-20-08	30 X 2.0	3/4 - 16			
IA-10DO-20-10	30 X 2.0	7/8 - 14			
IA-10DO-20-12	30 X 2.0	1 1/16 - 12			
IA-10DO-25-12	36 X 2.0	1 1/16 - 12			
IA-10DO-25-16	36 X 2.0	1 5/16 - 12			
IA-10DO-30-16	42 X 2.0	1 5/16 - 12			
IA-10DO-30-20	42 X 2.0	1 5/8 - 12			
IA-10DO-38-20	52 X 2.0	1 5/8 - 12			

*Note: All Male DIN types include metric tube nut and metric bite sleeve.

*Note: All Female DIN Swivels are DKO Type.

IA-19CO, 19DO DIN L & S x 90° M-ORB ADJ.

	PART NUMBER		T1	T2	
	IA-19CO-06-04	L	12 X 1.5	7/16 - 20	
	IA-19CO-08-04		14 X 1.5	7/16 - 20	
	IA-19CO-10-04		16 X 1.5	7/16 - 20	
	IA-19CO-10-06		16 X 1.5	9/16 - 18	
	IA-19CO-12-06		18 X 1.5	9/16 - 18	
	IA-19CO-15-08		22 X 1.5	3/4 - 16	
	IA-19CO-18-12		26 X 1.5	1 1/16 - 12	
	IA-19CO-22-12		30 X 2.0	1 1/16 - 12	
	IA-19DO-06-04		S	14 X 1.5	7/16 - 20
	IA-19DO-08-06			16 X 1.5	9/16 - 18
	IA-19DO-10-06	18 X 1.5		9/16 - 18	
	IA-19DO-12-06	20 X 1.5		9/16 - 18	
	IA-19DO-12-08	20 X 1.5		3/4 - 16	
	IA-19DO-14-10	22 X 1.5		7/8 - 14	
	IA-19DO-16-08	24 X 1.5		3/4 - 16	
	IA-19DO-16-10	24 X 1.5		7/8 - 14	
	IA-19DO-20-12	30 X 2.0		1 1/16 - 12	
	IA-19DO-25-16	36 X 2.0		1 5/16 - 12	

*Note: All Male DIN types include metric tube nut and metric bite sleeve.

*Note: All Female DIN Swivels are DKO Type.



WARNING This product can expose you to chemicals, which are known to the State of California to cause cancer or birth defects or other reproductive harm. For more information visit <https://www.p65warnings.ca.gov/>

IA-ACCO, ADDO

DIN L & S x M-ORB ADJ. BR. TEE

PART NUMBER		T1	T2	T3
		IA-ACCO-06-06-04	L	12 X 1.5
IA-ACCO-08-08-06	14 X 1.5	14 X 1.5		9/16 - 18
IA-ACCO-10-10-06	16 X 1.5	16 X 1.5		9/16 - 18
IA-ACCO-12-12-08	18 X 1.5	18 X 1.5		3/4 - 16
IA-ACCO-15-15-10	22 X 1.5	22 X 1.5		7/8 - 14
IA-ACCO-18-18-12	26 X 1.5	26 X 1.5		1 1/16 - 12
IA-ACCO-22-22-12	30 X 2.0	30 X 2.0		1 1/16 - 12
IA-ACCO-28-28-16	36 X 2.0	36 X 2.0		1 5/16 - 12
IA-ACCO-35-35-20	45 X 2.0	45 X 2.0		1 5/8 - 12
IA-ADDO-06-06-04	S	14 X 1.5		14 X 1.5
IA-ADDO-08-08-06		16 X 1.5	16 X 1.5	9/16 - 18
IA-ADDO-10-10-06		18 X 1.5	18 X 1.5	9/16 - 18
IA-ADDO-12-12-08		20 X 1.5	20 X 1.5	3/4 - 16
IA-ADDO-14-14-10		22 X 1.5	22 X 1.5	7/8 - 14
IA-ADDO-16-16-10		24 X 1.5	24 X 1.5	7/8 - 14
IA-ADDO-20-20-12		30 X 2.0	30 X 2.0	1 1/16 - 12
IA-ADDO-25-25-16		36 X 2.0	36 X 2.0	1 5/16 - 12
IA-ADDO-30-30-20		42 X 2.0	42 X 2.0	1 5/8 - 12

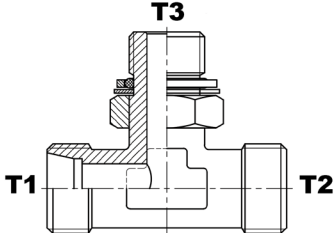

*Note: All Male DIN types include metric tube nut and metric bite sleeve.
 *Note: All Female DIN Swivels are DKO Type.

IA-ACOC, ADOD

DIN L & S x M-ORB ADJ. RUN TEE

PART NUMBER		T1	T2	T3
IA-ACOC-06-06-04	L	12 X 1.5	7/16 - 20	12 X 1.5
IA-ACOC-08-08-06		14 X 1.5	9/16 - 18	14 X 1.5
IA-ACOC-10-10-06		16 X 1.5	9/16 - 18	16 X 1.5
IA-ACOC-12-12-08		18 X 1.5	3/4 - 16	18 X 1.5
IA-ACOC-15-15-10		22 X 1.5	7/8 - 14	22 X 1.5
IA-ACOC-18-18-12		26 X 1.5	1 1/16 - 12	26 X 1.5
IA-ACOC-22-22-12		30 X 2.0	1 1/16 - 12	30 X 2.0
IA-ACOC-28-28-16		36 X 2.0	1 5/16 - 12	36 X 2.0
IA-ACOC-35-35-20		45 X 2.0	1 5/8 - 12	45 X 2.0
IA-ADOD-06-06-04		S	14 X 1.5	7/16 - 20
IA-ADOD-08-08-06	16 X 1.5		9/16 - 18	16 X 1.5
IA-ADOD-10-10-06	18 X 1.5		9/16 - 18	18 X 1.5
IA-ADOD-12-12-08	20 X 1.5		3/4 - 16	20 X 1.5
IA-ADOD-14-14-10	22 X 1.5		7/8 - 14	22 X 1.5
IA-ADOD-16-16-10	24 X 1.5		7/8 - 14	24 X 1.5
IA-ADOD-20-20-12	30 X 2.0		1 1/16 - 12	30 X 2.0
IA-ADOD-25-25-16	36 X 2.0		1 5/16 - 12	36 X 2.0
IA-ADOD-30-30-20	42 X 2.0		1 5/8 - 12	42 X 2.0

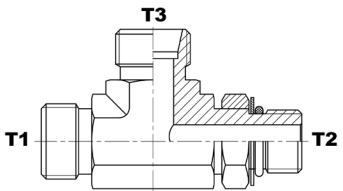

*Note: All Male DIN types include metric tube nut and metric bite sleeve.
 *Note: All Female DIN Swivels are DKO Type.

DIN BITE-TYPE 12° SEAT



WARNING This product can expose you to chemicals, which are known to the State of California to cause cancer or birth defects or other reproductive harm. For more information visit <https://www.p65warnings.ca.gov/>



IA-10JA, 10JC, 10JD JIC MALE x DIN LL, L & S MALE

	PART NUMBER		T1	T2
		IA-10JA-04-06	LL	7/16 - 20
IA-10JA-04-08		7/16 - 20		12 X 1.0
IA-10JC-04-06		L	7/16 - 20	12 X 1.5
IA-10JC-04-08			7/16 - 20	14 X 1.5
IA-10JC-06-08			9/16 - 18	14 X 1.5
IA-10JC-06-10			9/16 - 18	16 X 1.5
IA-10JC-06-12			9/16 - 18	18 X 1.5
IA-10JC-08-12			3/4 - 16	18 X 1.5
IA-10JC-08-15			3/4 - 16	22 X 1.5
IA-10JC-10-15			7/8 - 14	22 X 1.5
IA-10JC-10-18			7/8 - 14	26 X 1.5
IA-10JC-12-18			1 1/16 - 12	26 X 1.5
IA-10JC-12-22			1 1/16 - 12	30 X 2.0
IA-10JC-16-28			1 5/16 - 12	36 X 2.0
IA-10JC-20-35			1 5/8 - 12	45 X 2.0
IA-10JC-24-42			1 7/8 - 12	52 X 2.0
IA-10JD-04-06		S	7/16 - 20	14 X 1.5
IA-10JD-04-08			7/16 - 20	16 X 1.5
IA-10JD-04-10			7/16 - 20	18 X 1.5
IA-10JD-06-06			9/16 - 18	14 X 1.5
IA-10JD-06-08			9/16 - 18	16 X 1.5
IA-10JD-06-10			9/16 - 18	18 X 1.5
IA-10JD-06-12			9/16 - 18	20 X 1.5
IA-10JD-06-14			9/16 - 18	22 X 1.5
IA-10JD-08-12			3/4 - 16	20 X 1.5
IA-10JD-08-14			3/4 - 16	22 X 1.5
IA-10JD-08-16			3/4 - 16	24 X 1.5
IA-10JD-10-12			7/8 - 14	20 X 1.5
IA-10JD-10-16			7/8 - 14	24 X 1.5
IA-10JD-10-20			7/8 - 14	30 X 2.0
IA-10JD-12-20	1 1/16 - 12		30 X 2.0	
IA-10JD-12-25	1 1/16 - 12		36 X 2.0	
IA-10JD-16-25	1 5/16 - 12		36 X 2.0	
IA-10JD-20-30	1 5/8 - 12		42 X 2.0	
IA-10JD-20-38	1 5/8 - 12		52 X 2.0	
IA-10JD-24-38	1 7/8 - 12		52 X 2.0	

*Note: All Male DIN types include metric tube nut and metric bite sleeve.

*Note: All Female DIN Swivels are DKO Type.



WARNING This product can expose you to chemicals, which are known to the State of California to cause cancer or birth defects or other reproductive harm. For more information visit <https://www.p65warnings.ca.gov/>

IA-20JA, 20JC, 20JD JIC MALE x DIN LL, L & S FEMALE SWIVEL

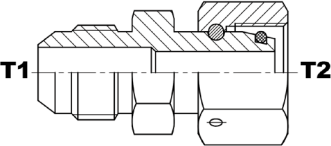
	PART NUMBER		T1	T2	
		LL	IA-20JA-04-06	7/16 - 20	10 X 1.0
			IA-20JA-04-08	7/16 - 20	12 X 1.0
L		IA-20JC-04-06	7/16 - 20	12 X 1.5	
		IA-20JC-04-08	7/16 - 20	14 X 1.5	
		IA-20JC-05-08	1/2 - 20	14 X 1.5	
		IA-20JC-05-10	1/2 - 20	16 X 1.5	
		IA-20JC-06-08	9/16 - 18	14 X 1.5	
		IA-20JC-06-10	9/16 - 18	16 X 1.5	
		IA-20JC-06-12	9/16 - 18	18 X 1.5	
		IA-20JC-08-10	3/4 - 16	16 X 1.5	
		IA-20JC-08-12	3/4 - 16	18 X 1.5	
		IA-20JC-08-15	3/4 - 16	22 X 1.5	
		IA-20JC-10-15	7/8 - 14	22 X 1.5	
		IA-20JC-10-18	7/8 - 14	26 X 1.5	
		IA-20JC-12-18	1 1/16 - 12	26 X 1.5	
		IA-20JC-12-22	1 1/16 - 12	30 X 2.0	
		IA-20JC-16-28	1 5/16 - 12	36 X 2.0	
		IA-20JC-20-35	1 5/8 - 12	45 X 2.0	
		IA-20JC-20-42	1 5/8 - 12	52 X 2.0	
		IA-20JC-24-42	1 7/8 - 12	52 X 2.0	
S	IA-20JD-04-06	7/16 - 20	14 X 1.5		
	IA-20JD-04-08	7/16 - 20	16 X 1.5		
	IA-20JD-04-10	7/16 - 20	18 X 1.5		
	IA-20JD-05-10	1/2 - 20	18 X 1.5		
	IA-20JD-05-12	1/2 - 20	20 X 1.5		
	IA-20JD-06-08	9/16 - 18	16 X 1.5		
	IA-20JD-06-10	9/16 - 18	18 X 1.5		
	IA-20JD-06-12	9/16 - 18	20 X 1.5		
	IA-20JD-06-14	9/16 - 18	22 X 1.5		
	IA-20JD-08-12	3/4 - 16	20 X 1.5		
	IA-20JD-08-14	3/4 - 16	22 X 1.5		
	IA-20JD-08-16	3/4 - 16	24 X 1.5		
	IA-20JD-10-12	7/8 - 14	20 X 1.5		
	IA-20JD-10-16	7/8 - 14	24 X 1.5		
	IA-20JD-10-20	7/8 - 14	30 X 2.0		
	IA-20JD-12-16	1 1/16 - 12	24 X 1.5		
	IA-20JD-12-20	1 1/16 - 12	30 X 2.0		
	IA-20JD-12-25	1 1/16 - 12	36 X 2.0		
	IA-20JD-16-20	1 5/16 - 12	30 X 2.0		
	IA-20JD-16-25	1 5/16 - 12	36 X 2.0		
IA-20JD-16-30	1 5/16 - 12	42 X 2.0			
IA-20JD-20-30	1 5/8 - 12	42 X 2.0			
IA-20JD-20-38	1 5/8 - 12	52 X 2.0			
IA-20JD-24-38	1 7/8 - 12	52 X 2.0			

*Note: All Male DIN types include metric tube nut and metric bite sleeve.

*Note: All Female DIN Swivels are DKO Type.

 **WARNING** This product can expose you to chemicals, which are known to the State of California to cause cancer or birth defects or other reproductive harm. For more information visit <https://www.p65warnings.ca.gov/>



IA-29JC, 29JD

90° JIC MALE x DIN L & S FEMALE SWIVEL

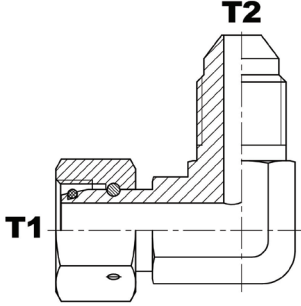
	PART NUMBER		T1	T2
	L	IA-29JC-04-06		7/16 - 20
IA-29JC-06-08			9/16 - 18	14 X 1.5
IA-29JC-06-10			9/16 - 18	16 X 1.5
IA-29JC-08-12			3/4 - 16	18 X 1.5
IA-29JC-10-15			7/8 - 14	22 X 1.5
IA-29JC-12-18			1 1/16 - 12	26 X 1.5
IA-29JC-16-22			1 5/16 - 12	30 X 2.0
IA-29JC-16-28			1 5/16 - 12	36 X 2.0
S	IA-29JD-04-06		7/16 - 20	14 X 1.5
	IA-29JD-06-08		9/16 - 18	16 X 1.5
	IA-29JD-06-10		9/16 - 18	18 X 1.5
	IA-29JD-08-12		3/4 - 16	20 X 1.5
	IA-29JD-10-16		7/8 - 14	24 X 1.5
	IA-29JD-12-20		1 1/16 - 12	30 X 2.0

*Note: All Male DIN types include metric tube nut and metric bite sleeve.

*Note: All Female DIN Swivels are DKO Type.

IA-10JV

JIC MALE x METRIC STAND PIPE

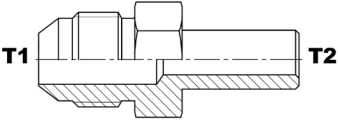
	PART NUMBER	T1	T2
	IA-10JV-04-04		7/16 - 20
IA-10JV-04-06		7/16 - 20	6
IA-10JV-04-08		7/16 - 20	8
IA-10JV-04-10		7/16 - 20	10
IA-10JV-06-08		9/16 - 18	8
IA-10JV-06-10		9/16 - 18	10
IA-10JV-06-12		9/16 - 18	12
IA-10JV-06-14		9/16 - 18	14
IA-10JV-08-10		3/4 - 16	10
IA-10JV-08-12		3/4 - 16	12
IA-10JV-08-14		3/4 - 16	14
IA-10JV-08-15		3/4 - 16	15
IA-10JV-08-16		3/4 - 16	16
IA-10JV-10-16		7/8 - 14	16
IA-10JV-10-18		7/8 - 14	18
IA-10JV-12-16		1 1/16 - 12	16
IA-10JV-12-18		1 1/16 - 12	18
IA-10JV-12-20		1 1/16 - 12	20
IA-10JV-12-22		1 1/16 - 12	22
IA-10JV-12-25		1 1/16 - 12	25
IA-10JV-16-22		1 5/16 - 12	22
IA-10JV-16-25		1 5/16 - 12	25
IA-10JV-16-30		1 5/16 - 12	30
IA-10JV-20-28		1 5/8 - 12	28
IA-10JV-24-38		1 7/8 - 12	38

*Note: All Male DIN types include metric tube nut and metric bite sleeve.

*Note: All Female DIN Swivels are DKO Type.



WARNING This product can expose you to chemicals, which are known to the State of California to cause cancer or birth defects or other reproductive harm. For more information visit <https://www.p65warnings.ca.gov/>

IA-0CM

METRIC 60° CONE SEAT FEMALE CAP

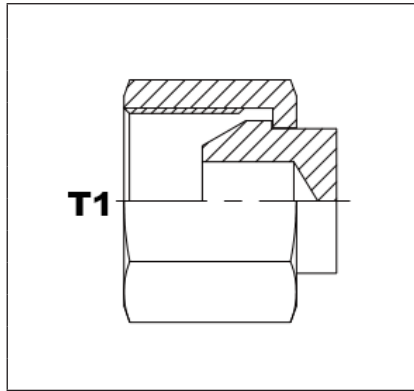

PART NUMBER	T1
IA-0CM-12	12 X 1.5
IA-0CM-14	14 X 1.5
IA-0CM-16	16 X 1.5
IA-0CM-18	18 X 1.5
IA-0CM-20	20 X 1.5
IA-0CM-22	22 X 1.5

IA-0PM

METRIC 60° CONE SEAT MALE PLUG

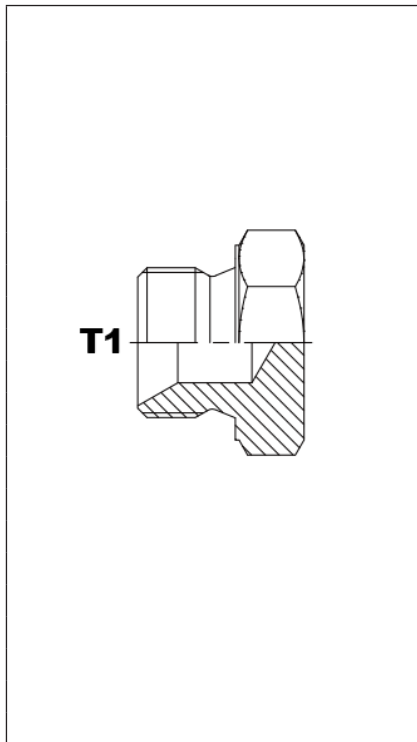

PART NUMBER	T1
IA-0PM-08	8 X 1.0
IA-0PM-10	10 X 1.0
IA-0PM-12	12 X 1.5
IA-0PM-12A	12 X 1.0
IA-0PM-14	14 X 1.5
IA-0PM-16	16 X 1.5
IA-0PM-18	18 X 1.5
IA-0PM-20	20 X 1.5
IA-0PM-22	22 X 1.5
IA-0PM-24	24 X 1.5
IA-0PM-26	26 X 1.5
IA-0PM-27D	27 X 1.5
IA-0PM-30	30 X 2.0
IA-0PM-30D	30 X 1.5
IA-0PM-33	33 X 2.0
IA-0PM-36D	36 X 1.5
IA-0PM-38	38 X 2.0
IA-0PM-38D	38 X 1.5
IA-0PM-45	45 X 2.0
IA-0PM-45D	45 X 1.5
IA-0PM-52	52 X 2.0
IA-0PM-52D	52 X 1.5

METRIC (60° SEAT & RIGID FEMALE)



WARNING This product can expose you to chemicals, which are known to the State of California to cause cancer or birth defects or other reproductive harm. For more information visit <https://www.p65warnings.ca.gov/>

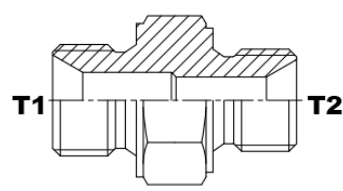

IA-10MM METRIC MALE UNION

	PART NUMBER	T1	T2
	IA-10MM-10-10	10 X 1.0	10 X 1.0
IA-10MM-12-10	12 X 1.5	10 X 1.0	
IA-10MM-12-12	12 X 1.5	12 X 1.5	
IA-10MM-14-12	14 X 1.5	12 X 1.5	
IA-10MM-14-14	14 X 1.5	14 X 1.5	
IA-10MM-16-12	16 X 1.5	12 X 1.5	
IA-10MM-16-14	16 X 1.5	14 X 1.5	
IA-10MM-16-16	16 X 1.5	16 X 1.5	
IA-10MM-18-16	18 X 1.5	16 X 1.5	
IA-10MM-18-18	18 X 1.5	18 X 1.5	
IA-10MM-20-18	20 X 1.5	18 X 1.5	
IA-10MM-22-18	22 X 1.5	18 X 1.5	
IA-10MM-22-22	22 X 1.5	22 X 1.5	
IA-10MM-26-16	26 X 1.5	16 X 1.5	
IA-10MM-26-18	26 X 1.5	18 X 1.5	
IA-10MM-26-22	26 X 1.5	22 X 1.5	
IA-10MM-26-26	26 X 1.5	26 X 1.5	

IA-60MM METRIC MALE BULKHEAD UNION W/ LOCKNUT

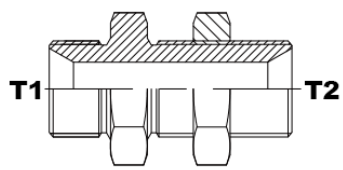
	PART NUMBER	T1	T2
	IA-60MM-12-12-LN	12 X 1.5	12 X 1.5
IA-60MM-14-14-LN	14 X 1.5	14 X 1.5	
IA-60MM-16-16-LN	16 X 1.5	16 X 1.5	
IA-60MM-18-18-LN	18 X 1.5	18 X 1.5	
IA-60MM-20-20-LN	20 X 1.5	20 X 1.5	
IA-60MM-22-22-LN	22 X 1.5	22 X 1.5	
IA-60MM-24-24-LN	24 X 1.5	24 X 1.5	

IA-20MM METRIC MALE x FEMALE SWIVEL

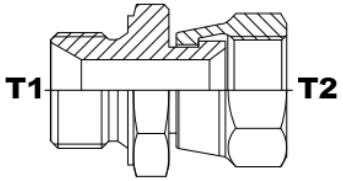
	PART NUMBER	T1	T2
	IA-20MM-12-12	12 X 1.5	12 X 1.5
IA-20MM-14-14	14 X 1.5	14 X 1.5	
IA-20MM-16-16	16 X 1.5	16 X 1.5	
IA-20MM-16-18	16 X 1.5	18 X 1.5	
IA-20MM-18-16	18 X 1.5	16 X 1.5	
IA-20MM-18-18	18 X 1.5	18 X 1.5	
IA-20MM-18-20	18 X 1.5	20 X 1.5	
IA-20MM-18-22	18 X 1.5	22 X 1.5	
IA-20MM-20-18	20 X 1.5	18 X 1.5	
IA-20MM-20-20	20 X 1.5	20 X 1.5	
IA-20MM-20-22	20 X 1.5	22 X 1.5	
IA-20MM-22-18	22 X 1.5	18 X 1.5	
IA-20MM-22-20	22 X 1.5	20 X 1.5	
IA-20MM-22-22	22 X 1.5	22 X 1.5	
IA-20MM-27-27	27 X 2.0	27 X 2.0	
IA-20MM-27D-27D	27 X 1.5	27 X 1.5	
IA-20MM-30-30	30 X 2.0	30 X 2.0	
IA-20MM-30D-30D	30 X 1.5	30 X 1.5	

⚠ WARNING This product can expose you to chemicals, which are known to the State of California to cause cancer or birth defects or other reproductive harm. For more information visit <https://www.p65warnings.ca.gov/>

IA-30MM METRIC FEMALE SWIVEL UNION

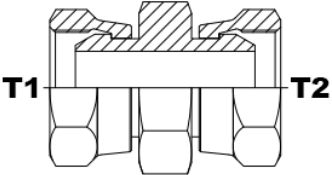
	PART NUMBER	T1	T2
	IA-30MM-12-12	12 X 1.5	12 X 1.5
	IA-30MM-14-14	14 X 1.5	14 X 1.5
	IA-30MM-16-16	16 X 1.5	16 X 1.5
	IA-30MM-18-18	18 X 1.5	18 X 1.5
	IA-30MM-20-18	20 X 1.5	18 X 1.5
	IA-30MM-20-20	20 X 1.5	20 X 1.5
	IA-30MM-22-18	22 X 1.5	18 X 1.5
	IA-30MM-22-20	22 X 1.5	20 X 1.5
	IA-30MM-22-22	22 X 1.5	22 X 1.5

IA-50MM METRIC MALE x FEMALE RIGID

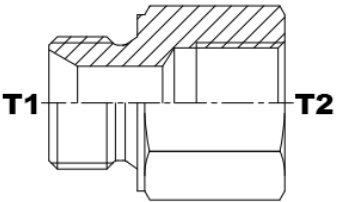
	PART NUMBER	T1	T2
	IA-50MM-14-14	14 X 1.5	14 X 1.5
	IA-50MM-14-16	14 X 1.5	16 X 1.5
	IA-50MM-16-12	16 X 1.5	12 X 1.5
	IA-50MM-16-18	16 X 1.5	18 X 1.5
	IA-50MM-16-20	16 X 1.5	20 X 1.5
	IA-50MM-16-22	16 X 1.5	22 X 1.5
	IA-50MM-18-14	18 X 1.5	14 X 1.5
	IA-50MM-22-16	22 X 1.5	16 X 1.5
	IA-50MM-24-18	24 X 1.5	18 X 1.5

IA-70MM METRIC FEMALE COUPLING RIGID

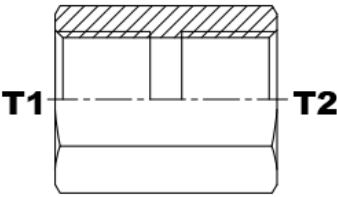
	PART NUMBER	T1	T2
	IA-70MM-12-12	12 X 1.5	12 X 1.5
	IA-70MM-14-14	14 X 1.5	14 X 1.5
	IA-70MM-16-12	16 X 1.5	12 X 1.5
	IA-70MM-16-16	16 X 1.5	16 X 1.5
	IA-70MM-18-18	18 X 1.5	18 X 1.5
	IA-70MM-20-20	20 X 1.5	20 X 1.5
	IA-70MM-22-16	22 X 1.5	16 X 1.5
	IA-70MM-22-22	22 X 1.5	22 X 1.5

WARNING This product can expose you to chemicals, which are known to the State of California to cause cancer or birth defects or other reproductive harm. For more information visit <https://www.p65warnings.ca.gov/>



IA-10JM JIC MALE x METRIC MALE

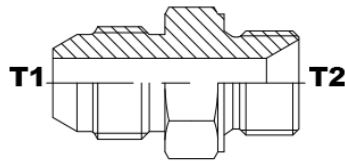

PART NUMBER	T1	T2
IA-10JM-04-10	7/16 - 20	10 X 1.0
IA-10JM-04-12	7/16 - 20	12 X 1.5
IA-10JM-04-14	7/16 - 20	14 X 1.5
IA-10JM-05-10	1/2 - 20	10 X 1.0
IA-10JM-05-12	1/2 - 20	12 X 1.5
IA-10JM-05-14	1/2 - 20	14 X 1.5
IA-10JM-06-10	9/16 - 18	10 X 1.0
IA-10JM-06-12	9/16 - 18	12 X 1.5
IA-10JM-06-12B	9/16 - 18	12 X 1.25
IA-10JM-06-14	9/16 - 18	14 X 1.5
IA-10JM-06-16	9/16 - 18	16 X 1.5
IA-10JM-06-18	9/16 - 18	18 X 1.5
IA-10JM-06-20	9/16 - 18	20 X 1.5
IA-10JM-06-22	9/16 - 18	22 X 1.5
IA-10JM-08-12	3/4 - 16	12 X 1.5
IA-10JM-08-14	3/4 - 16	14 X 1.5
IA-10JM-08-16	3/4 - 16	16 X 1.5
IA-10JM-08-18	3/4 - 16	18 X 1.5
IA-10JM-08-20	3/4 - 16	20 X 1.5
IA-10JM-08-22	3/4 - 16	22 X 1.5
IA-10JM-10-16	7/8 - 14	16 X 1.5
IA-10JM-10-18	7/8 - 14	18 X 1.5
IA-10JM-10-20	7/8 - 14	20 X 1.5
IA-10JM-10-22	7/8 - 14	22 X 1.5
IA-10JM-10-24	7/8 - 14	24 X 1.5
IA-10JM-10-26	7/8 - 14	26 X 1.5
IA-10JM-12-18	1 1/16 - 12	18 X 1.5
IA-10JM-12-20	1 1/16 - 12	20 X 1.5
IA-10JM-12-22	1 1/16 - 12	22 X 1.5
IA-10JM-12-24	1 1/16 - 12	24 X 1.5
IA-10JM-12-26	1 1/16 - 12	26 X 1.5
IA-10JM-12-27	1 1/16 - 12	27 X 2.0
IA-10JM-12-30	1 1/16 - 12	30 X 2.0
IA-10JM-12-30D	1 1/16 - 12	30 X 1.5
IA-10JM-12-33	1 1/16 - 12	33 X 2.0
IA-10JM-16-20	1 5/16 - 12	20 X 1.5
IA-10JM-16-22	1 5/16 - 12	22 X 1.5
IA-10JM-16-26	1 5/16 - 12	26 X 1.5
IA-10JM-16-27	1 5/16 - 12	27 X 2.0
IA-10JM-16-30	1 5/16 - 12	30 X 2.0
IA-10JM-16-30D	1 5/16 - 12	30 X 1.5
IA-10JM-16-33	1 5/16 - 12	33 X 2.0
IA-10JM-20-38	1 5/8 - 12	38 X 2.0
IA-10JM-20-45	1 5/8 - 12	45 X 2.0
IA-10JM-24-45	1 7/8 - 12	45 X 2.0
IA-10JM-24-52	1 7/8 - 12	52 X 2.0

WARNING This product can expose you to chemicals, which are known to the State of California to cause cancer or birth defects or other reproductive harm. For more information visit <https://www.p65warnings.ca.gov/>

IA-10JM-BS

JIC MALE x METRIC MALE W/ BONDED SEAL

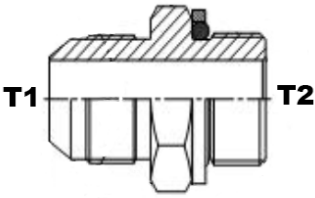
	PART NUMBER	T1	T2
	IA-10JM-04-10-BS	7/16 - 20	10 X 1.0
IA-10JM-04-12-BS	7/16 - 20	12 X 1.5	
IA-10JM-04-14-BS	7/16 - 20	14 X 1.5	
IA-10JM-06-12-BS	9/16 - 18	12 X 1.5	
IA-10JM-06-14-BS	9/16 - 18	14 X 1.5	
IA-10JM-06-16-BS	9/16 - 18	16 X 1.5	
IA-10JM-06-18-BS	9/16 - 18	18 X 1.5	
IA-10JM-08-12-BS	3/4 - 16	12 X 1.5	
IA-10JM-08-16-BS	3/4 - 16	16 X 1.5	
IA-10JM-08-18-BS	3/4 - 16	18 X 1.5	
IA-10JM-08-22-BS	3/4 - 16	22 X 1.5	
IA-10JM-12-22-BS	1 1/16 - 12	22 X 1.5	
IA-10JM-12-27-BS	1 1/16 - 12	27 X 2.0	

IA-10JM-WD

JIC MALE x METRIC MALE + CAPTIVE SEAL

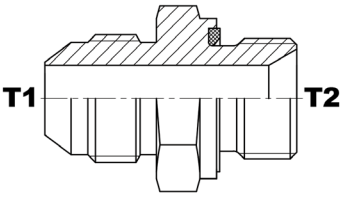
	PART NUMBER	T1	T2
	IA-10JM-04-10-WD	7/16 - 20	10 X 1.0
IA-10JM-04-12-WD	7/16 - 20	12 X 1.5	
IA-10JM-06-14-WD	9/16 - 18	14 X 1.5	
IA-10JM-06-16-WD	9/16 - 18	16 X 1.5	
IA-10JM-06-18-WD	9/16 - 18	18 X 1.5	
IA-10JM-08-14-WD	3/4 - 16	14 X 1.5	
IA-10JM-08-16-WD	3/4 - 16	16 X 1.5	
IA-10JM-08-18-WD	3/4 - 16	18 X 1.5	
IA-10JM-08-20-WD	3/4 - 16	20 X 1.5	
IA-10JM-08-22-WD	3/4 - 16	22 X 1.5	
IA-10JM-10-20-WD	7/8 - 14	20 X 1.5	
IA-10JM-10-22-WD	7/8 - 14	22 X 1.5	
IA-10JM-12-22-WD	1 1/16 - 12	22 X 1.5	
IA-10JM-12-26-WD	1 1/16 - 12	26 X 1.5	
IA-10JM-12-27-WD	1 1/16 - 12	27 X 2.0	
IA-10JM-16-33-WD	1 5/16 - 12	33 X 2.0	
IA-10JM-20-42-WD	1 5/8 - 12	42 X 2.0	
IA-10JM-20-48-WD	1 5/8 - 12	48 X 2.0	
IA-10JM-24-48-WD	1 7/8 - 12	48 X 2.0	

IA-20MJ

METRIC MALE x FEMALE JIC SWIVEL

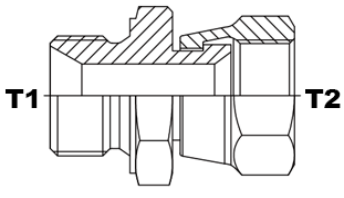
	PART NUMBER	T1	T2
	IA-20MJ-10-04	10 X 1.0	7/16 - 20
IA-20MJ-12-05	12 X 1.5	1/2 - 20	
IA-20MJ-14-06	14 X 1.5	9/16 - 18	
IA-20MJ-16-08	16 X 1.5	3/4 - 16	
IA-20MJ-18-06	18 X 1.5	9/16 - 18	
IA-20MJ-18-08	18 X 1.5	3/4 - 16	
IA-20MJ-18-10	18 X 1.5	7/8 - 14	
IA-20MJ-20-10	20 X 1.5	7/8 - 14	
IA-20MJ-22-08	22 X 1.5	3/4 - 16	
IA-20MJ-22-10	22 X 1.5	7/8 - 14	

WARNING This product can expose you to chemicals, which are known to the State of California to cause cancer or birth defects or other reproductive harm. For more information visit <https://www.p65warnings.ca.gov/>





IA-20JM

JIC MALE x METRIC FEMALE SWIVEL

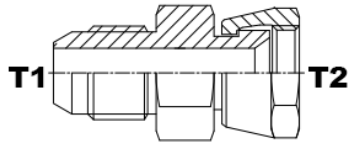

PART NUMBER	T1	T2
IA-20JM-05-12	1/2 - 20	12 X 1.5
IA-20JM-06-14	9/16 - 18	14 X 1.5
IA-20JM-06-16	9/16 - 18	16 X 1.5
IA-20JM-06-18	9/16 - 18	18 X 1.5
IA-20JM-06-20	9/16 - 18	20 X 1.5
IA-20JM-06-22	9/16 - 18	22 X 1.5
IA-20JM-08-16	3/4 - 16	16 X 1.5
IA-20JM-08-18	3/4 - 16	18 X 1.5
IA-20JM-08-20	3/4 - 16	20 X 1.5
IA-20JM-08-22	3/4 - 16	22 X 1.5
IA-20JM-10-16	7/8 - 14	16 X 1.5
IA-20JM-10-18	7/8 - 14	18 X 1.5
IA-20JM-10-20	7/8 - 14	20 X 1.5
IA-20JM-10-22	7/8 - 14	22 X 1.5

IA-10FM

ORFS MALE x METRIC 60° MALE

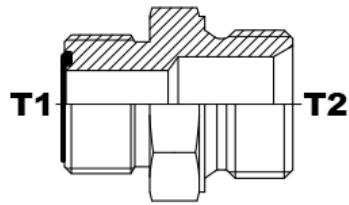

PART NUMBER	T1	T2
IA-10FM-04-10	9/16 - 18	10 X 1.0
IA-10FM-04-12	9/16 - 18	12 X 1.5
IA-10FM-04-14	9/16 - 18	14 X 1.5
IA-10FM-06-12	11/16 - 16	12 X 1.5
IA-10FM-06-14	11/16 - 16	14 X 1.5
IA-10FM-06-16	11/16 - 16	16 X 1.5
IA-10FM-06-18	11/16 - 16	18 X 1.5
IA-10FM-08-16	13/16 - 16	16 X 1.5
IA-10FM-08-18	13/16 - 16	18 X 1.5
IA-10FM-08-22	13/16 - 16	22 X 1.5
IA-10FM-10-20	1 - 14	20 X 1.5
IA-10FM-10-22	1 - 14	22 X 1.5
IA-10FM-12-18	1 3/16 - 12	18 X 1.5
IA-10FM-12-22	1 3/16 - 12	22 X 1.5
IA-10FM-16-27	1 7/16 - 12	27 X 2.0
IA-10FM-16-33	1 7/16 - 12	33 X 2.0
IA-10FM-20-42	1 11/16 - 12	42 X 2.0
IA-10FM-24-48	2 - 12	48 X 2.0

WARNING This product can expose you to chemicals, which are known to the State of California to cause cancer or birth defects or other reproductive harm. For more information visit <https://www.p65warnings.ca.gov/>

IA-50MN

METRIC MALE x NPT FEMALE

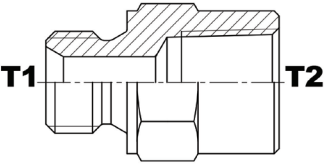
	PART NUMBER	T1	T2
		IA-50MN-06-02	6 X 1.0
	IA-50MN-08-02	8 X 1.0	1/8 - 27
	IA-50MN-10-02	10 X 1.0	1/8 - 27
	IA-50MN-10-04	10 X 1.0	1/4 - 18
	IA-50MN-10A-02	10 X 1.25	1/8 - 27
	IA-50MN-10B-02	10 X 1.5	1/8 - 27
	IA-50MN-12-06	12 X 1.5	3/8 - 18
	IA-50MN-12B-04	12 X 1.25	1/4 - 18
	IA-50MN-16-06	16 X 1.5	3/8 - 18
	IA-50MN-20-04	20 X 1.5	1/4 - 18
	IA-50MN-20-08	20 X 1.5	1/2 - 14
	IA-50MN-22-04	22 X 1.5	1/4 - 18
	IA-50MN-22-06	22 X 1.5	3/8 - 18
	IA-50MN-27D-12	27 X 1.5	3/4 - 14
	IA-50MN-33D-08	33 X 1.5	1/2 - 14

IA-50MO

METRIC MALE x ORB FEMALE

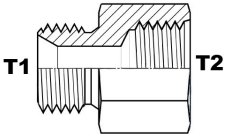
	PART NUMBER	T1	T2
		IA-50MO-14-06	14 X 1.5
	IA-50MO-26-12	26 X 1.5	1 1/16 - 12
	IA-50MO-27-12	27 X 2.0	1 1/16 - 12

IA-50NM

NPT MALE x METRIC FEMALE

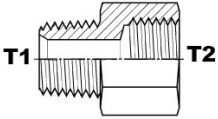
	PART NUMBER	T1	T2
		IA-50NM-02-08	1/8 - 27
	IA-50NM-04-12	1/4 - 18	12 X 1.5
	IA-50NM-04-14	1/4 - 18	14 X 1.5
	IA-50NM-06-14	3/8 - 18	14 X 1.5
	IA-50NM-06-18	3/8 - 18	18 X 1.5
	IA-50NM-08-18	1/2 - 14	18 X 1.5
	IA-50NM-08-20	1/2 - 14	20 X 1.5
	IA-50NM-08-22	1/2 - 14	22 X 1.5

WARNING This product can expose you to chemicals, which are known to the State of California to cause cancer or birth defects or other reproductive harm. For more information visit <https://www.p65warnings.ca.gov/>





IA-70NM

NPT FEMALE x METRIC FEMALE

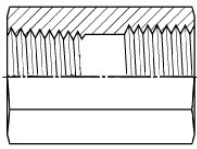
	PART NUMBER	T1	T2
	IA-70NM-04-12	1/4 - 18	12 X 1.5
	IA-70NM-04-14	1/4 - 18	14 X 1.5
	IA-70NM-04-16	1/4 - 18	16 X 1.5

IA-0LNM

METRIC BULKHEAD LOCKNUT

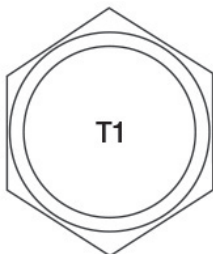
	PART NUMBER	T1
	IA-0LNM-10	10 X 1.0
	IA-0LNM-12	12 X 1.5
	IA-0LNM-14	14 X 1.5
	IA-0LNM-16	16 X 1.5
	IA-0LNM-18	18 X 1.5
	IA-0LNM-20	20 X 1.5
	IA-0LNM-22	22 X 1.5
	IA-0LNM-24	24 X 1.5
	IA-0LNM-26	26 X 1.5
	IA-0LNM-30	30 X 2.0
	IA-0LNM-36	36 X 2.0
	IA-0LNM-42	42 X 2.0
	IA-0LNM-45	45 X 2.0
	IA-0LNM-52	52 X 2.0

WARNING This product can expose you to chemicals, which are known to the State of California to cause cancer or birth defects or other reproductive harm. For more information visit <https://www.p65warnings.ca.gov/>

IA-0PHH-WD

METRIC PORT PLUG (CAPTIVE SEAL)

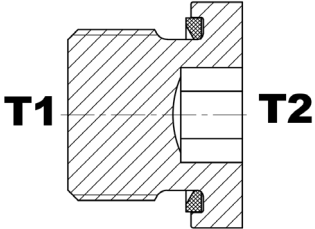
	PART NUMBER	T1
	IA-0PHH-08-WD	8 X 1.0
	IA-0PHH-10-WD	10 X 1.0
	IA-0PHH-12-WD	12 X 1.5
	IA-0PHH-14-WD	14 X 1.5
	IA-0PHH-16-WD	16 X 1.5
	IA-0PHH-18-WD	18 X 1.5
	IA-0PHH-20-WD	20 X 1.5
	IA-0PHH-22-WD	22 X 1.5
	IA-0PHH-24-WD	24 X 1.5
	IA-0PHH-26-WD	26 X 1.5
	IA-0PHH-27-WD	27 X 2.0
	IA-0PHH-33-WD	33 X 2.0
	IA-0PHH-42-WD	42 X 2.0

IA-50HN

METRIC PORT MALE x NPT FEMALE RIGID

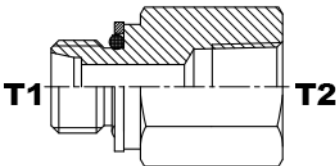
	PART NUMBER	T1	T2
	IA-50HN-10-02	10 X 1.0	1/8 - 27
	IA-50HN-10-04	10 X 1.0	1/4 - 18
	IA-50HN-12-02	12 X 1.5	1/8 - 27
	IA-50HN-12-04	12 X 1.5	1/4 - 18
	IA-50HN-12-06	12 X 1.5	3/8 - 18
	IA-50HN-14-02	14 X 1.5	1/8 - 27
	IA-50HN-14-04	14 X 1.5	1/4 - 18
	IA-50HN-14-06	14 X 1.5	3/8 - 18
	IA-50HN-16-04	16 X 1.5	1/4 - 18
	IA-50HN-16-06	16 X 1.5	3/8 - 18
	IA-50HN-16-08	16 X 1.5	1/2 - 14
	IA-50HN-18-04	18 X 1.5	1/4 - 18
	IA-50HN-18-06	18 X 1.5	3/8 - 18
	IA-50HN-18-08	18 X 1.5	1/2 - 14
	IA-50HN-20-04	20 X 1.5	1/4 - 18
	IA-50HN-20-06	20 X 1.5	3/8 - 18
	IA-50HN-20-08	20 X 1.5	1/2 - 14
	IA-50HN-20-12	20 X 1.5	3/4 - 14
	IA-50HN-22-06	22 X 1.5	3/8 - 18
	IA-50HN-22-08	22 X 1.5	1/2 - 14
	IA-50HN-22-12	22 X 1.5	3/4 - 14
	IA-50HN-24-08	24 X 1.5	1/2 - 14
	IA-50HN-24-12	24 X 1.5	3/4 - 14
	IA-50HN-26-08	26 X 1.5	1/2 - 14
	IA-50HN-26-12	26 X 1.5	3/4 - 14
	IA-50HN-27-12	27 X 2.0	3/4 - 14
	IA-50HN-30-12	30 X 2.0	3/4 - 14
	IA-50HN-30D-08	30 X 1.5	1/2 - 14
	IA-50HN-30D-12	30 X 1.5	3/4 - 14
	IA-50HN-33-16	33 X 2.0	1 - 11 1/2
	IA-50HN-33D-16	33 X 1.5	1 - 11 1/2
	IA-50HN-42-20	42 X 2.0	1 1/4 - 11 1/2
	IA-50HN-48-24	48 X 2.0	1 1/2 - 11 1/2

WARNING This product can expose you to chemicals, which are known to the State of California to cause cancer or birth defects or other reproductive harm. For more information visit <https://www.p65warnings.ca.gov/>



IA-50HN-BS MALE-METRIC PORT W/ BONDED SEAL x NPT FEMALE

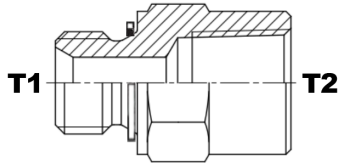

PART NUMBER	T1	T2
IA-50HN-14-06-BS	14 X 1.5	3/8 - 18
IA-50HN-16-06-BS	16 X 1.5	3/8 - 18
IA-50HN-18-06-BS	18 X 1.5	3/8 - 18
IA-50HN-18-08-BS	18 X 1.5	1/2 - 14
IA-50HN-22-04-BS	22 X 1.5	1/4 - 18
IA-50HN-22-06-BS	22 X 1.5	3/8 - 18
IA-50HN-22-08-BS	22 X 1.5	1/2 - 14
IA-50HN-30-08-BS	30 X 2.0	1/2 - 14
IA-50HN-33-16-BS	33 X 2.0	1 - 11 1/2

IA-10JH JIC MALE x METRIC PORT MALE

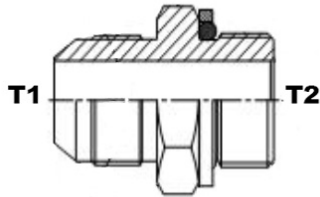

PART NUMBER	T1	T2
IA-10JH-04-10	7/16 - 20	10 X 1.0
IA-10JH-04-12	7/16 - 20	12 X 1.5
IA-10JH-04-14	7/16 - 20	14 X 1.5
IA-10JH-05-12	1/2 - 20	12 X 1.5
IA-10JH-06-12	9/16 - 18	12 X 1.5
IA-10JH-06-14	9/16 - 18	14 X 1.5
IA-10JH-06-16	9/16 - 18	16 X 1.5
IA-10JH-06-18	9/16 - 18	18 X 1.5
IA-10JH-08-12	3/4 - 16	12 X 1.5
IA-10JH-08-14	3/4 - 16	14 X 1.5
IA-10JH-08-16	3/4 - 16	16 X 1.5
IA-10JH-08-18	3/4 - 16	18 X 1.5
IA-10JH-08-20	3/4 - 16	20 X 1.5
IA-10JH-08-22	3/4 - 16	22 X 1.5
IA-10JH-10-16	7/8 - 14	16 X 1.5
IA-10JH-10-18	7/8 - 14	18 X 1.5
IA-10JH-10-20	7/8 - 14	20 X 1.5
IA-10JH-10-22	7/8 - 14	22 X 1.5
IA-10JH-10-24	7/8 - 14	24 X 1.5
IA-10JH-12-22	1 1/16 - 12	22 X 1.5
IA-10JH-12-24	1 1/16 - 12	24 X 1.5
IA-10JH-12-26	1 1/16 - 12	26 X 1.5
IA-10JH-12-27	1 1/16 - 12	27 X 2.0
IA-10JH-12-27A	1 1/16 - 12	27 X 1.5
IA-10JH-16-27	1 5/16 - 12	27 X 2.0
IA-10JH-16-33	1 5/16 - 12	33 X 2.0
IA-10JH-20-42	1 5/8 - 12	42 X 2.0
IA-10JH-24-48	1 7/8 - 12	48 X 2.0

WARNING This product can expose you to chemicals, which are known to the State of California to cause cancer or birth defects or other reproductive harm. For more information visit <https://www.p65warnings.ca.gov/>

IA-10JH-BS

JIC MALE x MALE-METRIC PORT W/ BONDED SEAL

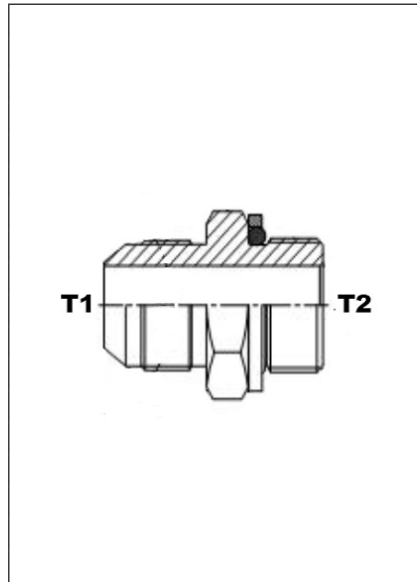

PART NUMBER	T1	T2
IA-10JH-04-10-BS	7/16 - 20	10 X 1.0
IA-10JH-04-12-BS	7/16 - 20	12 X 1.5
IA-10JH-04-14-BS	7/16 - 20	14 X 1.5
IA-10JH-06-12-BS	9/16 - 18	12 X 1.5
IA-10JH-06-14-BS	9/16 - 18	14 X 1.5
IA-10JH-06-16-BS	9/16 - 18	16 X 1.5
IA-10JH-06-18-BS	9/16 - 18	18 X 1.5
IA-10JH-06-22-BS	9/16 - 18	22 X 1.5
IA-10JH-08-18-BS	3/4 - 16	18 X 1.5
IA-10JH-08-22-BS	3/4 - 16	22 X 1.5
IA-10JH-10-20-BS	7/8 - 14	20 X 1.5
IA-10JH-10-22-BS	7/8 - 14	22 X 1.5
IA-10JH-12-22-BS	1 1/16 - 12	22 X 1.5
IA-10JH-12-24-BS	1 1/16 - 12	24 X 1.5
IA-10JH-12-26-BS	1 1/16 - 12	26 X 1.5
IA-10JH-12-27-BS	1 1/16 - 12	27 X 2.0
IA-10JH-16-33-BS	1 5/16 - 12	33 X 2.0

IA-10JH-WD

JIC MALE x MALE-METRIC PORT CAPTIVE SEAL

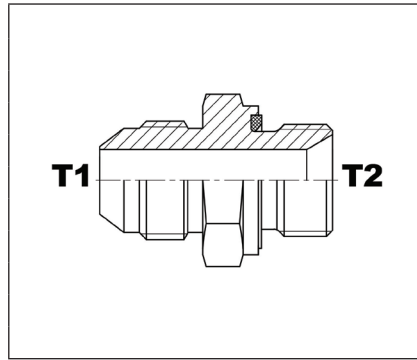

PART NUMBER	T1	T2
IA-10JH-08-20-WD	3/4 - 16	16 X 1.5
IA-10JH-10-22-WD	7/8 - 14	22 X 1.5

IA-14JH

JIC MALE x 45° METRIC PORT MALE ADJ.

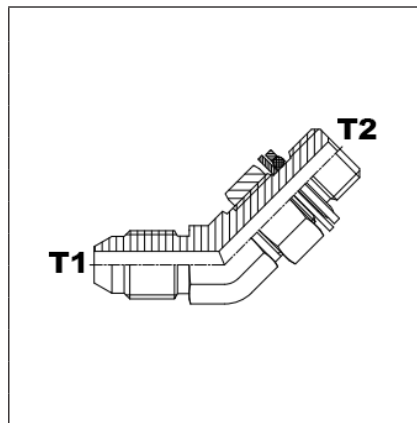

PART NUMBER	T1	T2
IA-14JH-04-10	7/16 - 20	10 X 1.0
IA-14JH-04-12	7/16 - 20	12 X 1.5
IA-14JH-04-14	7/16 - 20	14 X 1.5
IA-14JH-05-12	1/2 - 20	12 X 1.5
IA-14JH-06-14	9/16 - 18	14 X 1.5
IA-14JH-06-16	9/16 - 18	16 X 1.5
IA-14JH-08-16	3/4 - 16	16 X 1.5
IA-14JH-08-18	3/4 - 16	18 X 1.5
IA-14JH-10-18	7/8 - 14	18 X 1.5
IA-14JH-10-22	7/8 - 14	22 X 1.5
IA-14JH-12-22	1 1/16 - 12	22 X 1.5
IA-14JH-12-27	1 1/16 - 12	27 X 2.0

WARNING This product can expose you to chemicals, which are known to the State of California to cause cancer or birth defects or other reproductive harm. For more information visit <https://www.p65warnings.ca.gov/>





IA-19JH

JIC MALE x 90° METRIC PORT MALE ADJ.

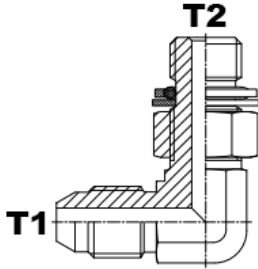

PART NUMBER	T1	T2
IA-19JH-04-10	7/16 - 20	10 X 1.0
IA-19JH-04-12	7/16 - 20	12 X 1.5
IA-19JH-04-14	7/16 - 20	14 X 1.5
IA-19JH-05-10	1/2 - 20	10 X 1.0
IA-19JH-05-12	1/2 - 20	12 X 1.5
IA-19JH-05-14	1/2 - 20	14 X 1.5
IA-19JH-06-12	9/16 - 18	12 X 1.5
IA-19JH-06-14	9/16 - 18	14 X 1.5
IA-19JH-06-16	9/16 - 18	16 X 1.5
IA-19JH-06-18	9/16 - 18	18 X 1.5
IA-19JH-08-14	3/4 - 16	14 X 1.5
IA-19JH-08-16	3/4 - 16	16 X 1.5
IA-19JH-08-18	3/4 - 16	18 X 1.5
IA-19JH-08-20	3/4 - 16	20 X 1.5
IA-19JH-08-22	3/4 - 16	22 X 1.5
IA-19JH-10-16	7/8 - 14	16 X 1.5
IA-19JH-10-18	7/8 - 14	18 X 1.5
IA-19JH-10-20	7/8 - 14	20 X 1.5
IA-19JH-10-22	7/8 - 14	22 X 1.5
IA-19JH-12-22	1 1/16 - 12	22 X 1.5
IA-19JH-12-26	1 1/16 - 12	26 X 1.5
IA-19JH-12-27	1 1/16 - 12	27 X 2.0
IA-19JH-12-33	1 1/16 - 12	33 X 2.0
IA-19JH-16-22	1 5/16 - 12	22 X 1.5
IA-19JH-16-27	1 5/16 - 12	27 X 2.0
IA-19JH-16-33	1 5/16 - 12	33 X 2.0
IA-19JH-20-42	1 5/8 - 12	42 X 2.0
IA-19JH-24-48	1 7/8 - 12	48 X 2.0

IA-AJJH

JIC MALE x METRIC PORT MALE ADJ. BR. TEE

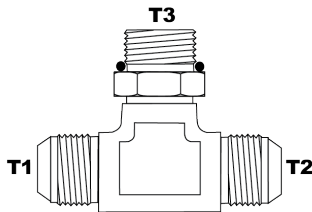

PART NUMBER	T1	T2	T3
IA-AJJH-04-04-10	7/16 - 20	7/16 - 20	10 X 1.0
IA-AJJH-04-04-12	7/16 - 20	7/16 - 20	12 X 1.5
IA-AJJH-06-06-14	9/16 - 18	9/16 - 18	14 X 1.5
IA-AJJH-08-08-16	3/4 - 16	3/4 - 16	16 X 1.5
IA-AJJH-08-08-18	3/4 - 16	3/4 - 16	18 X 1.5
IA-AJJH-10-10-22	7/8 - 14	7/8 - 14	22 X 1.5
IA-AJJH-12-12-27	1 1/16 - 12	1 1/16 - 12	27 X 2.0
IA-AJJH-16-16-33	1 5/16 - 12	1 5/16 - 12	33 X 2.0

WARNING This product can expose you to chemicals, which are known to the State of California to cause cancer or birth defects or other reproductive harm. For more information visit <https://www.p65warnings.ca.gov/>

IA-AJHJ

JIC MALE x METRIC PORT MALE ADJ. RUN TEE

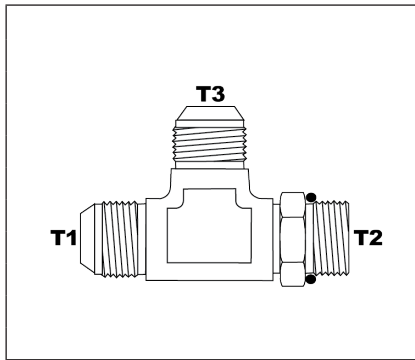

PART NUMBER	T1	T2	T3
IA-AJHJ-04-10-04	7/16 - 20	10 X 1.0	7/16 - 20
IA-AJHJ-04-12-04	7/16 - 20	12 X 1.5	7/16 - 20
IA-AJHJ-06-14-06	9/16 - 18	14 X 1.5	9/16 - 18
IA-AJHJ-08-16-08	3/4 - 16	16 X 1.5	3/4 - 16
IA-AJHJ-08-18-08	3/4 - 16	18 X 1.5	3/4 - 16
IA-AJHJ-10-22-10	7/8 - 14	22 X 1.5	7/8 - 14
IA-AJHJ-12-27-12	1 1/16 - 12	27 X 2.0	1 1/16 - 12
IA-AJHJ-16-33-16	1 5/16 - 12	33 X 2.0	1 5/16 - 12

IA-10FH

ORFS MALE x METRIC PORT MALE

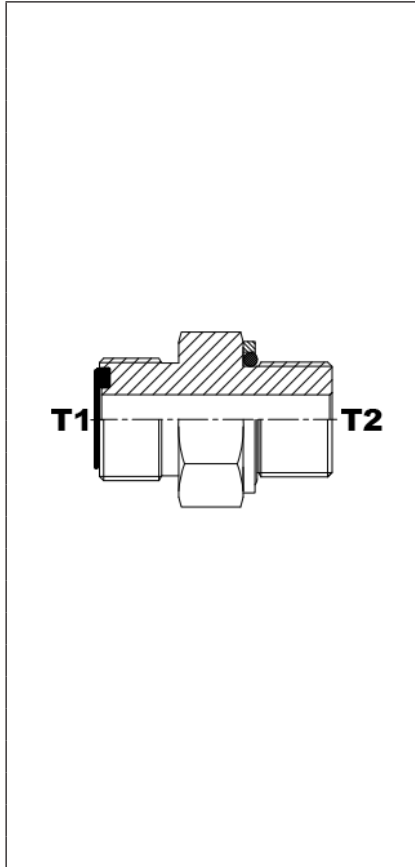

PART NUMBER	T1	T2
IA-10FH-04-10	9/16 - 18	10 X 1.0
IA-10FH-04-12	9/16 - 18	12 X 1.5
IA-10FH-04-14	9/16 - 18	14 X 1.5
IA-10FH-04-16	9/16 - 18	16 X 1.5
IA-10FH-06-12	11/16 - 16	12 X 1.5
IA-10FH-06-14	11/16 - 16	14 X 1.5
IA-10FH-06-16	11/16 - 16	16 X 1.5
IA-10FH-06-18	11/16 - 16	18 X 1.5
IA-10FH-06-22	11/16 - 16	22 X 1.5
IA-10FH-08-14	13/16 - 16	14 X 1.5
IA-10FH-08-16	13/16 - 16	16 X 1.5
IA-10FH-08-18	13/16 - 16	18 X 1.5
IA-10FH-08-22	13/16 - 16	22 X 1.5
IA-10FH-08-26	13/16 - 16	26 X 1.5
IA-10FH-08-27	13/16 - 16	27 X 2.0
IA-10FH-10-18	1 - 14	18 X 1.5
IA-10FH-10-22	1 - 14	22 X 1.5
IA-10FH-12-22	1 3/16 - 12	22 X 1.5
IA-10FH-12-26	1 3/16 - 12	26 X 1.5
IA-10FH-12-27	1 3/16 - 12	27 X 2.0
IA-10FH-12-33	1 3/16 - 12	33 X 2.0
IA-10FH-16-27	1 7/16 - 12	27 X 2.0
IA-10FH-16-33	1 7/16 - 12	33 X 2.0
IA-10FH-20-33	1 11/16 - 12	33 X 2.0
IA-10FH-20-42	1 11/16 - 12	42 X 2.0
IA-10FH-24-48	2 - 12	48 X 2.0

METRIC PORT - DIN 12° SEAT



WARNING This product can expose you to chemicals, which are known to the State of California to cause cancer or birth defects or other reproductive harm. For more information visit <https://www.p65warnings.ca.gov/>

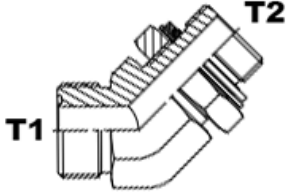

IA-14FH ORFS MALE x 45° METRIC PORT MALE ADJ.

	PART NUMBER	T1	T2
	IA-14FH-04-10	9/16 - 18	10 X 1.0
IA-14FH-06-12	11/16 - 16	12 X 1.5	
IA-14FH-06-14	11/16 - 16	14 X 1.5	
IA-14FH-06-16	11/16 - 16	16 X 1.5	
IA-14FH-08-14	13/16 - 16	14 X 1.5	
IA-14FH-08-16	13/16 - 16	16 X 1.5	
IA-14FH-08-18	13/16 - 16	18 X 1.5	
IA-14FH-10-18	1 - 14	18 X 1.5	
IA-14FH-10-22	1 - 14	22 X 1.5	
IA-14FH-12-22	1 3/16 - 12	22 X 1.5	
IA-14FH-12-26	1 3/16 - 12	26 X 1.5	
IA-14FH-12-27	1 3/16 - 12	27 X 2.0	
IA-14FH-12-33	1 3/16 - 12	33 X 2.0	
IA-14FH-16-33	1 7/16 - 12	33 X 2.0	

IA-19FH ORFS MALE x 90° METRIC PORT MALE ADJ.

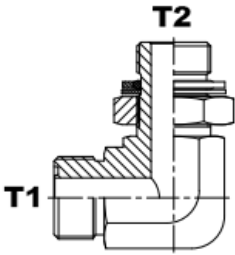
	PART NUMBER	T1	T2
	IA-19FH-04-10	9/16 - 18	10 X 1.0
IA-19FH-04-12	9/16 - 18	12 X 1.5	
IA-19FH-04-14	9/16 - 18	14 X 1.5	
IA-19FH-06-12	11/16 - 16	12 X 1.5	
IA-19FH-06-14	11/16 - 16	14 X 1.5	
IA-19FH-06-16	11/16 - 16	16 X 1.5	
IA-19FH-08-14	13/16 - 16	14 X 1.5	
IA-19FH-08-16	13/16 - 16	16 X 1.5	
IA-19FH-08-18	13/16 - 16	18 X 1.5	
IA-19FH-08-22	13/16 - 16	22 X 1.5	
IA-19FH-10-18	1 - 14	18 X 1.5	
IA-19FH-10-22	1 - 14	22 X 1.5	
IA-19FH-12-27	1 3/16 - 12	27 X 2.0	
IA-19FH-12-33	1 3/16 - 12	33 X 2.0	
IA-19FH-16-33	1 7/16 - 12	33 X 2.0	
IA-19FH-20-33	1 11/16 - 12	33 X 2.0	
IA-19FH-20-42	1 11/16 - 12	42 X 2.0	

IA-AFFH ORFS MALE x METRIC PORT MALE ADJ. BR. TEE

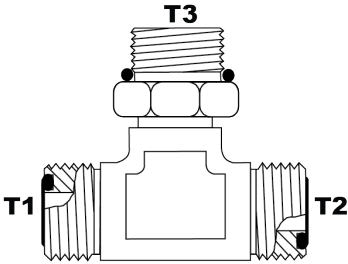
	PART NUMBER	T1	T2	T3
	IA-AFFH-04-04-10	9/16 - 18	9/16 - 18	10 X 1.0
IA-AFFH-04-04-12	9/16 - 18	9/16 - 18	12 X 1.5	
IA-AFFH-04-04-14	9/16 - 18	9/16 - 18	14 X 1.5	
IA-AFFH-06-06-14	11/16 - 16	11/16 - 16	14 X 1.5	
IA-AFFH-06-06-16	11/16 - 16	11/16 - 16	16 X 1.5	
IA-AFFH-08-08-16	13/16 - 16	13/16 - 16	16 X 1.5	
IA-AFFH-08-08-18	13/16 - 16	13/16 - 16	18 X 1.5	
IA-AFFH-08-08-22	13/16 - 16	13/16 - 16	22 X 1.5	
IA-AFFH-10-10-22	1 - 14	1 - 14	22 X 1.5	
IA-AFFH-12-12-27	1 3/16 - 12	1 3/16 - 12	27 X 2.0	
IA-AFFH-16-16-33	1 7/16 - 12	1 7/16 - 12	33 X 2.0	

⚠ WARNING This product can expose you to chemicals, which are known to the State of California to cause cancer or birth defects or other reproductive harm. For more information visit <https://www.p65warnings.ca.gov/>

IA-AFHF

ORFS MALE x METRIC PORT MALE ADJ. RUN TEE

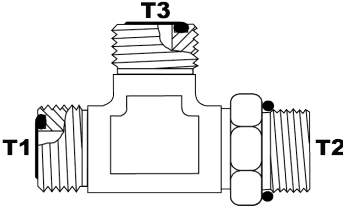
	PART NUMBER	T1	T2	T3
	IA-AFHF-04-10-04	9/16 - 18	10 X 1.0	9/16 - 18
IA-AFHF-04-12-04	9/16 - 18	12 X 1.5	9/16 - 18	
IA-AFHF-04-14-04	9/16 - 18	14 X 1.5	9/16 - 18	
IA-AFHF-06-14-06	11/16 - 16	14 X 1.5	11/16 - 16	
IA-AFHF-06-16-06	11/16 - 16	16 X 1.5	11/16 - 16	
IA-AFHF-08-16-08	13/16 - 16	16 X 1.5	13/16 - 16	
IA-AFHF-08-18-08	13/16 - 16	18 X 1.5	13/16 - 16	
IA-AFHF-08-22-08	13/16 - 16	22 X 1.5	13/16 - 16	
IA-AFHF-10-22-10	1 - 14	22 X 1.5	1 - 14	
IA-AFHF-12-27-12	1 3/16 - 12	27 X 2.0	1 3/16 - 12	
IA-AFHF-16-33-16	1 7/16 - 12	33 X 2.0	1 7/16 - 12	

IA-10NH

NPT MALE x MALE-METRIC PORT

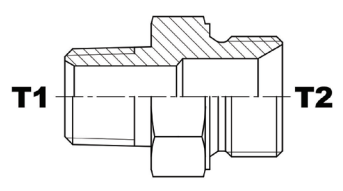
	PART NUMBER	T1	T2
	IA-10NH-02-10	1/8 - 27	10 X 1.0
IA-10NH-02-12	1/8 - 27	12 X 1.5	
IA-10NH-04-10	1/4 - 18	10 X 1.0	
IA-10NH-04-12	1/4 - 18	12 X 1.5	
IA-10NH-04-14	1/4 - 18	14 X 1.5	
IA-10NH-08-16	1/2 - 14	16 X 1.5	
IA-10NH-16-30	1 - 11 1/2	30 X 2.0	

IA-50HN-DP

MALE-METRIC DUAL PURPOSE x NPT FEMALE

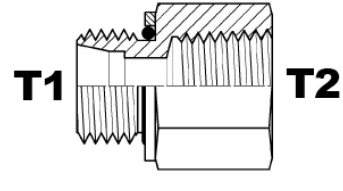
	PART NUMBER	T1	T2
	IA-50HN-12-L06-04	12 X 1.5 / L06	1/4 - 18
IA-50HN-12-L06-06	12 X 1.5 / L06	3/8 - 18	
IA-50HN-14-L08-04	14 X 1.5 / L08	1/4 - 18	
IA-50HN-14-L08-06	14 X 1.5 / L08	3/8 - 18	
IA-50HN-16-L10-04	16 X 1.5 / L10	1/4 - 18	
IA-50HN-16-L10-06	16 X 1.5 / L10	3/8 - 18	
IA-50HN-16-L10-08	16 X 1.5 / L10	1/2 - 14	
IA-50HN-18-L12-04	18 X 1.5 / L12	1/4 - 18	
IA-50HN-18-L12-06	18 X 1.5 / L12	3/8 - 18	
IA-50HN-18-L12-08	18 X 1.5 / L12	1/2 - 14	
IA-50HN-22-L15-06	22 X 1.5 / L15	3/8 - 18	
IA-50HN-22-L15-08	22 X 1.5 / L15	1/2 - 14	
IA-50HN-22-L15-12	22 X 1.5 / L15	3/4 - 14	
IA-50HN-26-L18-12	26 X 1.5 / L18	3/4 - 14	
IA-50HN-30-L22-12	30 X 2.0 / L22	3/4 - 14	
IA-50HN-14-S06-06	14 X 1.5 / S06	3/8 - 18	
IA-50HN-20-S12-04	20 X 1.5 / S12	1/4 - 18	
IA-50HN-24-S16-12	24 X 1.5 / S16	3/4 - 14	
IA-50HN-42-S30-16	42 X 2.0 / S30	1 - 11 1/2	
IA-50HN-42-S30-20	42 X 2.0 / S30	1 1/4 - 11 1/2	

WARNING This product can expose you to chemicals, which are known to the State of California to cause cancer or birth defects or other reproductive harm. For more information visit <https://www.p65warnings.ca.gov/>

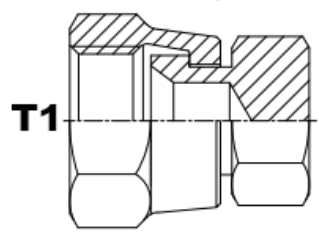

IA-0CS JIS FEMALE CAP

	PART NUMBER	T1
	IA-0CS-02	1/8 - 28
	IA-0CS-04	1/4 - 19
	IA-0CS-06	3/8 - 19
	IA-0CS-08	1/2 - 14
	IA-0CS-12	3/4 - 14
	IA-0CS-16	1 - 11
	IA-0CS-20	1 1/4 - 11
	IA-0CS-24	1 1/2 - 11
	IA-0CS-32	2 - 11

IA-0PS JIS MALE PLUG

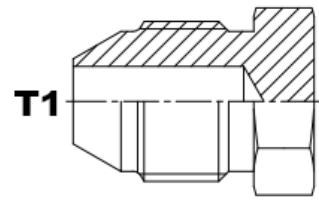
	PART NUMBER	T1
	IA-0PS-02	1/8 - 28
	IA-0PS-04	1/4 - 19
	IA-0PS-06	3/8 - 19
	IA-0PS-08	1/2 - 14
	IA-0PS-10	5/8 - 14
	IA-0PS-12	3/4 - 14
	IA-0PS-16	1 - 11
	IA-0PS-20	1 1/4 - 11
	IA-0PS-24	1 1/2 - 11

IA-10SS JIS MALE UNION

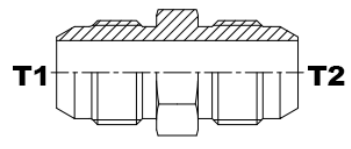
	PART NUMBER	T1	T2
	IA-10SS-04-04	1/4 - 19	1/4 - 19
	IA-10SS-06-06	3/8 - 19	3/8 - 19
	IA-10SS-08-08	1/2 - 14	1/2 - 14
	IA-10SS-12-12	3/4 - 14	3/4 - 14
	IA-10SS-16-16	1 - 11	1 - 11
	IA-10SS-20-20	1 1/4 - 11	1 1/4 - 11

IA-60SS JIS MALE BULKHEAD UNION

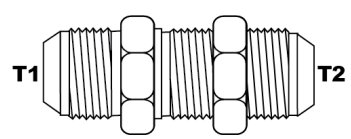
	PART NUMBER	T1	T2
	IA-60SS-04-04	1/4 - 19	1/4 - 19
	IA-60SS-06-06	3/8 - 19	3/8 - 19
	IA-60SS-08-08	1/2 - 14	1/2 - 14
	IA-60SS-12-12	3/4 - 14	3/4 - 14
	IA-60SS-16-16	1 - 11	1 - 11

⚠ WARNING This product can expose you to chemicals, which are known to the State of California to cause cancer or birth defects or other reproductive harm. For more information visit <https://www.p65warnings.ca.gov/>

IA-69SS 90° JIS MALE BULKHEAD UNION

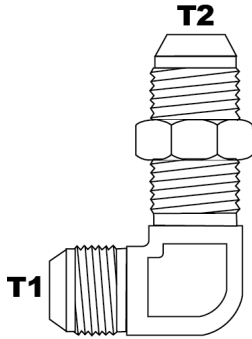
	PART NUMBER	T1	T2
	IA-69SS-04-04	1/4 - 19	1/4 - 19
	IA-69SS-06-06	3/8 - 19	3/8 - 19
	IA-69SS-08-08	1/2 - 14	1/2 - 14
	IA-69SS-12-12	3/4 - 14	3/4 - 14
	IA-69SS-16-16	1 - 11	1 - 11

IA-20SS JIS MALE x FEMALE SWIVEL

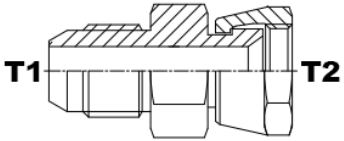
	PART NUMBER	T1	T2
	IA-20SS-02-02	1/8 - 28	1/8 - 28
	IA-20SS-04-04	1/4 - 19	1/4 - 19
	IA-20SS-06-06	3/8 - 19	3/8 - 19
	IA-20SS-08-08	1/2 - 14	1/2 - 14
	IA-20SS-12-12	3/4 - 14	3/4 - 14
	IA-20SS-16-16	1 - 11	1 - 11
	IA-20SS-20-20	1 1/4 - 11	1 1/4 - 11
	IA-20SS-24-24	1 1/2 - 11	1 1/2 - 11

IA-24SS JIS MALE x 45° FEMALE SWIVEL

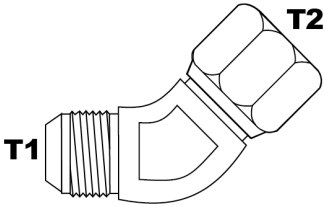
	PART NUMBER	T1	T2
	IA-24SS-02-02	1/8 - 28	1/8 - 28
	IA-24SS-04-04	1/4 - 19	1/4 - 19
	IA-24SS-06-06	3/8 - 19	3/8 - 19
	IA-24SS-08-08	1/2 - 14	1/2 - 14
	IA-24SS-12-12	3/4 - 14	3/4 - 14
	IA-24SS-16-16	1 - 11	1 - 11
	IA-24SS-20-20	1 1/4 - 11	1 1/4 - 11
	IA-24SS-24-24	1 1/2 - 11	1 1/2 - 11

IA-29SS 90° JIS MALE x FEMALE SWIVEL

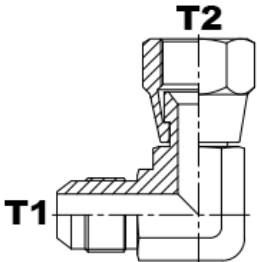
	PART NUMBER	T1	T2
	IA-29SS-04-04	1/4 - 19	1/4 - 19
	IA-29SS-06-06	3/8 - 19	3/8 - 19
	IA-29SS-08-08	1/2 - 14	1/2 - 14
	IA-29SS-12-12	3/4 - 14	3/4 - 14
	IA-29SS-16-16	1 - 11	1 - 11

WARNING This product can expose you to chemicals, which are known to the State of California to cause cancer or birth defects or other reproductive harm. For more information visit <https://www.p65warnings.ca.gov/>

IA-BSSS JIS MALE x FEMALE SWIVEL BR. TEE

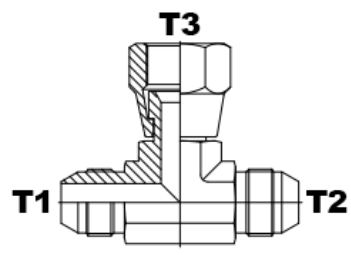
	PART NUMBER	T1	T2	T3
	IA-BSSS-04-04-04	1/4 - 19	1/4 - 19	1/4 - 19
	IA-BSSS-06-06-06	3/8 - 19	3/8 - 19	3/8 - 19
	IA-BSSS-08-08-08	1/2 - 14	1/2 - 14	1/2 - 14
	IA-BSSS-12-12-12	3/4 - 14	3/4 - 14	3/4 - 14
	IA-BSSS-16-16-16	1 - 11	1 - 11	1 - 11

IA-CSSS JIS MALE x FEMALE SWIVEL RUN TEE

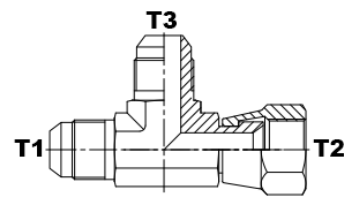
	PART NUMBER	T1	T2	T3
	IA-CSSS-02-02-02	1/8 - 28	1/8 - 28	1/8 - 28
	IA-CSSS-04-04-04	1/4 - 19	1/4 - 19	1/4 - 19
	IA-CSSS-06-06-06	3/8 - 19	3/8 - 19	3/8 - 19
	IA-CSSS-08-08-08	1/2 - 14	1/2 - 14	1/2 - 14
	IA-CSSS-12-12-12	3/4 - 14	3/4 - 14	3/4 - 14
IA-CSSS-16-16-16	1 - 11	1 - 11	1 - 11	

IA-10ST JIS MALE x BSPT MALE

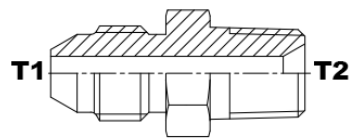
	PART NUMBER	T1	T2
	IA-10ST-02-02	1/8 - 28	1/8 - 28
	IA-10ST-02-04	1/8 - 28	1/4 - 19
	IA-10ST-04-02	1/4 - 19	1/8 - 28
	IA-10ST-04-04	1/4 - 19	1/4 - 19
	IA-10ST-04-06	1/4 - 19	3/8 - 19
	IA-10ST-06-04	3/8 - 19	1/4 - 19
	IA-10ST-06-06	3/8 - 19	3/8 - 19
	IA-10ST-06-08	3/8 - 19	1/2 - 14
	IA-10ST-08-06	1/2 - 14	3/8 - 19
	IA-10ST-08-08	1/2 - 14	1/2 - 14
	IA-10ST-08-12	1/2 - 14	3/4 - 14
	IA-10ST-12-12	3/4 - 14	3/4 - 14
	IA-10ST-16-16	1 - 11	1 - 11
	IA-10ST-20-20	1 1/4 - 11	1 1/4 - 11
	IA-10ST-24-24	1 1/2 - 11	1 1/2 - 11
IA-10ST-32-32	2 - 11	2 - 11	

⚠ WARNING This product can expose you to chemicals, which are known to the State of California to cause cancer or birth defects or other reproductive harm. For more information visit <https://www.p65warnings.ca.gov/>

IA-14ST JIS MALE x 45° BSPT MALE

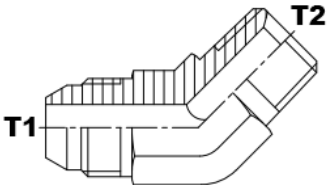
	PART NUMBER	T1	T2
	IA-14ST-02-02	1/8 - 28	1/8 - 28
	IA-14ST-04-04	1/4 - 19	1/4 - 19
	IA-14ST-06-06	3/8 - 19	3/8 - 19
	IA-14ST-08-08	1/2 - 14	1/2 - 14
	IA-14ST-12-12	3/4 - 14	3/4 - 14
	IA-14ST-16-16	1 - 11	1 - 11
	IA-14ST-20-20	1 1/4 - 11	1 1/4 - 11

IA-19ST JIS MALE x 90° BSPT MALE

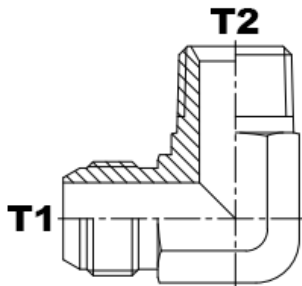
	PART NUMBER	T1	T2
	IA-19ST-02-02	1/8 - 28	1/8 - 28
	IA-19ST-04-02	1/4 - 19	1/8 - 28
	IA-19ST-04-04	1/4 - 19	1/4 - 19
	IA-19ST-04-06	1/4 - 19	3/8 - 19
	IA-19ST-06-04	3/8 - 19	1/4 - 19
	IA-19ST-06-06	3/8 - 19	3/8 - 19
	IA-19ST-06-08	3/8 - 19	1/2 - 14
	IA-19ST-08-08	1/2 - 14	1/2 - 14
	IA-19ST-12-12	3/4 - 14	3/4 - 14
	IA-19ST-16-16	1 - 11	1 - 11
	IA-19ST-20-20	1 1/4 - 11	1 1/4 - 11
	IA-19ST-24-24	1 1/2 - 11	1 1/2 - 11
	IA-19ST-32-32	2 - 11	2 - 11

IA-20TS BSPT MALE x JIS FEMALE SWIVEL

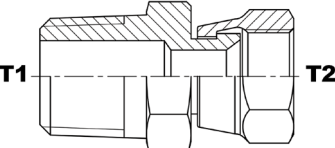
	PART NUMBER	T1	T2
	IA-20TS-04-04	1/4 - 19	1/4 - 19
	IA-20TS-06-06	3/8 - 19	3/8 - 19
	IA-20TS-08-08	1/2 - 14	1/2 - 14
	IA-20TS-12-12	3/4 - 14	3/4 - 14
	IA-20TS-16-16	1 - 11	1 - 11
	IA-20TS-20-20	1 1/4 - 11	1 1/4 - 11
	IA-20TS-24-24	1 1/2 - 11	1 1/2 - 11
	IA-20TS-32-32	2 - 11	2 - 11

WARNING This product can expose you to chemicals, which are known to the State of California to cause cancer or birth defects or other reproductive harm. For more information visit <https://www.p65warnings.ca.gov/>

IA-50ST JIS MALE x BSPT FEMALE RIGID

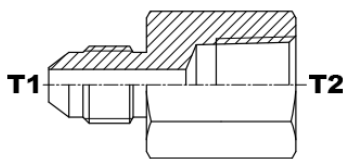
	PART NUMBER	T1	T2
	IA-50ST-04-04	1/4 - 19	1/4 - 19
	IA-50ST-06-06	3/8 - 19	3/8 - 19
	IA-50ST-08-08	1/2 - 14	1/2 - 14
	IA-50ST-12-12	3/4 - 14	3/4 - 14

IA-10SB JIS MALE x BSPP MALE 60° SEAT

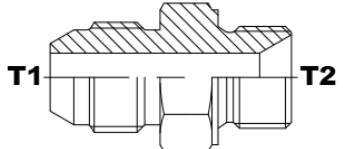
	PART NUMBER	T1	T2
	IA-10SB-04-04	1/4 - 19	1/4 - 19
	IA-10SB-06-06	3/8 - 19	3/8 - 19
	IA-10SB-08-08	1/2 - 14	1/2 - 14
	IA-10SB-12-12	3/4 - 14	3/4 - 14
IA-10SB-16-16	1 - 11	1 - 11	

IA-10SG JIS MALE x BSPP MALE PORT

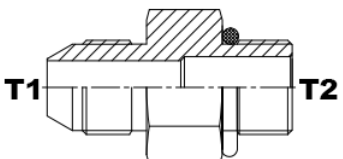
	PART NUMBER	T1	T2
	IA-10SG-04-04	1/4 - 19	1/4 - 19
	IA-10SG-04-06	1/4 - 19	3/8 - 19
	IA-10SG-06-06	3/8 - 19	3/8 - 19
	IA-10SG-06-08	3/8 - 19	1/2 - 14
	IA-10SG-08-08	1/2 - 14	1/2 - 14
	IA-10SG-12-12	3/4 - 14	3/4 - 14
	IA-10SG-16-16	1 - 11	1 - 11

IA-14SG 45° JIS MALE x BSPP PORT ADJ. MALE

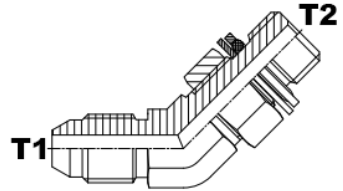
	PART NUMBER	T1	T2
	IA-14SG-04-04	1/4 - 19	1/4 - 19
	IA-14SG-06-06	3/8 - 19	3/8 - 19
	IA-14SG-08-08	1/2 - 14	1/2 - 14
	IA-14SG-12-12	3/4 - 14	3/4 - 14
IA-14SG-16-16	1 - 11	1 - 11	

⚠ WARNING This product can expose you to chemicals, which are known to the State of California to cause cancer or birth defects or other reproductive harm. For more information visit <https://www.p65warnings.ca.gov/>

IA-19SG

JIS MALE x 90° BSPP PORT MALE ADJ.

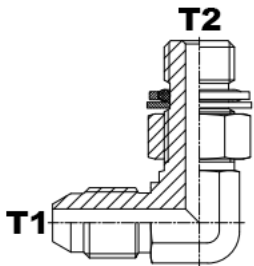
	PART NUMBER	T1	T2
	IA-19SG-04-04	1/4 - 19	1/4 - 19
	IA-19SG-04-06	1/4 - 19	3/8 - 19
	IA-19SG-06-06	3/8 - 19	3/8 - 19
	IA-19SG-06-08	3/8 - 19	1/2 - 14
	IA-19SG-08-08	1/2 - 14	1/2 - 14
	IA-19SG-12-12	3/4 - 14	3/4 - 14
	IA-19SG-16-16	1 - 11	1 - 11

IA-ASSG

JIS MALE x BSPP PORT MALE ADJ. BR. TEE

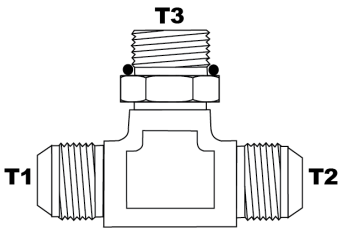
	PART NUMBER	T1	T2	T3
	IA-ASSG-04-04-04	1/4 - 19	1/4 - 19	1/4 - 19
	IA-ASSG-06-06-06	3/8 - 19	3/8 - 19	3/8 - 19
	IA-ASSG-08-08-08	1/2 - 14	1/2 - 14	1/2 - 14
	IA-ASSG-12-12-12	3/4 - 14	3/4 - 14	3/4 - 14
	IA-ASSG-16-16-16	1 - 11	1 - 11	1 - 11

IA-ASGS

JIS MALE x BSPP PORT MALE ADJ. RUN TEE

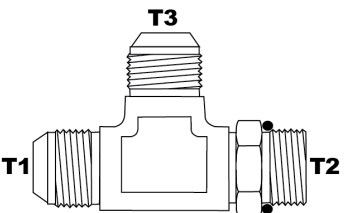
	PART NUMBER	T1	T2	T3
	IA-ASGS-04-04-04	1/4 - 19	1/4 - 19	1/4 - 19
	IA-ASGS-06-06-06	3/8 - 19	3/8 - 19	3/8 - 19
	IA-ASGS-08-08-08	1/2 - 14	1/2 - 14	1/2 - 14
	IA-ASGS-12-12-12	3/4 - 14	3/4 - 14	3/4 - 14
	IA-ASGS-16-16-16	1 - 11	1 - 11	1 - 11

IA-10SO

JIS MALE x ORB MALE

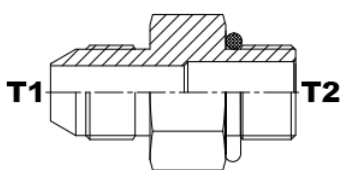
	PART NUMBER	T1	T2
	IA-10SO-04-04	1/4 - 19	7/16 - 20
	IA-10SO-04-06	1/4 - 19	9/16 - 18
	IA-10SO-06-04	3/8 - 19	7/16 - 20
	IA-10SO-06-06	3/8 - 19	9/16 - 18
	IA-10SO-06-08	3/8 - 19	3/4 - 16
	IA-10SO-08-06	1/2 - 14	9/16 - 18
	IA-10SO-08-08	1/2 - 14	3/4 - 16
	IA-10SO-12-12	3/4 - 14	1 1/16 - 12
	IA-10SO-16-16	1 - 11	1 5/16 - 12

WARNING This product can expose you to chemicals, which are known to the State of California to cause cancer or birth defects or other reproductive harm. For more information visit <https://www.p65warnings.ca.gov/>

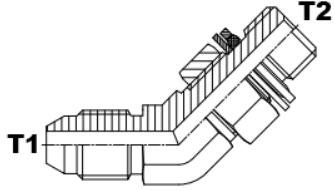

IA-14SO JIC MALE x 45° M-ORB ADJ.

	PART NUMBER	T1	T2
	IA-14SO-04-04	1/4 - 19	7/16 - 20
	IA-14SO-04-06	1/4 - 19	9/16 - 18
	IA-14SO-06-04	3/8 - 19	7/16 - 20
	IA-14SO-06-06	3/8 - 19	9/16 - 18
	IA-14SO-06-08	3/8 - 19	3/4 - 16
	IA-14SO-08-08	1/2 - 14	3/4 - 16

IA-19SO JIS MALE x 90° M-ORB ADJ.

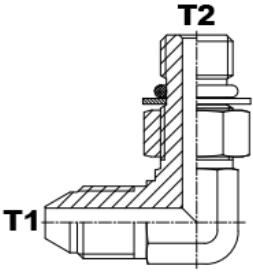
	PART NUMBER	T1	T2
	IA-19SO-04-04	1/4 - 19	7/16 - 20
	IA-19SO-04-06	1/4 - 19	9/16 - 18
	IA-19SO-06-06	3/8 - 19	9/16 - 18
	IA-19SO-06-08	3/8 - 19	3/4 - 16
	IA-19SO-08-06	1/2 - 14	9/16 - 18
	IA-19SO-08-08	1/2 - 14	3/4 - 16

IA-ASSO JIS MALE x M-ORB ADJ. BR. TEE

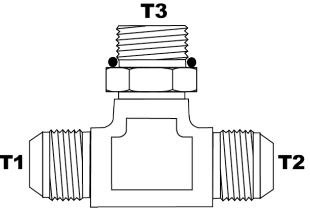
	PART NUMBER	T1	T2	T3
	IA-ASSO-04-04-04	1/4 - 19	1/4 - 19	7/16 - 20
	IA-ASSO-06-06-06	3/8 - 19	3/8 - 19	9/16 - 18
	IA-ASSO-08-08-08	1/2 - 14	1/2 - 14	3/4 - 16
	IA-ASSO-12-12-12	3/4 - 14	3/4 - 14	1 1/16 - 12
	IA-ASSO-16-16-16	1 - 11	1 - 11	1 5/16 - 12

IA-ASOS JIS MALE x M-ORB ADJ. RUN TEE

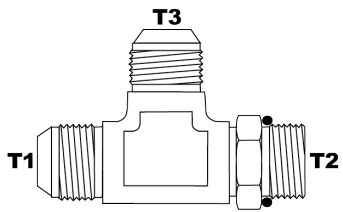
	PART NUMBER	T1	T2	T3
	IA-ASOS-04-04-04	1/4 - 19	7/16 - 20	1/4 - 19
	IA-ASOS-06-06-06	3/8 - 19	9/16 - 18	3/8 - 19
	IA-ASOS-08-08-08	1/2 - 14	3/4 - 16	1/2 - 14
	IA-ASOS-12-12-12	3/4 - 14	1 1/16 - 12	3/4 - 14
	IA-ASOS-16-16-16	1 - 11	1 5/16 - 12	1 - 11

⚠ WARNING This product can expose you to chemicals, which are known to the State of California to cause cancer or birth defects or other reproductive harm. For more information visit <https://www.p65warnings.ca.gov/>

IA-200S

M-ORB x JIS FEMALE SWIVEL

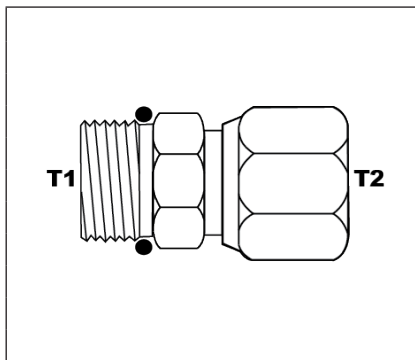

PART NUMBER	T1	T2
IA-200S-04-04	7/16 - 20	1/4 - 19
IA-200S-04-06	7/16 - 20	3/8 - 19
IA-200S-06-06	9/16 - 18	3/8 - 19
IA-200S-06-08	9/16 - 18	1/2 - 14
IA-200S-08-08	3/4 - 16	1/2 - 14
IA-200S-10-12	7/8 - 14	3/4 - 14
IA-200S-12-12	1 1/16 - 12	3/4 - 14
IA-200S-12-16	1 1/16 - 12	1 - 11
IA-200S-16-16	1 5/16 - 12	1 - 11

IA-10SN

JIS MALE x NPT MALE

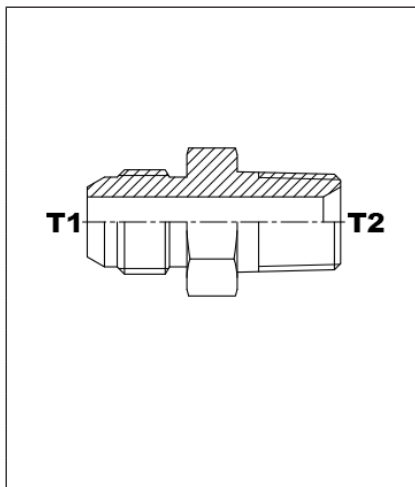

PART NUMBER	T1	T2
IA-10SN-04-02	1/4 - 19	1/8 - 27
IA-10SN-04-04	1/4 - 19	1/4 - 18
IA-10SN-06-04	3/8 - 19	1/4 - 18
IA-10SN-06-06	3/8 - 19	3/8 - 18
IA-10SN-06-08	3/8 - 19	1/2 - 14
IA-10SN-08-06	1/2 - 14	3/8 - 18
IA-10SN-08-08	1/2 - 14	1/2 - 14
IA-10SN-12-08	3/4 - 14	1/2 - 14
IA-10SN-12-12	3/4 - 14	3/4 - 14
IA-10SN-16-12	1 - 11	3/4 - 14
IA-10SN-16-16	1 - 11	1 - 11 1/2
IA-10SN-20-16	1 1/4 - 11	1 - 11 1/2
IA-10SN-20-20	1 1/4 - 11	1 1/4 - 11 1/2
IA-10SN-24-24	1 1/2 - 11	1 1/2 - 11 1/2

IA-19SN

JIS MALE x 90° NPT MALE

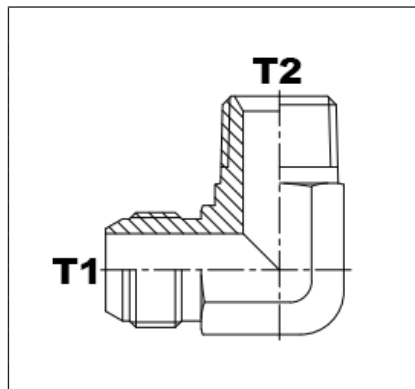

PART NUMBER	T1	T2
IA-19SN-04-04	1/4 - 19	1/4 - 18
IA-19SN-06-04	3/8 - 19	1/4 - 18
IA-19SN-06-06	3/8 - 19	3/8 - 18
IA-19SN-08-06	1/2 - 14	3/8 - 18
IA-19SN-08-08	1/2 - 14	1/2 - 14
IA-19SN-12-08	3/4 - 14	1/2 - 14
IA-19SN-12-12	3/4 - 14	3/4 - 14
IA-19SN-16-12	1 - 11	3/4 - 14
IA-19SN-16-16	1 - 11	1 - 11 1/2
IA-19SN-20-16	1 1/4 - 11	1 - 11 1/2
IA-19SN-20-20	1 1/4 - 11	1 1/4 - 11 1/2

WARNING This product can expose you to chemicals, which are known to the State of California to cause cancer or birth defects or other reproductive harm. For more information visit <https://www.p65warnings.ca.gov/>

IA-20NS NPT MALE x JIS FEMALE SWIVEL

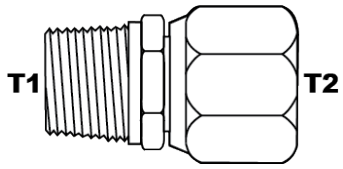
	PART NUMBER	T1	T2
	IA-20NS-04-04	1/4 - 18	1/4 - 19
	IA-20NS-06-06	3/8 - 18	3/8 - 19
	IA-20NS-08-08	1/2 - 14	1/2 - 14
	IA-20NS-12-12	3/4 - 14	3/4 - 14
	IA-20NS-16-16	1 - 11 1/2	1 - 11

IA-10JS JIC MALE x JIS MALE

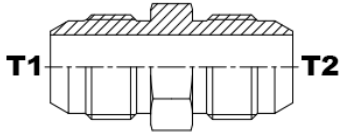
	PART NUMBER	T1	T2
	IA-10JS-04-04	7/16 - 20	1/4 - 19
	IA-10JS-06-06	9/16 - 18	3/8 - 19
	IA-10JS-08-08	3/4 - 16	1/2 - 14
	IA-10JS-12-12	1 1/16 - 12	3/4 - 14
	IA-10JS-16-16	1 5/16 - 12	1 - 11

IA-20SJ JIS MALE x JIC FEMALE SWIVEL

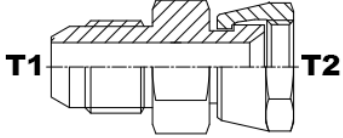
	PART NUMBER	T1	T2
	IA-20SJ-04-04	1/4 - 19	7/16 - 20
	IA-20SJ-06-04	3/8 - 19	7/16 - 20
	IA-20SJ-06-06	3/8 - 19	9/16 - 18
	IA-20SJ-08-06	1/2 - 14	9/16 - 18
	IA-20SJ-08-08	1/2 - 14	3/4 - 16
	IA-20SJ-12-10	3/4 - 14	7/8 - 14
	IA-20SJ-12-12	3/4 - 14	1 1/16 - 12
	IA-20SJ-16-12	1 - 11	1 1/16 - 12
	IA-20SJ-16-16	1 - 11	1 5/16 - 12
	IA-20SJ-20-20	1 1/4 - 11	1 5/8 - 12

IA-20JS JIC MALE x JIS FEMALE SWIVEL

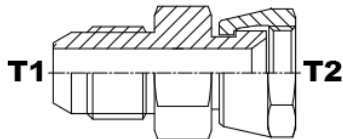
	PART NUMBER	T1	T2
	IA-20JS-04-04	7/16 - 20	1/4 - 19
	IA-20JS-06-06	9/16 - 18	3/8 - 19
	IA-20JS-08-08	3/4 - 16	1/2 - 14
	IA-20JS-12-12	1 1/16 - 12	3/4 - 14
	IA-20JS-16-16	1 5/16 - 12	1 - 11

⚠ WARNING This product can expose you to chemicals, which are known to the State of California to cause cancer or birth defects or other reproductive harm. For more information visit <https://www.p65warnings.ca.gov/>

IA-50JS

JIC MALE x JIS FEMALE

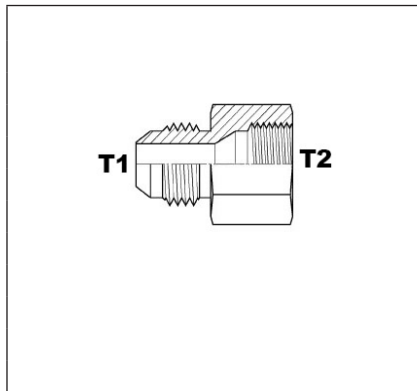

PART NUMBER	T1	T2
IA-50JS-04-04	7/16 - 20	1/4 - 19
IA-50JS-06-04	9/16 - 18	1/4 - 19
IA-50JS-06-06	9/16 - 18	3/8 - 19
IA-50JS-08-06	3/4 - 16	3/8 - 19
IA-50JS-08-08	3/4 - 16	1/2 - 14
IA-50JS-12-12	1 1/16 - 12	3/4 - 14
IA-50JS-16-16	1 5/16 - 12	1 - 11

IA-10FS

ORFS MALE x JIS MALE

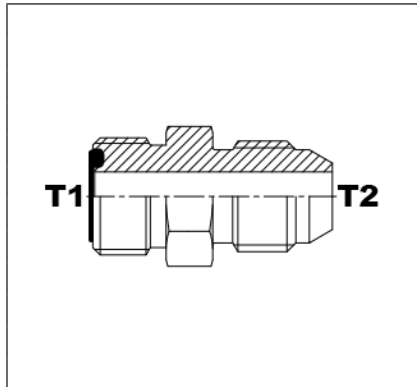

PART NUMBER	T1	T2
IA-10FS-04-04	9/16 - 18	1/4 - 19
IA-10FS-06-06	11/16 - 16	3/8 - 19
IA-10FS-08-08	13/16 - 16	1/2 - 14
IA-10FS-12-12	1 3/16 - 12	3/4 - 14
IA-10FS-16-16	1 7/16 - 12	1 - 11

IA-20FS

ORFS MALE x JIS FEMALE SWIVEL

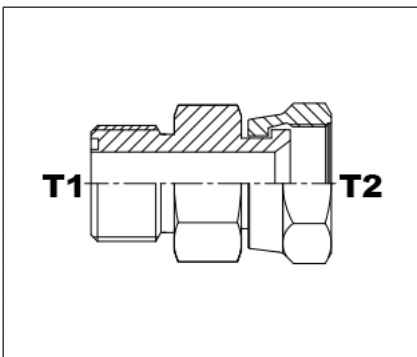

PART NUMBER	T1	T2
IA-20FS-04-04	9/16 - 18	1/4 - 19
IA-20FS-06-06	11/16 - 16	3/8 - 19
IA-20FS-08-08	13/16 - 16	1/2 - 14
IA-20FS-12-12	1 3/16 - 12	3/4 - 14
IA-20FS-16-16	1 7/16 - 12	1 - 11

WARNING This product can expose you to chemicals, which are known to the State of California to cause cancer or birth defects or other reproductive harm. For more information visit <https://www.p65warnings.ca.gov/>

IA-0CK KOMATSU® FEMALE CAP

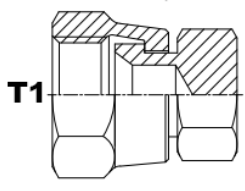
	PART NUMBER	T1
	IA-0CK-14	14 X 1.5
	IA-0CK-16	16 X 1.5
	IA-0CK-18	18 X 1.5
	IA-0CK-20	20 X 1.5
	IA-0CK-22	22 X 1.5
	IA-0CK-24	24 X 1.5
	IA-0CK-30	30 X 1.5
	IA-0CK-33	33 X 1.5
	IA-0CK-42	42 X 1.5

IA-0PK KOMATSU® MALE PLUG

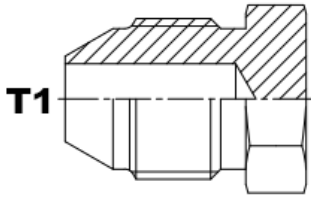
	PART NUMBER	T1
	IA-0PK-14	14 X 1.5
	IA-0PK-16	16 X 1.5
	IA-0PK-18	18 X 1.5
	IA-0PK-22	22 X 1.5
	IA-0PK-24	24 X 1.5
	IA-0PK-30	30 X 1.5
	IA-0PK-33	33 X 1.5
	IA-0PK-42	42 X 1.5

IA-10KK KOMATSU® MALE UNION

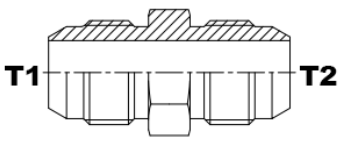
	PART NUMBER	T1	T2
	IA-10KK-14-14	14 X 1.5	14 X 1.5
	IA-10KK-16-16	16 X 1.5	16 X 1.5
	IA-10KK-18-18	18 X 1.5	18 X 1.5
	IA-10KK-20-20	20 X 1.5	20 X 1.5
	IA-10KK-22-22	22 X 1.5	22 X 1.5
	IA-10KK-24-24	24 X 1.5	24 X 1.5
	IA-10KK-30-30	30 X 1.5	30 X 1.5
	IA-10KK-33-33	33 X 1.5	33 X 1.5

IA-19KK 90° KOMATSU® MALE UNION

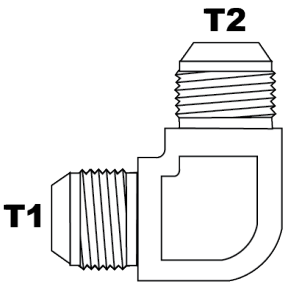
	PART NUMBER	T1	T2
	IA-19KK-14-14	14 X 1.5	14 X 1.5
	IA-19KK-16-16	16 X 1.5	16 X 1.5
	IA-19KK-18-18	18 X 1.5	18 X 1.5
	IA-19KK-22-22	22 X 1.5	22 X 1.5
	IA-19KK-24-24	24 X 1.5	24 X 1.5
	IA-19KK-30-30	30 X 1.5	30 X 1.5
	IA-19KK-33-33	33 X 1.5	33 X 1.5

WARNING This product can expose you to chemicals, which are known to the State of California to cause cancer or birth defects or other reproductive harm. For more information visit <https://www.p65warnings.ca.gov/>

IA-AKKK KOMATSU® MALE UNION TEE

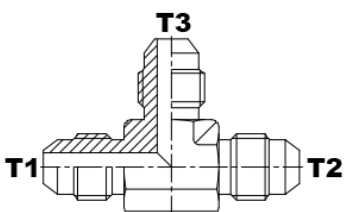
	PART NUMBER	T1	T2	T3
	IA-AKKK-14-14-14	14 X 1.5	14 X 1.5	14 X 1.5
	IA-AKKK-16-16-16	16 X 1.5	16 X 1.5	16 X 1.5
	IA-AKKK-18-18-18	18 X 1.5	18 X 1.5	18 X 1.5
	IA-AKKK-22-22-22	22 X 1.5	22 X 1.5	22 X 1.5
	IA-AKKK-24-24-24	24 X 1.5	24 X 1.5	24 X 1.5
	IA-AKKK-30-30-30	30 X 1.5	30 X 1.5	30 X 1.5
	IA-AKKK-33-33-33	33 X 1.5	33 X 1.5	33 X 1.5

IA-20KK KOMATSU® MALE x FEMALE SWIVEL

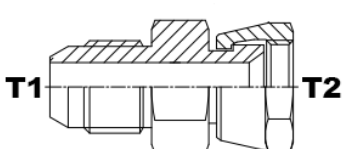
	PART NUMBER	T1	T2
	IA-20KK-14-14	14 X 1.5	14 X 1.5
	IA-20KK-16-16	16 X 1.5	16 X 1.5
	IA-20KK-18-18	18 X 1.5	18 X 1.5
	IA-20KK-20-20	20 X 1.5	20 X 1.5
	IA-20KK-22-22	22 X 1.5	22 X 1.5
	IA-20KK-24-24	24 X 1.5	24 X 1.5
	IA-20KK-30-30	30 X 1.5	30 X 1.5
	IA-20KK-33-33	33 X 1.5	33 X 1.5
	IA-20KK-36-36	36 X 1.5	36 X 1.5
	IA-20KK-42-42	42 X 1.5	42 X 1.5

IA-29KK KOMATSU® MALE x 90° FEMALE SWIVEL

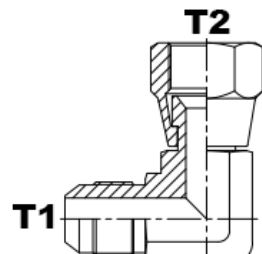
	PART NUMBER	T1	T2
	IA-29KK-14-14	14 X 1.5	14 X 1.5
	IA-29KK-16-16	16 X 1.5	16 X 1.5
	IA-29KK-18-18	18 X 1.5	18 X 1.5
	IA-29KK-22-22	22 X 1.5	22 X 1.5
	IA-29KK-24-24	24 X 1.5	24 X 1.5
	IA-29KK-30-30	30 X 1.5	30 X 1.5
	IA-29KK-33-33	33 X 1.5	33 X 1.5

IA-BKKK KOMATSU® MALE x FEMALE SWIVEL BR. TEE

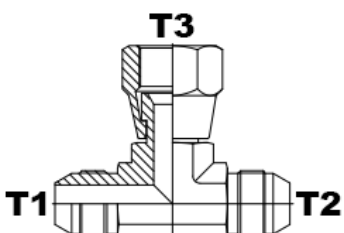
	PART NUMBER	T1	T2	T3
	IA-BKKK-14-14-14	14 X 1.5	14 X 1.5	14 X 1.5
	IA-BKKK-18-18-18	18 X 1.5	18 X 1.5	18 X 1.5
	IA-BKKK-22-22-22	22 X 1.5	22 X 1.5	22 X 1.5
	IA-BKKK-24-24-24	24 X 1.5	24 X 1.5	24 X 1.5
	IA-BKKK-30-30-30	30 X 1.5	30 X 1.5	30 X 1.5
	IA-BKKK-33-33-33	33 X 1.5	33 X 1.5	33 X 1.5

WARNING This product can expose you to chemicals, which are known to the State of California to cause cancer or birth defects or other reproductive harm. For more information visit <https://www.p65warnings.ca.gov/>

IA-CKKK KOMATSU® MALE x FEMALE SWIVEL RUN TEE

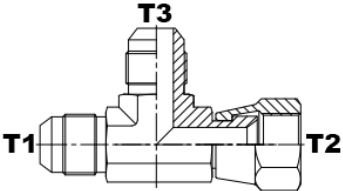
	PART NUMBER	T1	T2	T3
	IA-CKKK-14-14-14	14 X 1.5	14 X 1.5	14 X 1.5
	IA-CKKK-18-18-18	18 X 1.5	18 X 1.5	18 X 1.5
	IA-CKKK-22-22-22	22 X 1.5	22 X 1.5	22 X 1.5
	IA-CKKK-24-24-24	24 X 1.5	24 X 1.5	24 X 1.5
	IA-CKKK-30-30-30	30 X 1.5	30 X 1.5	30 X 1.5
	IA-CKKK-33-33-33	33 X 1.5	33 X 1.5	33 X 1.5

IA-DKKK KOMATSU® FEMALE SWIVEL TEE

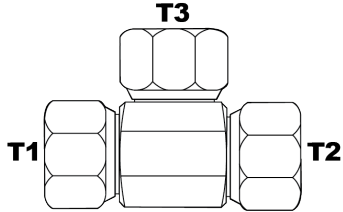
	PART NUMBER	T1	T2	T3
	IA-DKKK-14-14-14	14 X 1.5	14 X 1.5	14 X 1.5
	IA-DKKK-16-16-16	16 X 1.5	16 X 1.5	16 X 1.5
	IA-DKKK-18-18-18	18 X 1.5	18 X 1.5	18 X 1.5
	IA-DKKK-22-22-22	22 X 1.5	22 X 1.5	22 X 1.5
	IA-DKKK-24-24-24	24 X 1.5	24 X 1.5	24 X 1.5
	IA-DKKK-30-30-30	30 X 1.5	30 X 1.5	30 X 1.5
	IA-DKKK-33-33-33	33 X 1.5	33 X 1.5	33 X 1.5
	IA-DKKK-36-36-36	33 X 1.5	33 X 1.5	33 X 1.5
	IA-DKKK-42-42-42	42 X 1.5	42 X 1.5	42 X 1.5

IA-10KH KOMATSU® MALE x METRIC PORT MALE

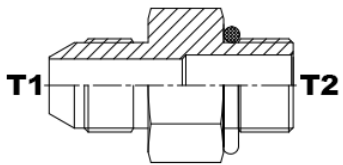
	PART NUMBER	T1	T2
	IA-10KH-14-12	14 X 1.5	12 X 1.5
	IA-10KH-14-14	14 X 1.5	14 X 1.5
	IA-10KH-18-14	18 X 1.5	14 X 1.5
	IA-10KH-18-16	18 X 1.5	16 X 1.5
	IA-10KH-18-20	18 X 1.5	20 X 1.5
	IA-10KH-22-20	22 X 1.5	20 X 1.5
	IA-10KH-24-22	24 X 1.5	22 X 1.5
	IA-10KH-30-27	30 X 1.5	27 X 2.0
	IA-10KH-33-33	33 X 1.5	33 X 2.0
	IA-10KH-36-33	36 X 1.5	33 X 2.0

IA-14KH KOMATSU® MALE x 45° METRIC PORT MALE ADJ.

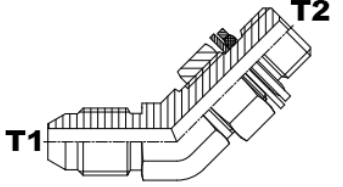
	PART NUMBER	T1	T2
	IA-14KH-14-12	14 X 1.5	12 X 1.5
	IA-14KH-16-14	16 X 1.5	14 X 1.5
	IA-14KH-18-14	18 X 1.5	14 X 1.5
	IA-14KH-18-16	18 X 1.5	16 X 1.5
	IA-14KH-18-20	18 X 1.5	20 X 1.5
	IA-14KH-20-18	20 X 1.5	18 X 1.5
	IA-14KH-22-20	22 X 1.5	20 X 1.5
	IA-14KH-24-22	24 X 1.5	22 X 1.5
	IA-14KH-30-20	30 X 1.5	20 X 1.5
	IA-14KH-30-24	30 X 1.5	24 X 1.5
	IA-14KH-33-33	33 X 1.5	33 X 2.0

WARNING This product can expose you to chemicals, which are known to the State of California to cause cancer or birth defects or other reproductive harm. For more information visit <https://www.p65warnings.ca.gov/>

IA-19KH

KOMATSU® MALE x 90° METRIC PORT MALE ADJ.

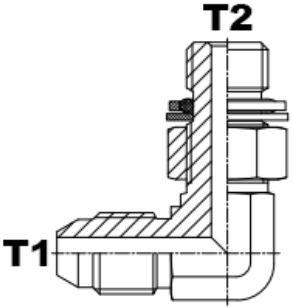
	PART NUMBER	T1	T2
	IA-19KH-14-12	14 X 1.5	12 X 1.5
IA-19KH-14-14	14 X 1.5	14 X 1.5	
IA-19KH-16-14	16 X 1.5	14 X 1.5	
IA-19KH-18-14	18 X 1.5	14 X 1.5	
IA-19KH-18-16	18 X 1.5	16 X 1.5	
IA-19KH-18-20	18 X 1.5	20 X 1.5	
IA-19KH-20-18	20 X 1.5	18 X 1.5	
IA-19KH-22-20	22 X 1.5	20 X 1.5	
IA-19KH-24-20	24 X 1.5	20 X 1.5	
IA-19KH-30-20	30 X 1.5	20 X 1.5	
IA-19KH-30-24	30 X 1.5	24 X 1.5	
IA-19KH-30-27	30 X 1.5	27 X 2.0	
IA-19KH-33-33	33 X 1.5	33 X 2.0	

IA-AKKH

KOMATSU® MALE x METRIC PORT MALE BR. TEE

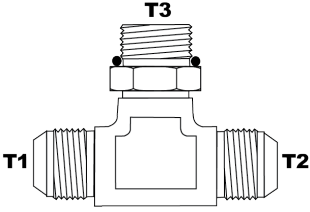
	PART NUMBER	T1	T2	T3
	IA-AKKH-14-14-12	14 X 1.5	14 X 1.5	12 X 1.5
IA-AKKH-14-14-14	14 X 1.5	14 X 1.5	14 X 1.5	
IA-AKKH-16-16-14	16 X 1.5	16 X 1.5	14 X 1.5	
IA-AKKH-18-18-14	18 X 1.5	18 X 1.5	14 X 1.5	
IA-AKKH-18-18-16	18 X 1.5	18 X 1.5	16 X 1.5	
IA-AKKH-18-18-20	18 X 1.5	18 X 1.5	20 X 1.5	
IA-AKKH-22-22-20	22 X 1.5	22 X 1.5	20 X 1.5	
IA-AKKH-24-24-20	24 X 1.5	24 X 1.5	20 X 1.5	
IA-AKKH-24-24-22	24 X 1.5	24 X 1.5	22 X 1.5	
IA-AKKH-30-30-27	30 X 1.5	30 X 1.5	27 X 2.0	
IA-AKKH-33-33-33	33 X 1.5	33 X 1.5	33 X 2.0	

IA-AKHK

KOMATSU® MALE x METRIC PORT MALE RUN TEE

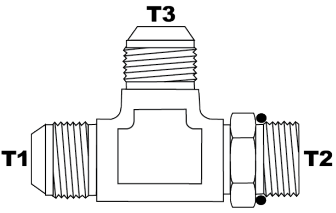
	PART NUMBER	T1	T2	T3
	IA-AKHK-14-12-14	14 X 1.5	12 X 1.5	14 X 1.5
IA-AKHK-14-14-14	14 X 1.5	14 X 1.5	14 X 1.5	
IA-AKHK-16-14-16	16 X 1.5	14 X 1.5	16 X 1.5	
IA-AKHK-18-14-18	18 X 1.5	14 X 1.5	18 X 1.5	
IA-AKHK-18-16-18	18 X 1.5	16 X 1.5	18 X 1.5	
IA-AKHK-18-20-18	18 X 1.5	20 X 1.5	18 X 1.5	
IA-AKHK-22-20-22	22 X 1.5	20 X 1.5	22 X 1.5	
IA-AKHK-24-20-24	24 X 1.5	20 X 1.5	24 X 1.5	
IA-AKHK-24-22-24	24 X 1.5	22 X 1.5	24 X 1.5	
IA-AKHK-30-27-30	30 X 1.5	27 X 2.0	30 X 1.5	
IA-AKHK-33-33-33	33 X 1.5	33 X 2.0	33 X 1.5	
IA-AKHK-36-33-36	36 X 1.5	33 X 2.0	36 X 1.5	

IA-10KT

KOMATSU® MALE x BSPT MALE

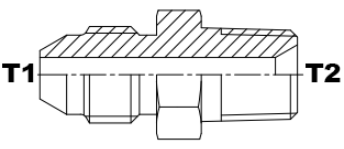
	PART NUMBER	T1	T2
	IA-10KT-14-04	14 X 1.5	1/4 - 19
IA-10KT-14-06	14 X 1.5	3/8 - 19	
IA-10KT-16-06	16 X 1.5	3/8 - 19	
IA-10KT-18-06	18 X 1.5	3/8 - 19	
IA-10KT-20-06	20 X 1.5	3/8 - 19	
IA-10KT-22-06	22 X 1.5	3/8 - 19	
IA-10KT-22-08	22 X 1.5	1/2 - 14	
IA-10KT-24-08	24 X 1.5	1/2 - 14	
IA-10KT-24-12	24 X 1.5	3/4 - 14	
IA-10KT-30-12	30 X 1.5	3/4 - 14	
IA-10KT-33-16	33 X 1.5	1 - 11	

WARNING This product can expose you to chemicals, which are known to the State of California to cause cancer or birth defects or other reproductive harm. For more information visit <https://www.p65warnings.ca.gov/>

IA-14KT KOMATSU® MALE x 45° BSPT MALE

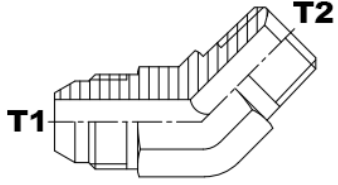
	PART NUMBER	T1	T2
	IA-14KT-14-04	14 X 1.5	1/4 - 19
IA-14KT-14-06	14 X 1.5	3/8 - 19	
IA-14KT-16-06	16 X 1.5	3/8 - 19	
IA-14KT-18-06	18 X 1.5	3/8 - 19	
IA-14KT-20-06	20 X 1.5	3/8 - 19	
IA-14KT-22-06	22 X 1.5	3/8 - 19	
IA-14KT-22-08	22 X 1.5	1/2 - 14	
IA-14KT-24-08	24 X 1.5	1/2 - 14	
IA-14KT-24-12	24 X 1.5	3/4 - 14	
IA-14KT-30-12	30 X 1.5	3/4 - 14	
IA-14KT-33-16	33 X 1.5	1 - 11	

IA-19KT KOMATSU® MALE x 90° BSPT MALE

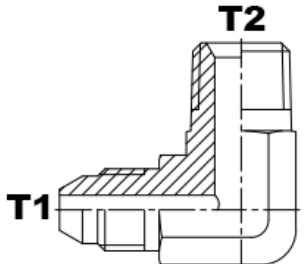
	PART NUMBER	T1	T2
	IA-19KT-14-02	14 X 1.5	1/8 - 28
IA-19KT-14-04	14 X 1.5	1/4 - 19	
IA-19KT-14-06	14 X 1.5	3/8 - 19	
IA-19KT-16-06	16 X 1.5	3/8 - 19	
IA-19KT-18-06	18 X 1.5	3/8 - 19	
IA-19KT-20-06	20 X 1.5	3/8 - 19	
IA-19KT-22-06	22 X 1.5	3/8 - 19	
IA-19KT-22-08	22 X 1.5	1/2 - 14	
IA-19KT-24-08	24 X 1.5	1/2 - 14	
IA-19KT-24-12	24 X 1.5	3/4 - 14	
IA-19KT-30-12	30 X 1.5	3/4 - 14	
IA-19KT-33-16	33 X 1.5	1 - 11	

IA-10KB KOMATSU® MALE x BSPP MALE

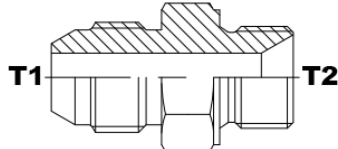
	PART NUMBER	T1	T2
	IA-10KB-14-04	14 X 1.5	1/4 - 19
IA-10KB-18-04	18 X 1.5	1/4 - 19	
IA-10KB-18-06	18 X 1.5	3/8 - 19	
IA-10KB-18-08	18 X 1.5	1/2 - 14	
IA-10KB-20-08	20 X 1.5	1/2 - 14	
IA-10KB-22-06	22 X 1.5	3/8 - 19	
IA-10KB-22-08	22 X 1.5	1/2 - 14	
IA-10KB-24-08	24 X 1.5	1/2 - 14	
IA-10KB-24-10	24 X 1.5	5/8 - 14	
IA-10KB-30-12	30 X 1.5	3/4 - 14	
IA-10KB-33-16	33 X 1.5	1 - 11	

IA-10KG KOMATSU® MALE x BSPP MALE PORT

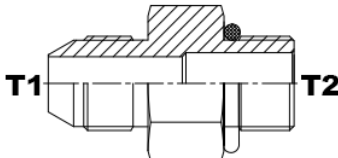
	PART NUMBER	T1	T2
	IA-10KG-14-04	14 X 1.5	1/4 - 19
IA-10KG-14-06	14 X 1.5	3/8 - 19	
IA-10KG-16-06	16 X 1.5	3/8 - 19	
IA-10KG-18-06	18 X 1.5	3/8 - 19	
IA-10KG-22-08	22 X 1.5	1/2 - 14	
IA-10KG-30-12	30 X 1.5	3/4 - 14	
IA-10KG-33-12	33 X 1.5	3/4 - 14	
IA-10KG-33-16	33 X 1.5	1 - 11	

WARNING This product can expose you to chemicals, which are known to the State of California to cause cancer or birth defects or other reproductive harm. For more information visit <https://www.p65warnings.ca.gov/>

IA-14KG

KOMATSU® MALE x 45° BSPP MALE PORT ADJ.

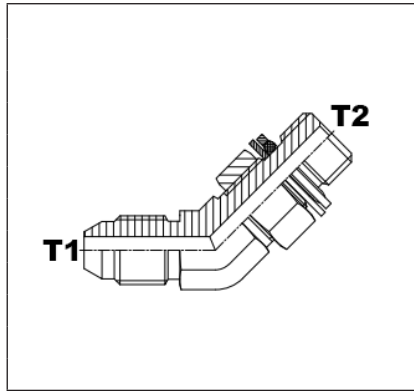

PART NUMBER	T1	T2
IA-14KG-14-04	14 X 1.5	1/4 - 19
IA-14KG-18-06	18 X 1.5	3/8 - 19
IA-14KG-22-08	22 X 1.5	1/2 - 14
IA-14KG-24-08	24 X 1.5	1/2 - 14
IA-14KG-30-12	30 X 1.5	3/4 - 14
IA-14KG-33-16	33 X 1.5	1 - 11

IA-19KG

KOMATSU® MALE x 90° BSPP MALE PORT ADJ.

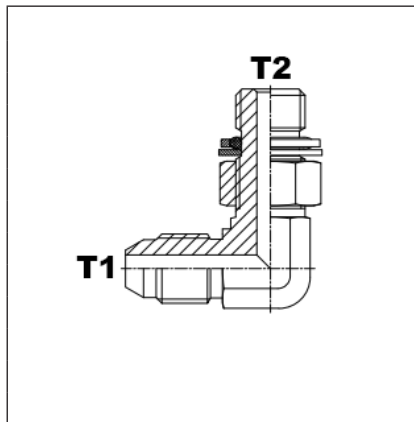

PART NUMBER	T1	T2
IA-19KG-14-04	14 X 1.5	1/4 - 19
IA-19KG-14-06	14 X 1.5	3/8 - 19
IA-19KG-16-06	16 X 1.5	3/8 - 19
IA-19KG-18-06	18 X 1.5	3/8 - 19
IA-19KG-20-06	20 X 1.5	3/8 - 19
IA-19KG-20-08	20 X 1.5	1/2 - 14
IA-19KG-22-08	22 X 1.5	1/2 - 14
IA-19KG-24-08	24 X 1.5	1/2 - 14
IA-19KG-24-12	24 X 1.5	3/4 - 14
IA-19KG-30-12	30 X 1.5	3/4 - 14
IA-19KG-33-16	33 X 1.5	1 - 11
IA-19KG-33-20	33 X 1.5	1 1/4 - 11

IA-10KN

KOMATSU® MALE x NPT MALE

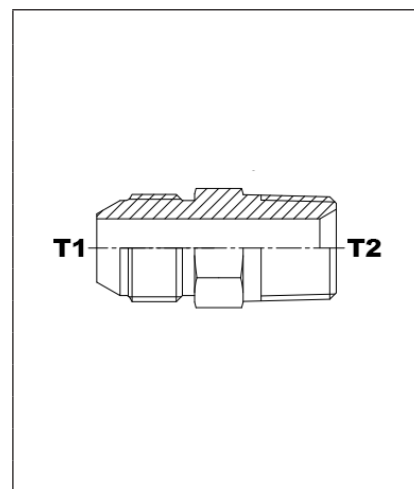

PART NUMBER	T1	T2
IA-10KN-14-04	14 X 1.5	1/4 - 18
IA-10KN-14-06	14 X 1.5	3/8 - 18
IA-10KN-16-06	16 X 1.5	3/8 - 18
IA-10KN-16-08	16 X 1.5	1/2 - 14
IA-10KN-18-06	18 X 1.5	3/8 - 18
IA-10KN-20-06	20 X 1.5	3/8 - 18
IA-10KN-20-08	20 X 1.5	1/2 - 14
IA-10KN-22-08	22 X 1.5	1/2 - 14
IA-10KN-24-08	24 X 1.5	1/2 - 14
IA-10KN-24-12	24 X 1.5	3/4 - 14
IA-10KN-30-12	30 X 1.5	3/4 - 14
IA-10KN-33-16	33 X 1.5	1 - 11 1/2
IA-10KN-36-20	36 X 1.5	1 1/4 - 11 1/2
IA-10KN-42-24	42 X 1.5	1 1/2 - 11 1/2

WARNING This product can expose you to chemicals, which are known to the State of California to cause cancer or birth defects or other reproductive harm. For more information visit <https://www.p65warnings.ca.gov/>

IA-19KN KOMATSU® MALE x 90° NPT MALE

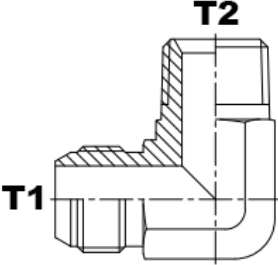
	PART NUMBER	T1	T2
	IA-19KN-14-04	14 X 1.5	1/4 - 18
IA-19KN-16-06	16 X 1.5	3/8 - 18	
IA-19KN-16-08	16 X 1.5	1/2 - 14	
IA-19KN-18-06	18 X 1.5	3/8 - 18	
IA-19KN-20-06	20 X 1.5	3/8 - 18	
IA-19KN-20-08	20 X 1.5	1/2 - 14	
IA-19KN-22-08	22 X 1.5	1/2 - 14	
IA-19KN-24-08	24 X 1.5	1/2 - 14	
IA-19KN-24-12	24 X 1.5	3/4 - 14	
IA-19KN-30-12	30 X 1.5	3/4 - 14	
IA-19KN-33-16	33 X 1.5	1 - 11 1/2	

IA-10JK JIC MALE x KOMATSU® MALE

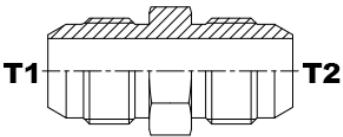
	PART NUMBER	T1	T2
	IA-10JK-04-14	7/16 - 20	14 X 1.5
IA-10JK-06-16	9/16 - 18	16 X 1.5	
IA-10JK-06-18	9/16 - 18	18 X 1.5	
IA-10JK-08-22	3/4 - 16	22 X 1.5	
IA-10JK-10-24	7/8 - 14	24 X 1.5	
IA-10JK-12-30	1 1/16 - 12	30 X 1.5	
IA-10JK-12-22	1 1/16 - 12	30 X 1.5	
IA-10JK-12-28	1 1/16 - 12	36 X 1.5	
IA-10JK-16-33	1 5/16 - 12	33 X 1.5	
IA-10JK-16-22	1 5/16 - 12	30 X 1.5	
IA-10JK-16-28	1 5/16 - 12	36 X 1.5	
IA-10JK-16-35	1 5/16 - 12	45 X 1.5	
IA-10JK-20-35	1 5/8 - 12	45 X 1.5	
IA-10JK-24-42	1 7/8 - 12	42 X 1.5	

IA-20KJ KOMATSU® MALE x JIC FEMALE SWIVEL

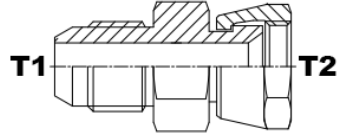
	PART NUMBER	T1	T2
	IA-20KJ-12-22	1 1/16 - 12	30 X 1.5
IA-20KJ-14-04	14 X 1.5	7/16 - 20	
IA-20KJ-16-28	1 5/16 - 12	36 X 1.5	
IA-20KJ-18-06	18 X 1.5	9/16 - 18	
IA-20KJ-20-35	1 5/8 - 12	45 X 1.5	
IA-20KJ-22-08	22 X 1.5	3/4 - 16	
IA-20KJ-22-12	22 X 1.5	1 1/16 - 12	
IA-20KJ-24-10	24 X 1.5	7/8 - 14	
IA-20KJ-24-12	24 X 1.5	1 1/16 - 12	
IA-20KJ-33-16	33 X 1.5	1 5/16 - 12	

IA-20JK JIC MALE x KOMATSU® FEMALE SWIVEL

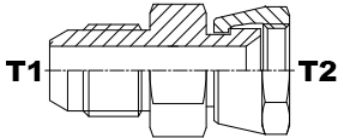
	PART NUMBER	T1	T2
	IA-20JK-04-14	7/16 - 20	14 X 1.5
IA-20JK-06-16	9/16 - 18	16 X 1.5	
IA-20JK-06-18	9/16 - 18	18 X 1.5	
IA-20JK-08-22	3/4 - 16	22 X 1.5	
IA-20JK-10-24	7/8 - 14	24 X 1.5	
IA-20JK-12-30	1 1/16 - 12	30 X 1.5	
IA-20JK-16-33	1 5/16 - 12	33 X 1.5	

⚠ WARNING This product can expose you to chemicals, which are known to the State of California to cause cancer or birth defects or other reproductive harm. For more information visit <https://www.p65warnings.ca.gov/>

IA-30JK JIC x KOMATSU® FEMALE SWIVEL

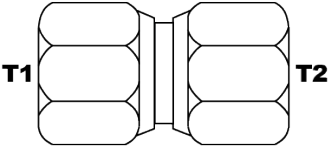
	PART NUMBER	T1	T2
	IA-30JK-12-22	1 1/16 - 12	22 X 1.5
	IA-30JK-12-24	1 1/16 - 12	24 X 1.5
	IA-30JK-12-30	1 1/16 - 12	30 X 1.5
	IA-30JK-16-33	1 5/16 - 12	33 X 1.5
	IA-30JK-24-42	1 7/8 - 12	42 X 1.5

IA-50JK JIC MALE x KOMATSU® FEMALE

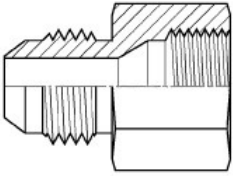
	PART NUMBER	T1	T2
	IA-50JK-04-14	7/16 - 20	14 X 1.5
	IA-50JK-06-18	9/16 - 18	18 X 1.5
	IA-50JK-08-22	3/4 - 16	22 X 1.5
	IA-50JK-10-24	7/8 - 14	24 X 1.5
	IA-50JK-12-30	1 1/16 - 12	30 X 1.5

IA-10FK ORFS MALE x KOMATSU® MALE

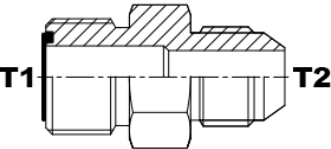
	PART NUMBER	T1	T2
	IA-10FK-04-14	9/16 - 18	14 X 1.5
	IA-10FK-06-18	11/16 - 16	18 X 1.5
	IA-10FK-08-22	13/16 - 16	22 X 1.5
	IA-10FK-10-24	1 - 14	24 X 1.5
	IA-10FK-12-30	1 3/16 - 12	30 X 1.5
	IA-10FK-16-33	1 7/16 - 12	33 X 1.5

IA-20FK ORFS MALE x KOMATSU® FEMALE SWIVEL

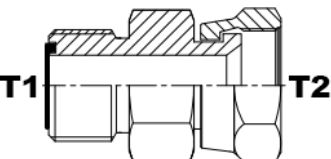
	PART NUMBER	T1	T2
	IA-20FK-04-14	9/16 - 18	14 X 1.5
	IA-20FK-06-18	11/16 - 16	18 X 1.5
	IA-20FK-08-22	13/16 - 16	22 X 1.5
	IA-20FK-10-24	1 - 14	24 X 1.5
	IA-20FK-12-30	1 3/16 - 12	30 X 1.5
	IA-20FK-16-33	1 7/16 - 12	33 X 1.5

WARNING This product can expose you to chemicals, which are known to the State of California to cause cancer or birth defects or other reproductive harm. For more information visit <https://www.p65warnings.ca.gov/>

IA-0SX KOBELCO® METRIC TUBE BITE SLEEVE

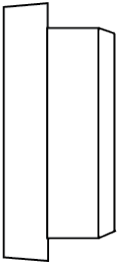
	PART NUMBER	T1	TUBE	OD
	IA-0SX-22	22 X 1.5	22	30
	IA-0SX-28	28 X 1.5	28	36
	IA-0SX-35	35 X 1.5	35	45

IA-0NX KOBELCO® METRIC TUBE NUT

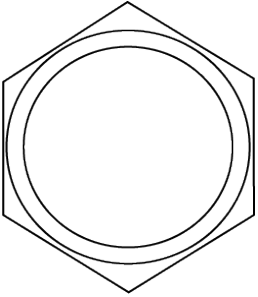
	PART NUMBER	T1
	IA-0NX-22	30 X 1.5
	IA-0NX-28	36 X 1.5
	IA-0NX-35	45 X 1.5

IA-0CX KOBELCO® FEMALE CAP

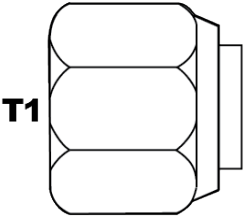
	PART NUMBER	T1
	IA-0CX-22	30 X 1.5
	IA-0CX-28	36 X 1.5
	IA-0CX-35	45 X 1.5

IA-0PX KOBELCO® MALE PLUG

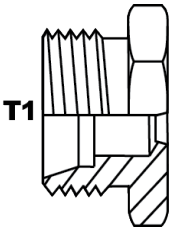
	PART NUMBER	T1
	IA-0PX-22	30 X 1.5
	IA-0PX-28	36 X 1.5
	IA-0PX-35	45 X 1.5

WARNING This product can expose you to chemicals, which are known to the State of California to cause cancer or birth defects or other reproductive harm. For more information visit <https://www.p65warnings.ca.gov/>

IA-10JX

JIC MALE x KOBELCO® MALE

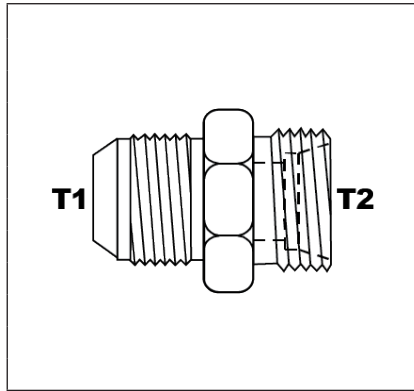

PART NUMBER	T1	T2
IA-10JX-12-22	1 1/16 - 12	22 X 1.5
IA-10JX-12-28	1 1/16 - 12	28 X 1.5
IA-10JX-16-22	1 5/16 - 12	22 X 1.5
IA-10JX-16-28	1 5/16 - 12	28 X 1.5
IA-10JX-16-35	1 5/16 - 12	35 X 1.5
IA-10JX-20-35	1 5/8 - 12	35 X 1.5

IA-20JX

JIC MALE x KOBELCO® FEMALE

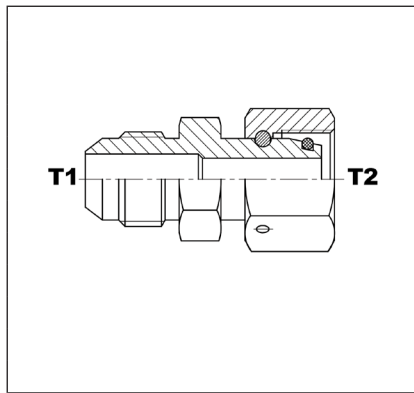

PART NUMBER	T1	T2
IA-20JX-12-22	1 1/16 - 12	22 X 1.5
IA-20JX-16-28	1 5/16 - 12	28 X 1.5
IA-20JX-20-35	1 5/8 - 12	35 X 1.5

WARNING This product can expose you to chemicals, which are known to the State of California to cause cancer or birth defects or other reproductive harm. For more information visit <https://www.p65warnings.ca.gov/>

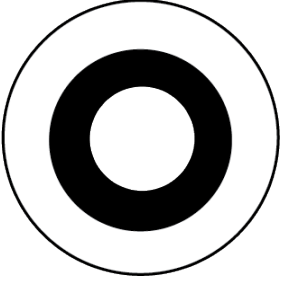

IA-BBS BSP BONDED SEAL

	PART NUMBER	OD (in)	ID (in)	WIDTH
	IA-BBS-02	0.625	0.408	0.080
	IA-BBS-04	0.810	0.541	0.080
	IA-BBS-06	0.937	0.680	0.080
	IA-BBS-08	1.125	0.848	0.098
	IA-BBS-10	1.250	0.925	0.098
	IA-BBS-12	1.375	1.065	0.098
	IA-BBS-16	1.685	1.334	0.098
	IA-BBS-20	2.062	1.690	0.128
	IA-BBS-24	2.307	1.907	0.128
	IA-BBS-32	2.875	2.385	0.128
	IA-BBS-48	4.113	3.507	0.128
	IA-BBS-04-SS	0.810	0.541	0.080
	IA-BBS-08-SS	1.125	0.848	0.098
	IA-BBS-12-SS	1.375	1.065	0.098
	IA-BBS-16-SS	1.685	1.334	0.098
	IA-BBS-10-SS-V	1.250	0.925	0.098
IA-BBS-24-SS-V	2.307	1.907	0.128	

*Note: -SS indicates Stainless Steel; -V indicates Viton seal material (Buna is standard).

IA-MBS METRIC BONDED SEAL

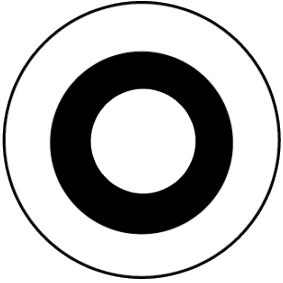
	PART NUMBER	OD (in)	ID (in)	WIDTH
	IA-MBS-06	10.00	6.70	1.00
	IA-MBS-08	13.00	8.70	1.00
	IA-MBS-10	15.88	10.35	1.50
	IA-MBS-12	18.00	12.70	1.50
	IA-MBS-14	22.00	14.70	1.50
	IA-MBS-16	24.00	16.70	1.50
	IA-MBS-18	26.00	18.70	1.50
	IA-MBS-20	28.00	20.70	1.50
	IA-MBS-22	30.00	22.70	2.00
	IA-MBS-24	32.00	24.70	2.00
	IA-MBS-26	35.00	26.70	2.00
	IA-MBS-27	36.00	27.20	2.00
	IA-MBS-30	39.00	31.00	2.00
	IA-MBS-33	42.00	33.70	2.00
	IA-MBS-42	53.00	42.70	2.00
	IA-MBS-48	59.00	48.70	3.00
	IA-MBS-12-SS	18.00	12.70	1.50
	IA-MBS-14-SS	22.00	14.70	1.50
	IA-MBS-18-SS	26.00	18.70	1.50
	IA-MBS-12-SS-V	18.00	12.70	1.50
	IA-MBS-14-SS-V	22.00	14.70	1.50
	IA-MBS-18-SS-V	26.00	18.70	1.50
	IA-MBS-20-SS-V	28.00	20.70	1.50
	IA-MBS-22-SS-V	30.00	22.70	2.00



WARNING This product can expose you to chemicals, which are known to the State of California to cause cancer or birth defects or other reproductive harm. For more information visit <https://www.p65warnings.ca.gov/>

IA-BRR

BSPP RETAINING RING

	PART NUMBER	OD (in)	WIDTH
	IA-BRR-02	0.591	0.055
	IA-BRR-04	0.768	0.075
	IA-BRR-06	0.925	0.075
	IA-BRR-08	1.122	0.075
	IA-BRR-12	1.358	0.102
	IA-BRR-16	1.713	0.102
	IA-BRR-20	2.067	0.102
	IA-BRR-24	2.362	0.102
	IA-BRR-12-SS	1.358	0.102

*Note: -SS indicates Stainless Steel.

IA-BOR

BSPP O-RING

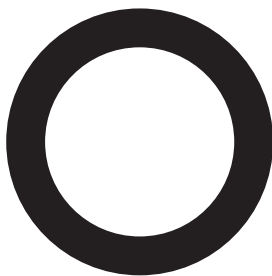
	PART NUMBER	ID (in)	WIDTH
	IA-BOR-02	0.315	0.079
	IA-BOR-04	0.424	0.103
	IA-BOR-06	0.549	0.103
	IA-BOR-08	0.707	0.103
	IA-BOR-12	0.924	0.103
	IA-BOR-16	1.171	0.139
	IA-BOR-20	1.484	0.139
	IA-BOR-24	1.734	0.139

IA-MRR

METRIC RETAINING RING

	PART NUMBER	OD (in)	WIDTH
	IA-MRR-08	13.150	1.000
	IA-MRR-10	14.750	1.000
	IA-MRR-12	17.750	1.300
	IA-MRR-14	19.750	1.300
	IA-MRR-16	21.750	1.500
	IA-MRR-18	23.750	2.000
	IA-MRR-20	25.750	1.300
	IA-MRR-22	27.750	1.300
	IA-MRR-24	29.750	1.300
	IA-MRR-26	31.750	2.000
	IA-MRR-27	32.750	2.000
	IA-MRR-30	36.320	2.000
	IA-MRR-33	39.750	2.000
	IA-MRR-36	42.750	2.000
	IA-MRR-42	49.750	2.000
	IA-MRR-45	52.750	2.000
	IA-MRR-48	54.950	2.000

 **WARNING** This product can expose you to chemicals, which are known to the State of California to cause cancer or birth defects or other reproductive harm. For more information visit <https://www.p65warnings.ca.gov/>



IA-MOR

METRIC O-RING

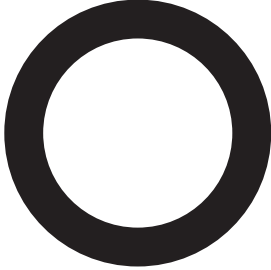
	PART NUMBER	ID (in)	WIDTH
	IA-MOR-08	6.07	1.63
	IA-MOR-10	8.00	1.50
	IA-MOR-12	9.25	1.78
	IA-MOR-14	10.82	1.78
	IA-MOR-16	13.46	2.08
	IA-MOR-18	15.54	2.62
	IA-MOR-20	17.17	1.78
	IA-MOR-22	18.77	1.78
	IA-MOR-24	20.35	1.78
	IA-MOR-26	21.89	2.62
	IA-MOR-27	23.47	2.62
	IA-MOR-30	26.64	2.62
	IA-MOR-33	28.24	2.62
	IA-MOR-36	31.42	2.62
	IA-MOR-42	37.77	2.62
IA-MOR-45	40.94	2.62	
IA-MOR-48	44.12	2.62	

IA-BCS

BSPP CAPTIVE SEAL

	PART NUMBER	OD (in)	ID (in)	WIDTH
	IA-BCS-02	0.469	0.331	0.039
	IA-BCS-04	0.650	0.457	0.059
	IA-BCS-06	0.744	0.579	0.059
	IA-BCS-08	0.941	0.728	0.059
	IA-BCS-12	1.150	0.941	0.059
	IA-BCS-16	1.406	1.169	0.079
	IA-BCS-20	1.803	1.528	0.079
	IA-BCS-24	1.996	1.760	0.079

IA-MCS

METRIC CAPTIVE SEAL

	PART NUMBER	OD (in)	ID (in)	WIDTH
	IA-MCS-08	9.90	6.50	1.00
	IA-MCS-10	11.90	8.40	1.00
	IA-MCS-12	14.40	9.80	1.50
	IA-MCS-14	16.50	11.60	1.50
	IA-MCS-16	18.90	13.80	1.50
	IA-MCS-18	20.90	15.70	1.50
	IA-MCS-20	22.90	17.80	1.50
	IA-MCS-22	24.30	19.60	1.50
	IA-MCS-26	29.20	23.90	1.50
	IA-MCS-27	29.20	23.90	1.50
	IA-MCS-33	35.70	29.70	2.00
	IA-MCS-42	45.80	38.80	2.00
	IA-MCS-48	50.70	44.70	2.00

WARNING This product can expose you to chemicals, which are known to the State of California to cause cancer or birth defects or other reproductive harm. For more information visit <https://www.p65warnings.ca.gov/>

IA-DOR DIN CONE O-RING (DKO)

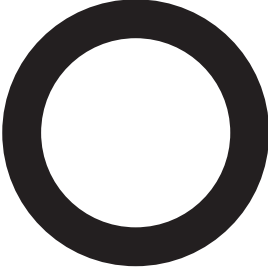
	PART NUMBER	ID (in)	WIDTH
	IA-DOR-06	4.50	1.50
	IA-DOR-08	6.50	1.50
	IA-DOR-10	8.00	1.50
	IA-DOR-12	10.00	1.50
	IA-DOR-14	11.00	2.00
	IA-DOR-15	12.00	2.00
	IA-DOR-16	13.00	2.00
	IA-DOR-18	15.00	2.00
	IA-DOR-20	16.30	2.40
	IA-DOR-22	20.00	2.00
	IA-DOR-25	20.30	2.40
	IA-DOR-28	26.00	2.00
	IA-DOR-30	25.30	2.40
	IA-DOR-35	32.00	2.50
IA-DOR-38	33.30	2.40	
IA-DOR-42	38.00	2.50	

IA-SOR JIS PORT O-RING

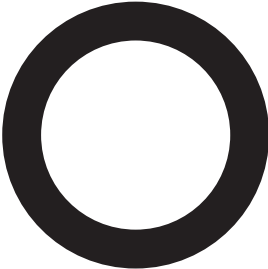
	PART NUMBER	ID (in)	WIDTH
	IA-SOR-02	0.307	0.075
	IA-SOR-04	0.425	0.094
	IA-SOR-06	0.543	0.094
	IA-SOR-08	0.701	0.094
	IA-SOR-12	0.933	0.138
	IA-SOR-16	1.130	0.138

 **WARNING** This product can expose you to chemicals, which are known to the State of California to cause cancer or birth defects or other reproductive harm. For more information visit <https://www.p65warnings.ca.gov/>

IA-0XBS

BSPP TO JIS CONVERSION SEAT

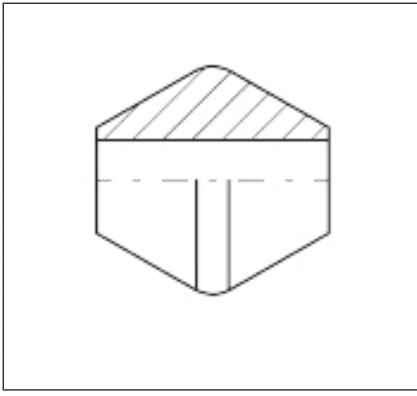

PART NUMBER
IA-0XBS-02
IA-0XBS-04
IA-0XBS-06
IA-0XBS-08
IA-0XBS-10
IA-0XBS-12
IA-0XBS-16
IA-0XBS-20
IA-0XBS-24

IA-0XFS

BSPP FF TO JIS CONVERSION SEAT

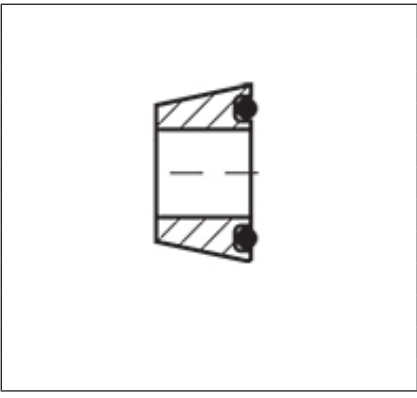

PART NUMBER
IA-0XFS-06
IA-0XFS-08

⚠ WARNING This product can expose you to chemicals, which are known to the State of California to cause cancer or birth defects or other reproductive harm. For more information visit <https://www.p65warnings.ca.gov/>



Corporate Contact Information:

50 Industrial Loop North
Orange Park FL, 32073

(904) 264-1267

04082022

WWW.FLEXTRAL.COM

2nd Edition